

**Mededeling van de Raad van het BIPT
van 19 december 2023
betreffende
de conformiteit van het kostentoe rekeningssysteem
van Proximus voor het jaar 2021**

INHOUDSOPGAVE

1. VOORWERP.....	3
2. RETROACTA.....	4
3. JURIDISCHE BASIS.....	5
4. VASTSTELLINGEN VAN HET BIPT.....	6
5. HANDTEKENINGEN.....	7
Bijlage 1: Conclusie van de bedrijfsrevisor voor het jaar 2019.....	8

1. VOORWERP

1. Met deze mededeling publiceert het BIPT, gebaseerd op het controleverslag van de bedrijfsrevisor die hiervoor werd aangesteld, de overeenstemmingsverklaring voor het kostentoerekeningssysteem van Proximus voor het jaar 2021, ter uitvoering van het besluit van 22 augustus 2007 betreffende de nadere regels met betrekking tot de verplichting tot kostentoerekening van Proximus (hierna: besluit van 22 augustus 2007)¹ overeenkomstig de artikelen 62, § 4, en 64, § 2, van de wet van 13 juni 2005 betreffende de elektronische communicatie WEC gewijzigd bij de wet van 21 december 2021 houdende omzetting van het Europees Wetboek voor elektronische communicatie en wijziging van diverse bepalingen inzake elektronische communicatie (hierna de wet van 13 juni 2005) ².
2. Een kostentoerekeningssysteem (of *cost accounting system*) is een geheel van regels aan de hand waarvan de kosten, inkomsten en ingezet kapitaal van een onderneming over haar verschillende diensten en activiteiten kunnen worden verdeeld. Het kostentoerekeningssysteem omvat met name de middelen (processen, basisgegevens, procedures...) waarmee de onderneming de nodige informatie kan registreren om te voldoen aan zijn wettelijke en reglementaire verplichtingen, met name door zijn inkomsten, kosten, activa en kapitaal blijvend te traceren. Het kostentoerekeningssysteem moet de regulator in staat stellen om over informatie te beschikken over de kosten van de diensten die aan regulering onderworpen zijn, en op die basis te bepalen of een operator zijn wettelijke en reglementaire verplichtingen is nagekomen.

¹ Besluit van het BIPT van 22 augustus 2007 met betrekking tot de uitvoering van de verplichting voor Proximus om een kostentoerekeningssysteem in te stellen.

² Wet van 13 juni 2005 betreffende de elektronische communicatie, *B.S.* 20 juni 2005, 28070.

2. RETROACTA

3. Proximus heeft op 7 augustus 2023 het BIPT de volgende documenten bezorgd:
 - Het verslag van opdracht van onafhankelijke verzekering van de auditeur met betrekking tot het systeem voor kostentoerekening opgesteld door Proximus;
 - De vertrouwelijke versie van de functionele documentatie;
 - De openbare versie van deze functionele documentatie;
 - Het gedetailleerde en vertrouwelijke verslag van de werkzaamheden van de onafhankelijke auditeur.

3. JURIDISCHE BASIS

4. Artikel 62, § 4, van de wet van 13 juni 2005 bepaalt dat *"wanneer het door het Instituut toegepaste kostentoerekeningssysteem dit noodzakelijk maakt, een door de operator aangeduide erkende bedrijfsrevisor op kosten van de operator toeziet op de inachtneming van het kostentoerekeningssysteem. Volgend op het rapport van die bedrijfsrevisor publiceert het Instituut ieder jaar een verklaring betreffende de inachtneming van het systeem"*.
5. Naar aanleiding van verschillende besluiten van de Raad van het BIPT werd de verplichting op Proximus opgelegd om een kostentoerekeningssysteem op te zetten. Tabel 1 geeft weer op welke markten en via welke marktanalysebesluiten een verplichting tot kostentoerekeningssysteem was opgelegd op Proximus.

Relevante markten ³		Besluiten van het BIPT
2014 - 3a	Lokale toegang op wholesaleniveau	29/06/2018 ⁴
2014 - 3b	Centrale toegang op wholesaleniveau	29/06/2018 ⁵
2014 - 4	Markt voor hoogwaardige toegang	13/12/2019

Tabel 1: Overzicht van de markten waarop op Proximus een kostentoerekeningsverplichting werd opgelegd

6. De besluiten van het BIPT van 29 juni 2018⁶ (bijlage H) en van 13 december 2019 (bijlage B) hebben de voorwaarden bepaald waaraan Proximus moet voldoen bij de toepassing van zijn kostentoerekeningssysteem. Die voorwaarden hebben betrekking op de algemene principes, de kwaliteit van de informatie, de toerekenings- en evaluatieregels, de documentatie, de beschrijving en de controle van het kostentoerekeningssysteem, alsook op de na te leven termijnen.

³ Hier genummerd in overeenstemming met de Aanbeveling van de Commissie van 9 oktober 2014 betreffende relevante producten- en dienstenmarkten in de elektronischecommunicatiesector die overeenkomstig Richtlijn 2002/21/EG van het Europees Parlement en de Raad inzake een gemeenschappelijk regelgevingskader voor elektronischecommunicatienetwerken en -diensten aan regelgeving ex ante kunnen worden onderworpen.

⁴ Zoals gecorrigeerd door het corrigendum van 11 juli 2018 met betrekking tot de beslissingen van de CRC van 29 juni 2018

⁵ Zoals gecorrigeerd door het corrigendum van 11 juli 2018 met betrekking tot de beslissingen van de CRC van 29 juni 2018

⁶ Besluit van de Raad van het BIPT van 29 juni 2018 betreffende de analyse van de markten voor breedband en televisieomroep en het besluit van de Raad van het BIPT van 13 december 2019 betreffende de analyse van de markt voor hoogwaardige toegang

4. VASTSTELLINGEN VAN HET BIPT

7. Het BIPT heeft nagekeken of de opdracht die Proximus aan de bedrijfsrevisor heeft toevertrouwd, voldeed aan de voorschriften van deel 8.2 van het besluit van het BIPT van 22 augustus 2007, namelijk: de relevantie verifiëren van de omtrek van de kosten en inkomsten, de inachtneming van de basisvereisten verifiëren, de toepassing van de toewijzings- en evaluatieregels verifiëren en een verslag overleggen aan het BIPT over de uitvoering van zijn opdracht.
8. Het BIPT heeft vastgesteld dat Proximus de uitvoering van de audit had toevertrouwd aan Deloitte Bedrijfsrevisoren.
9. Het BIPT heeft vastgesteld dat de inhoud van de functionele documentatie en van de openbare beschrijving van het kostentoerekeningssysteem voldeed aan de voorschriften van de delen 6.3 (Toepasselijke regels en voor te bereiden documentatie) en 7 (Beschrijving van het kostentoerekeningssysteem) van het besluit van het BIPT van 22 augustus 2007.
10. Overeenkomstig het besluit van 22 augustus 2007 (deel 8.2.3) moet de bedrijfsrevisor nagaan of de toegepaste toewijzings- en herwaarderingsregels wel beantwoorden aan de documentatie die door Proximus is voorbereid en aan de beschrijving van het kostentoerekeningssysteem.
11. Op basis van de controleverslagen van de bedrijfsrevisor concludeert het BIPT dat het Proximus-kostentoerekeningssysteem voor het jaar 2021 in alle opzichten voldoet aan alle materiële aspecten, aan het wettelijk kader dat werd vastgelegd door de wet van 13 juni 2005 en het besluit van het BIPT van 22 augustus 2007.
12. De conclusies van de bedrijfsrevisor voor 2021 zijn opgenomen in bijlage 1 bij deze mededeling.
13. In bijlage 2 wordt een beschrijving van het kostentoerekeningssysteem van Proximus van 2021, opgesteld door Proximus, weergegeven.

5. HANDTEKENINGEN

Axel Desmedt
lid van de Raad

Bernardo Herman
lid van de Raad

Luc Vanfleteren
lid van de Raad

Michel Van Bellinghen
voorzitter van de Raad

Bijlage 1: Conclusie van de bedrijfsrevisor voor het jaar 2021

Onafhankelijk assurance verslag inzake het beperkt nazicht van het Kostentoerekeningssysteem voor het jaar eindigend op 31 december 2021

Aan de raad van bestuur en de directie van Proximus NV van publiek recht

Opdracht

Wij hebben de eer u verslag uit te brengen over de uitvoering van de assurance opdracht van beperkt nazicht die ons werd toevertrouwd door Proximus NV van publiek recht (de "Vennootschap") in het kader van haar wettelijke verplichtingen met betrekking tot het Kostentoerekeningssysteem voor het boekjaar afgesloten op 31 december 2021 (het "Kostentoerekeningssysteem"). Dit Kostentoerekeningssysteem is door de Vennootschap gedocumenteerd in bijgevoegd rapport "Proximus Regulatory Cost Model 2021 – General description".

Wij hebben de van toepassing zijnde besluiten van het Belgisch Instituut voor Post- en Telecommunicatie (het "BIPT") evenals de toepasselijke wetgeving gehanteerd als toetsingskader voor onze opdracht, met name:

- Wet van 13 juni 2005 betreffende de elektronische communicatie, zoals (onder meer) gewijzigd door de wet van 18 mei 2009 en de wet van 10 juli 2012;
- Besluit van de Raad van het BIPT van 22 augustus 2007 betreffende de uitvoering van de verplichting voor Proximus om een kostentoerekeningssysteem in te stellen;
- Belgische Wet van 5 mei 2017 betreffende de audiovisuele mediadiensten in het tweetalig gebied Brussel-Hoofdstad;
- Het besluit van de Raad van het BIPT van 29 juni 2018 betreffende de analyse van de markten voor breedband en televisieoproep.

Deze wetten en besluiten (het "Wettelijk Kader") zijn als criteria gebruikt in de evaluatie van het Kostentoerekeningssysteem.

Verantwoordelijkheid van de directie en de raad van bestuur

Het opstellen van het Kostentoerekeningssysteem is de verantwoordelijkheid van de directie en de raad van bestuur van de Vennootschap. Deze verantwoordelijkheid omvat onder meer het ontwerp en de toepassing van een kostentoerekeningssysteem dat beantwoordt aan de basisprincipes van causaliteit, objectiviteit, consistentie en transparantie zoals voorgeschreven in het hoger vermeld Wettelijk Kader.

Verantwoordelijkheid van de commissaris

Het is onze verantwoordelijkheid om op basis van onze werkzaamheden van beperkt nazicht een oordeel tot uitdrukking te brengen over het Kostentoerekeningssysteem opgemaakt door Proximus NV van publiek recht voor het jaar eindigend op 31 december 2021. Wij hebben de assurance opdracht van beperkt nazicht over het Kostentoerekeningssysteem uitgevoerd overeenkomstig de International Standard on Assurance Engagements (ISAE 3000), van toepassing op assurance opdrachten van beperkt nazicht.

Reikwijdte van een assurance opdracht van beperkt nazicht

Een beperkt nazicht van het Kostentoerekeningssysteem, uitgevoerd overeenkomstig de International Standard on Assurance Engagements (ISAE 3000), bestaat uit het verzoeken om inlichtingen, in hoofdzaak bij de personen verantwoordelijk voor regulatoire en financiële aangelegenheden, alsmede uit het uitvoeren van cijferanalyses en andere werkzaamheden van beperkt nazicht.

Onze belangrijkste werkzaamheden in dit beperkt nazicht bestonden uit:

- Het aansluiten van de gegevens weerhouden in de kostenbasis in het Kostentoerekeningssysteem met de jaarrekening van Proximus NV van publiek recht per 31 december 2021;
- Het identificeren van de belangrijkste wijzigingen in de methodes tot herwaardering van de vaste activa in 2021 ten opzichte van 2020 en het bespreken hiervan met de directie;
- Het identificeren van de belangrijkste wijzigingen in het Kostentoerekeningssysteem van 2021 ten opzichte van 2020 en het bespreken hiervan met de directie;
- Het identificeren van wijzigingen in verdeelsleutels ten opzichte van 2020 en het bespreken hiervan met de directie, waarbij werd getoetst of de principes van causaliteit, objectiviteit, consistentie en transparantie worden nageleefd;
- Voor een selectie van verdeelsleutels:
 - Vergelijken van de verdeelde kosten per verdeelsleutel ten opzichte van de vooropgestelde verwachting;
 - Vergelijken van de deler van de verdeelsleutel ten opzichte van de vooropgestelde verwachting;
- Een horizontale analyse van het Kostentoerekeningssysteem waarbij de uitkomst van de kostentoerekening per kostenplaats vergeleken wordt ten opzichte van de vooropgestelde verwachting van kostentoerekening per kostenplaats en de verschillen besproken worden met de directie.

De reikwijdte van een beperkt nazicht, gericht op het verkrijgen van een beperkte mate van zekerheid, is aanzienlijk geringer dan die van een assurance opdracht gericht op het verkrijgen van een redelijke mate van zekerheid overeenkomstig de International Standard on Assurance Engagements (ISAE 3000). Om die reden stelt het beperkt nazicht ons niet in staat de zekerheid te verkrijgen dat wij kennis zullen krijgen van alle aangelegenheden van materieel belang die naar aanleiding van een controle mogelijk worden onderkend. Bijgevolg brengen wij geen controle-oordeel tot uitdrukking over het Kostentoerekeningssysteem.

Conclusie

Gebaseerd op het door ons uitgevoerde beperkt nazicht, kwamen er geen feiten onder onze aandacht welke ons doen geloven dat het Kostentoerekeningsstelsel opgemaakt door Proximus NV van publiek recht voor het jaar eindigend op 31 december 2021, niet, in alle materiële opzichten, is opgesteld overeenkomstig de bepalingen van het Wettelijk Kader.

Dit verslag is opgesteld in het kader van de verplichtingen van de Vennootschap onder het Wettelijk Kader en mag niet voor andere doeleinden worden gebruikt.

Getekend te Zaventem.

De commissaris

Digitally signed by
Koen Neijens Signed By: Koen Neijens (Signature)
Signing Time: 04-aug-2023 | 12:58 CEST

 **DocuSign** C: BE
Issuer: Citizen CA

2A8E2DCFD59C4E1FB8A5EA30AB0224A5

Deloitte Bedrijfsrevisoren BV

Vertegenwoordigd door Koen Neijens

Bijlage: Proximus Regulatory Cost Model 2021 – General description

**Bijlage 2: Beschrijving van het
kostoerekeningssysteem van Proximus voor 2021**



Proximus Regulatory Cost Model 2021

General Description

Authors:

DECHEVRE Agnès

DIEU Peter

DOOMS Françoise

GORSHECHNIKOVA Anastasiia

NYSENS Cécile

VANDENPLAS Danny

TABLE OF CONTENTS

1	GENERAL DESCRIPTION	5
2	MODEL ALLOCATION STRUCTURE	7
3	COST BASE.....	10
3.1	Cost model perimeter	10
3.1.1	Determination of the Cost model perimeter.....	10
3.1.2	Costs excluded from the Cost model perimeter.....	10
3.2	Cost regrouping	11
3.3	Organization	12
3.4	Assets revaluation.....	15
3.4.1	Decision tree.....	15
3.4.1.1	Split network - SCF and IT assets	15
3.4.2	Methods used to reevaluate the network assets	15
3.4.2.1	Inventory	16
3.4.2.2	Keep as it is.....	17
3.4.2.3	Asset valuation based on BIPT bottom-up cost models	17
3.4.3	TAM: Tilted Annuity Method	18
3.4.3.1	Theory.....	18
4	SCF (SUPPORT AND CUSTOMER FLOW) STREAM	21
4.1	Allocation of the support costs	21
4.1.1	Support Scope.....	21
4.1.2	Support Cost Objects.....	22
4.1.3	Asset Support Allocation	24
4.1.4	Allocation From the support module	26
4.1.5	Fleet case.....	27
4.1.6	Buildings Support costs :	29
4.1.6.1	Global picture of the allocation:.....	29
4.1.6.2	Source of the buildings costs :	29
4.1.6.3	Drivers used for the allocation	30
4.1.6.3.1	The SQM (Tower included or excluded).	30
4.1.6.3.2	Direct:.....	31
4.1.6.3.3	FTE Template completion.....	31
4.1.6.4	The Destination of the BUI related costs :	31
4.1.7	The power Key:.....	31
4.1.8	Allocation of the Network building related costs : CP_Technical_Buildings.....	33
4.1.8.1	Allocation Flow :	33

4.2	Allocation of the retail costs of the Consumer and Enterprise Business units	34
4.2.1	Retail costs perimeter	34
4.2.2	Retail costs allocation principles	35
4.2.2.1	Introduction of 2 cost type attributes	35
4.2.2.2	Criteria for attribute dimension VAR_TYPE	35
4.2.2.3	Criteria for attribute dimension PS_TYPE.....	36
4.2.2.4	Allocation of retail costs to Markets	38
4.2.3	Retail costs allocation flows.....	38
4.2.3.1	General principles.....	38
4.2.3.2	Retail FTE related costs (block 1)	40
4.2.3.3	Retail Support costs (block 2)	43
4.2.3.4	Retail costs which do not have a causal relationship with products (block 3)	44
4.2.3.5	Retail costs which have a causal relationship with products (block 4).....	45
4.3	Allocation of the CWS (Customer Wholesale division) costs.....	47
4.3.1	Wholesale costs perimeter	47
4.3.2	Wholesale costs allocation principles	48
4.3.2.1	Introduction of 2 cost type attributes	48
4.3.2.2	Criteria for attribute dimension VAR_TYPE	48
4.3.2.3	Criteria for attribute dimension PS_TYPE.....	48
4.3.2.4	Allocation of wholesale costs to Markets.....	49
4.3.3	Wholesale costs allocation flows	50
4.3.3.1	General principles.....	50
4.3.3.2	Wholesale FTE related costs (block 1)	50
4.3.3.3	Wholesale support costs (block 2)	51
4.3.3.4	Wholesale costs which do not have a causal relationship with products (block 3).....	51
4.3.3.5	Wholesale costs which have a causal relationship with products (block 4)	52
4.4	Allocation of the CUO (Customer operations) retail & non retail costs	54
4.4.1	Customer operations costs perimeter	54
4.4.2	Customer operations costs allocation principles.....	55
4.4.2.1	Introduction of 2 cost type attributes	55
4.4.2.2	Criteria for attribute dimension VAR_TYPE	55
4.4.2.3	Criteria for attribute dimension PS_TYPE.....	55
4.4.3	Customer operations costs allocation flows.....	56
4.4.3.1	Allocation of Organisational Group costs.....	56
4.4.3.2	Allocation of Outsourcing costs	57
4.5	Allocation of retail costs in the Life cycle of products	58
4.5.1	Cost perimeter	58
4.5.2	Allocation drivers	63

4.5.3	Modern equivalent opex (MEO).....	64
5	TEC OPEX (NETWORK&IT) STREAM	66
5.1	Allocation of TEC OPEX costs going through the “TECHNOLOGY” INCA module.....	66
5.1.1	Determination of the TEC cost perimeter.....	66
5.1.2	TEC cost allocation.....	67
5.1.2.1	Introduction of 2 cost type attributes	67
5.1.2.2	Criteria for Attribute dimension VAR_TYPE.....	67
5.1.2.3	Criteria for attribute dimension PS_TYPE.....	68
5.1.3	TEC allocation process	69
5.1.3.1	Allocation of “Organisational_Group” costs	69
5.1.3.1.1	Technology (TEC) Organisational group allocation	69
5.1.3.1.1.1	TEC network & IT OPEX organizational group allocation	69
5.1.3.2	Allocation of TEC support costs.....	70
5.1.3.3	Graphical view on TEC OPEX allocation flow.....	70
	Please note that the markets have been adapted as from the 2019 year model as follows :	70
5.2	Allocation of TEC OPEX costs not going through the “TEC” TCE module	72
5.2.1	GL61 accounts – Services and Other Goods (SOG).....	72
5.2.2	GL60 accounts – Material Out of Stock.....	72
6	IT STREAM.....	73
6.1	IT Allocation flow	73
6.1.1	IT allocation flow: Introduction	73
6.1.2	Data sources: IT Inventories and Reporting Systems:.....	74
6.1.3	Modules and Objects composing the IT allocation flow	74
6.1.4	IT Software and Hardware to Markets	81
7	NETWORK STREAM.....	82
7.1	A layered allocation model.....	83
7.2	From Assets to Network Stage Functions.	87
7.3	End User Services	92
	Copper Termination.....	94
7.4	Network services of the passive infrastructure layer : NLS1.0.....	94
7.4.1	Definition	94
7.4.2	Usage of the passive infrastructure	96
7.4.3	Contributors to the passive infrastructure layer	97
7.4.3.1	Access	97
7.4.3.2	Backbone	98
7.5	Network services of the transmission infrastructure (NLS2_o)	99
7.5.1	Definition	99

7.5.2	Usage of the transmission infrastructure	100
7.5.3	Contributors to the transmission infrastructure	102
7.5.3.1	Local Tail	102
7.5.3.2	Transport Segments.....	102
7.6	Network services of the packet based infrastructure (NLS2_1)	103
7.6.1	Definition	103
7.6.2	Usage of the data packet infrastructure	104
7.6.3	Contributors to the data packet infrastructure services.....	105
7.7	Network services of the mobile backhauling infrastructure (NLS 2.2)	108
7.7.1	Leased Lines infrastructure for mobile access backhauling	108
7.8	Network services of the IP infrastructure layer (NLS3-IP).....	109
7.8.1	Scope	109
7.8.1.1	Public services.....	109
7.8.1.1.1	IP_collection.....	109
7.8.1.1.2	Public_IP_switching	110
7.8.1.2	Private services	110
7.8.1.2.1	Private_IP&Ethernet_Extension	110
7.8.1.2.2	NLS3_Private_IP&Ethernet_Routing.....	111
7.8.1.3	Mobile Data traffic	112
7.8.2	Contributors to the Network Layer 3 services	112
7.9	Network Services of the application layer	115
7.9.1	Definition	115
7.9.2	Usage of the application layer	116
7.9.3	Contributors to the application services	120
8	ANNEX I: SCF FLOW ACRONYMS	125
9	ANNEX II: NETWORK AND IT FLOWS ACRONYMS	126

1 General description

REG (Group Regulatory Affairs) department sets up the Regulatory Cost accounting system, also referred as the cost model. In accordance with European Commission recommendations, the entire costs of statutory accounts are included in the cost model, to the exception of statutory accounts 65 to 68, as well as some other accounts excluded from the cost model perimeter. As said, the cost basis of the cost model is directly issued from the general accounting of Proximus SA, as recorded in SAP accounting tool. Statutory accounts 2021 of Proximus SA have been audited by Deloitte, external auditors. Deloitte auditors issued an unqualified opinion on statutory accounts.

The cost model allocates costs of Network/IT and SCF (Support and Customer flow), as included in the general accounting of Proximus SA, as well as the cost of capital of these two modules.

The following chart illustrates the Cost accounting system, as well as main allocation flows. The whole costs included in the allocation process are loaded in a tool (Telecom Costs Expert Software, referred as TCE) that runs accuracy tests and prevents double costs counting or multiple allocations.

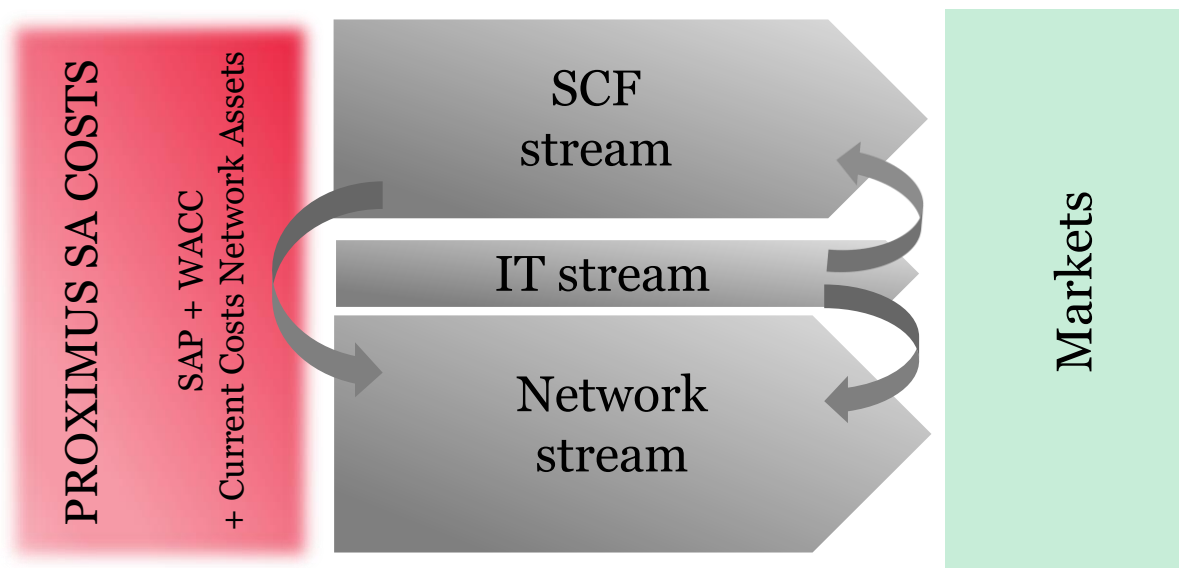

SCF allocation flows include costs that are of service to the customer and other direct and indirect costs that are not included in the Network nor IT allocation flows.

Network and IT flows include all the costs related to the Network and Information & Communication technology.

Costs allocated in allocations flows SCF, Network and IT have the same cost basis origin, this later being SAP statutory accounts of Proximus SA. IT tool TCE, in past models named INCA, makes

validity checks to prevent any double counting and trace allocated costs from their unique SAP cost basis origin to their final destination.

The Cost model per Market is a top-down model.

2 Model Allocation Structure

This section provides with a global view on the allocation structure of the model by walking through the major allocation flows and introducing the major building blocks and concepts in the model.

The following Figures will be the supporting tools for such discovery walk, where the major modules constituting the model as well as the global allocation flows among them are shown. The differentiation between SCF, Network and IT flows is also illustrated in the exhibit.

The overall objective of the model is allocating all the attributable costs present in the cost base to the markets as defined in the regulatory framework.

Therefore, the cost base constitutes the foundation of the model.

Further, the model allocation process is subdivided into three main streams, SCF, Network and IT.

The Cost base settings and the Non IT assets are presented in chapter 3.

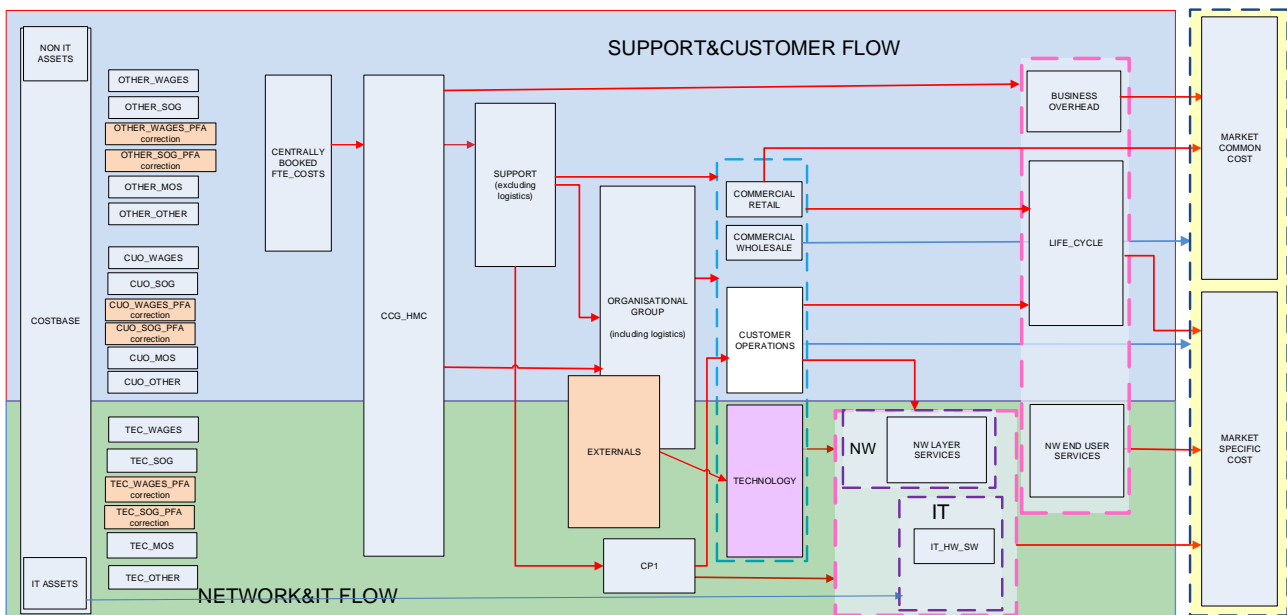

The SCF stream has as objective to allocate all costs that are not part of the Network or IT model towards the markets.

SCF stream (chapter 4) encompasses Staff & Support, Commercial Retail, Commercial Wholesale and Customer operations costs.

The IT and Network streams, although having completely separated CAPEX basis, both share a common OPEX source.

OPEX of IT and Network streams are handled via allocation of costs of Network business unit and Digital Transformation & IT business unit. Those 2 business units are gathered in the model in the Technology business unit (chapter 5).

WAGES OPEX allocation flows are as follows:

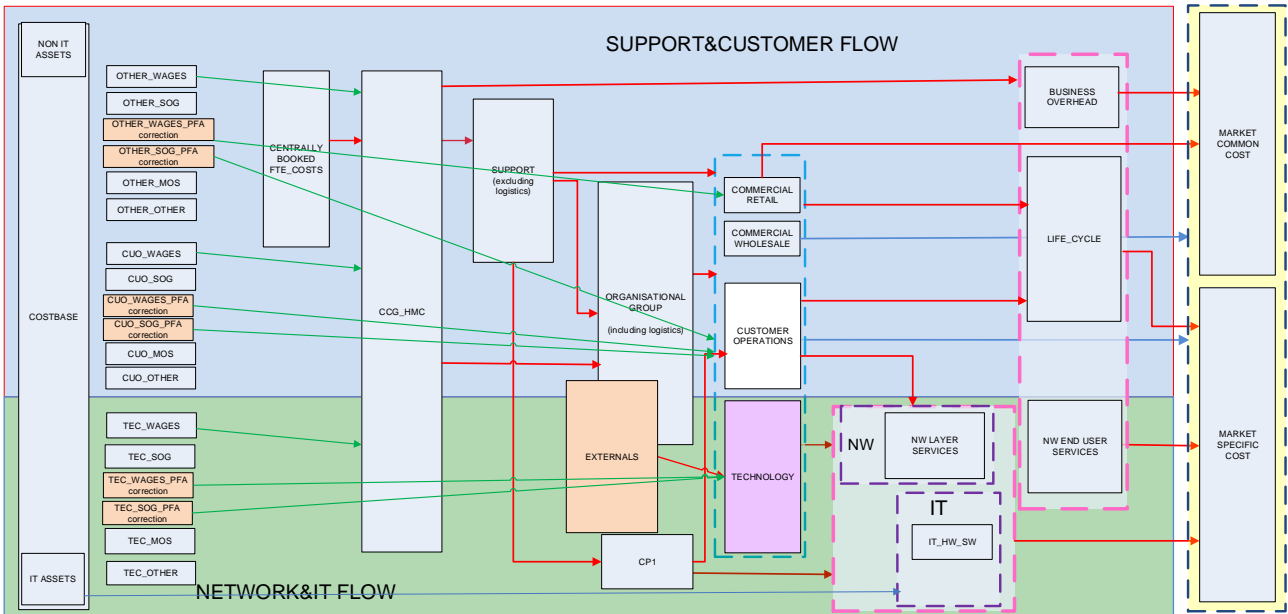

Services and Other Goods OPEX allocation flows are as follows:

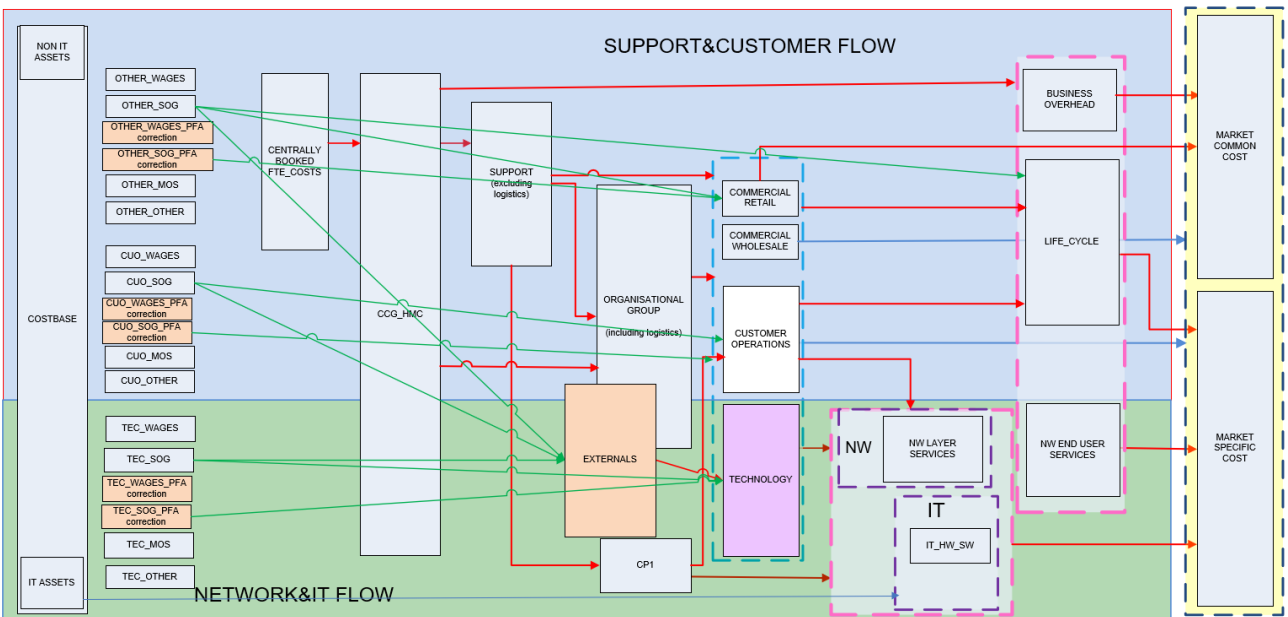

Materials out of stock and Other OPEX main allocation flows are as follows:

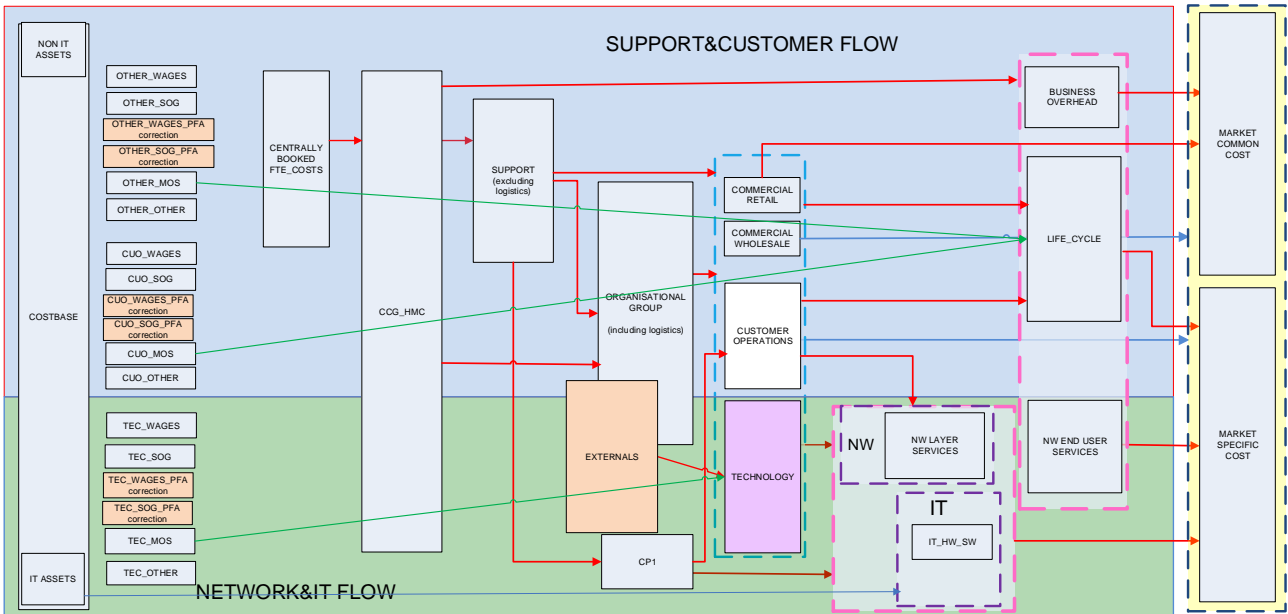

IT Assets allocation flows are as follows:

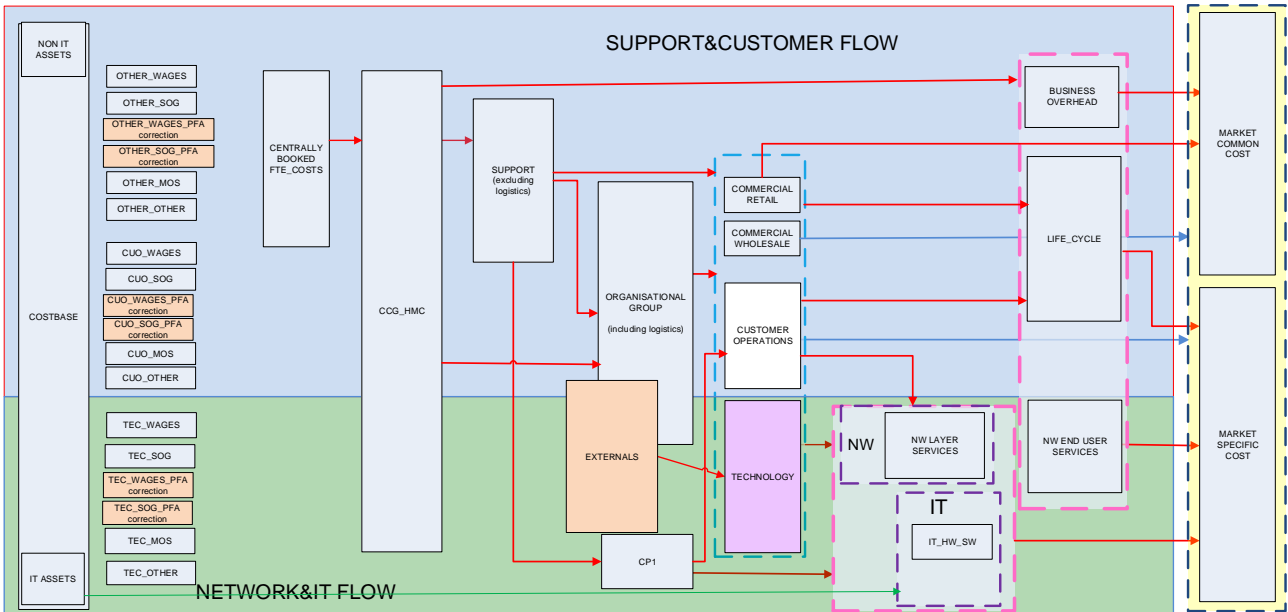

3 Cost Base

3.1 Cost model perimeter

3.1.1 Determination of the Cost model perimeter

Costs included in the Cost model are operating charges, i.e. general ledger (GL) accounts 60 to 64 of statutory accounting, as well as part of GL 69.

GL 60 “cost of goods sold” includes mainly telecom equipment purchases (modems, handsets, cables, mobile SIM cards, etc.), small equipment (cpe, ...) and stocks movements.

GL 61 « services and other goods » includes primarily costs linked to traffic (a.o. interconnection fees) and operating expenses such as maintenance, utilities, renting, marketing, representation allowances, consultancy, travel fees, etc.

GL 62 corresponds to all personnel costs (wages and other salary benefits).

GL 63 includes depreciation and amortization, stocks and trade receivable accruals for write-off and movements of provisions for liabilities.

GL 64 gathers other operating expenses, including a.o. write-off on trade receivables, immovable withholding tax and local taxes, taxes on pylons, etc.

GL 69 relates to company result appropriation corresponding to the part of personnel in the profit (collective bonus).

At last, GL 72 – « Produced Fixed assets » reduces the cost basis to cancel costs linked to produced fixed assets and to avoid a double counting of these costs with the corresponding depreciation charge.

To the costs perimeter from the general accounting is added the weighted average cost of capital (WACC) of 6,86% for Proximus traditional Fixed products, 8,45 % for Proximus FTTH products and 7,98 % for Proximus Mobile products.

3.1.2 Costs excluded from the Cost model perimeter

Other costs than those mentioned above are excluded from the Cost model. It relates to GL 65 to 69 of general accounting, to the exception mentioned above, for part of GL 69 (share of personnel in profit).

Some costs are excluded since considered as having no causal link to the products and activities. This matters for extraordinary costs (GL 66) and tax costs (GL 67 and 68).

Other costs are excluded since already included in the WACC. This relates to financial costs (GL65) and dividends appropriation (GL 69).

Costs excluded mentioned here above are costs excluded from the Cost model upstream (i.e., when defining Cost model perimeter with costs included in general accounting). On top of these ones,

other costs will be excluded downstream in the Cost model, i.e. costs excluded via the allocation flow. E.g.: Support costs involving affiliates.

3.2 Cost regrouping

Proximus books the costs on one hand, on a general ledger account defined in general accounting, and on another hand, on a cost center defined in reporting and analytics accounting. This way to handle costs has for objective to gather data, in order to simplify data processing.

Two types of aggregation are done in the Cost accounting model:

- Aggregation of 658 GL of general accounting in 154 Cost pools (CP)
- Aggregation of 575 cost centers in 166 Cost Centers Groups (CCG).

A **Cost pool** is a group of costs with similar characteristics and issued from the same family of cost natures.

Regarding material resources, gathering of costs is based on the similar function that these costs have. E.g., cost pool “Training expenses” sums up costs of trainings organized inside Proximus, external trainings, training books and documentation costs.

Regarding human resources (referred as FTE, or Full Time Equivalent), cost pools gather workers with the same profile. E.g., cost pool “Level S” includes wages and salaries of employees with level S (Sales force), as well as premiums and other wages benefits paid to these employees.

Costs included in the same cost pool have an identical causal link to the products and activities to which they related. They have the same “resource driver”.

A **Cost Center Group (CCG)** sums up cost centers with similar characteristics and realizing similar activities and as a consequence, can be aggregated into the same cost center group.

Each Cost Center Group uses various cost pools.

Combinations cost pool/cost center group constitute the **Resource Groups**. The Resource Groups are the Cost basis of the Cost model.

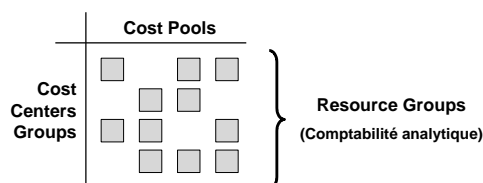

3.3 Organization

The organizational structure of Proximus SA, as on December 31, 2021 as used in the Cost base, is as follows:

Part Consumer/Residential, Enterprise Business Units and Customer Operations



Part Network, Digital & IT, Carrier Wholesale and Staff & Support

- This organisation has a clear split between the residential and professional customers by the divisions Consumer and Enterprise Business units, as well as the wholesale customers with Carrier & Wholesale Business unit,
- The Technology Business unit in the model (referred as TEC) brings together Network and Digital & IT Business units,
- The Customer Operations Business unit gathers all services in direct link with the customer, whether residential consumer or enterprise or wholesale,
- Staff & Support Business unit includes activities of Staff such as Finance, Human Resources, Strategic planning, Group Corporate Affairs (including Legal, Group Public Affairs, Regulatory, Internal audit, Group communications and Secretary General Legal), as well as Support activities. Support activities encompasses internal services like Fleet, Catering, Real estate, Corporate Prevention & Protection (buildings and employees), etc.

Cost perimeter is split by the REG department between allocation flows of Network/IT and Support and Customer flow, after completeness and accuracy checks (no double counting) on costs data from SAP. As mentioned in general description, allocation flow Network/IT allocates all costs and assets (capital expenditure) in IT and Network, while the allocation flow Support and Customer flow allocates costs and assets other than IT and Network related.

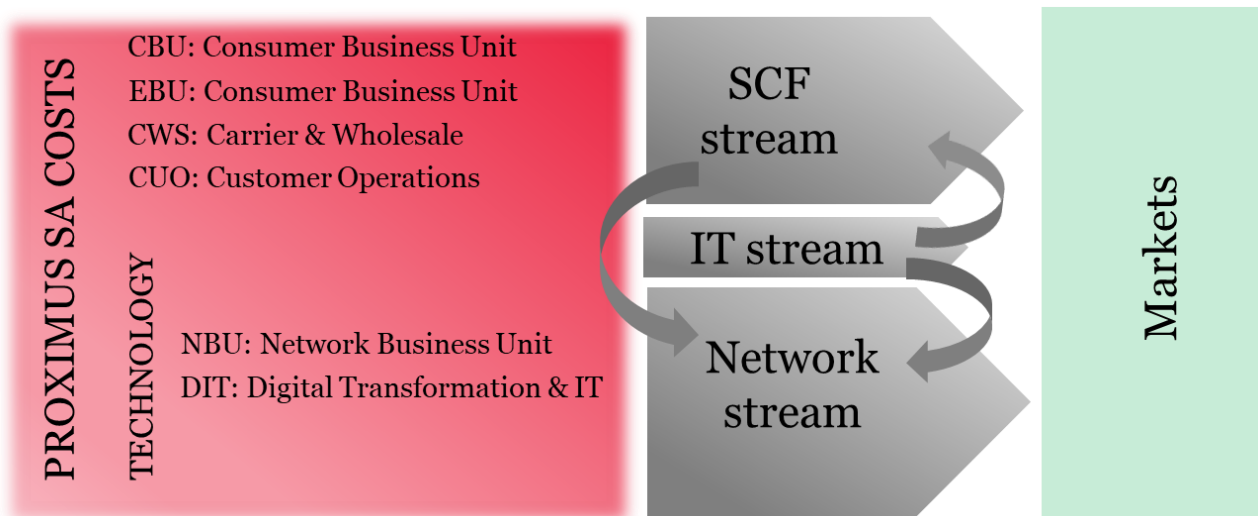

Split of cost perimeter between allocation flows Network/IT and SCF is processed as follows:

- All departments within TEC are treated within the Network / IT flow.
- Provisions for taxes on telecom equipment that are booked at the level of TEC management are downstream shared via allocation flows between assets classes to which they relate.
- All the other costs not mentioned above are treated within the SCF flow namely the divisions CBU (Consumer Business Unit), EBU (Enterprise Business Unit), CWS (Carrier Wholesale), CUO (Customer operations) and Staff & Support. The Staff & Support division comprises different departments, including Executive committee, GCA (Group Corporate Affairs) which includes Legal, Group Public Affairs, Regulatory, Internal audit, Group communications and Secretary General, Finance, Group Human Resources, Group Strategy & Transformation and Support internal services ensured by departments like Real Estate, Energy management, Infrastructure & Facilities management, Corporate Prevention & Protection, Fleet and Catering.
- Regarding Assets (depreciation and WACC), repartition is done based on an analysis of assets classes: assets IT and Network are handled in the allocation flow Network/IT, while all other assets (buildings, utilities equipment, CPE, etc.) are allocated in the flow SCF.

3.4 Assets revaluation

3.4.1 Decision tree

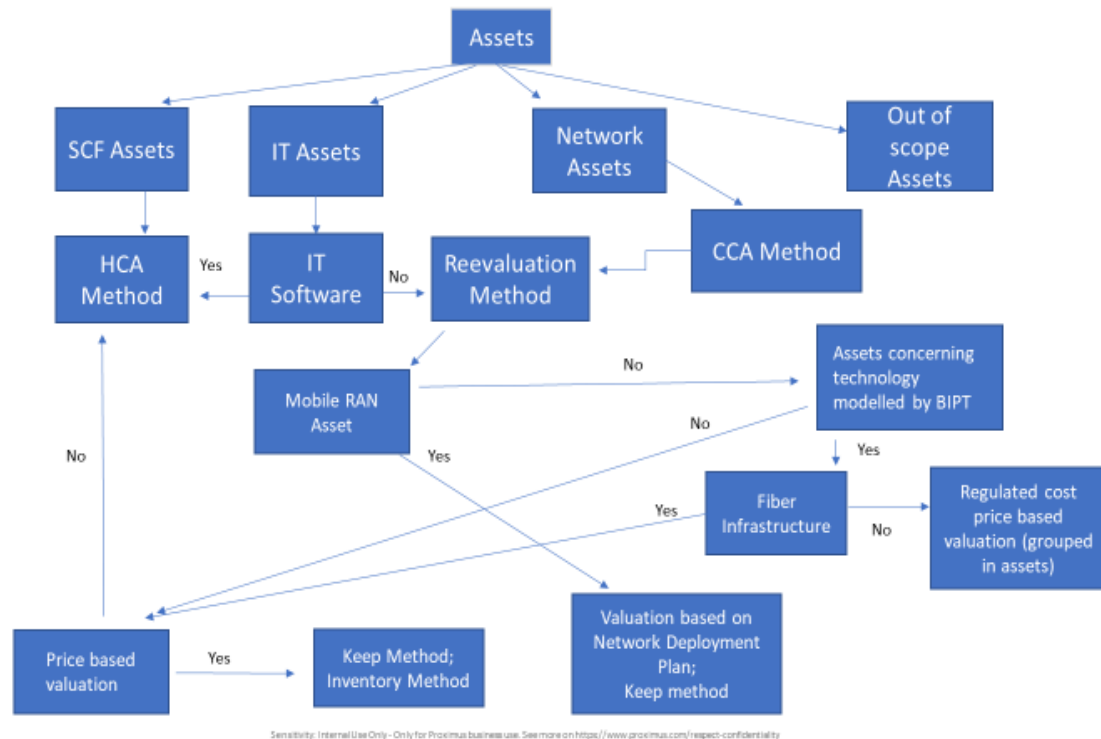

3.4.1.1 *Split network - SCF and IT assets*

The assets base was split up in Network – SCF and IT assets. The cost of the network assets must be based, for operators being declared as dominant, on the Current Cost Accounting. For the SCF assets (EBU-CBU– CUSTOMER OPERATIONS- SUPPORT-Facilities-Sourcing-Fleet) and IT software related assets the cost accounting systems is based on the Historical Cost Accounting method.

3.4.2 Methods used to reevaluate the network assets

The regulatory framework clearly states that the cost accounting systems of operators being declared as dominant on relevant markets must be set based on Current cost accounting for the network costs.

The network & IT flows within the top down model calculate the current costs for the network related assets. Current costs have been computed as explained hereafter.

There are three methods to evaluate the current value of the network: reassessment of the current inventory, by default “keep everything as it is” and regulated cost price based. For mobile radio access networks assets, the valuation is based on the forecasted expenses of Proximus for the active radio equipment in the joint venture. Each of these methods requires its own set of inputs. It is mainly the availability (or lack) of input which dictates the choice of the method. Nevertheless, each method has its advantages and disadvantages with respect to the others.

The inventory method assumes that network departments replace the equipment of its assets by equivalent equipment. The notion of equivalent is quite fuzzy. An engineer would tell you that over time there are always more functions integrated in new equipment and that they are always more cost-effective. It makes the comparison between different generations of equipment difficult. The notion of equivalent has therefore been addressed through the term Modern Equivalent Asset (MEA). The assets must be replaced by their MEA. The MEA is the replacement cost of the technology expected to be in place within the planning horizon. Note that this notion takes into account the introduction speed of a new technology in the network. If network departments plan to have replaced 50% of an old technology by a new one within the planning horizon, it makes no sense to simulate the costs with higher percentages because the planning takes into account the availability of the resources to carry out the work.

Find hereafter the rules that have been used:

- ❑ Technology still in procurement: use current price, e.g. IP equipment
- ❑ Technology to be replaced within the planning horizon: use current price of the modern equivalent asset, e.g. TDM based voice equipment are replaced by IP based voice equipment.
- ❑ Technology grouped in : those assets will be revaluated by another asset concerning the same technology
- ❑ Old technology not anymore in service : those assets are set out of scope and will not be revaluated
- ❑ Old assets revaluated by keep method will keep the CAV value as GRC
- ❑ BIPT regulated technology : use the BIPT models to extract relevant unit costs or use BIPT bottom-up models to directly calculate CAPEX costs with 2020 demand volumes

3.4.2.1 ***Inventory***

This is the best method to reflect accurately the price of assets currently in service in the network. The revaluation is merely performed by multiplying the volume of each specific type of equipment currently deployed in the network by its average current unit cost. The current unit costs are based on the prices defined in the current frame agreements we have with our suppliers.

In terms of inputs it is the most demanding method. It requires an extensive inventory of equipment.

3.4.2.2 ***Keep as it is.***

The “keep as it is” method is merely what its name says. We keep the price we have in the historical accounting books. This method is only valid for costs with a very short depreciation period or for software intensive products. For the latter we assume that on the one hand software development is labour intensive but on the other hand the rapidly evolving programming environment improves the productivity compensating for the higher labour cost. This results in a stable software price. Another practical reason to select the “Keep as it is” method is the amount booked on the asset. If this amount is small, the method has also been applied. In this particular case, the effort to collect all the information about the cost evolution outweighs the impact on the service costs.

3.4.2.3 ***Asset valuation based on BIPT bottom-up cost models***

The market for fixed telecommunication services, the related technologies and the competition have evolved through the years leading to the current situation where the vast majority of the telecom services provided by the Proximus’s access and area backbone networks are regulated. This regulation has been enforced, amongst other initiatives, by clearly specifying the services and applying regulated tariffs, as reflected in the Proximus Reference Offers (BRUO, BROBA, BROTSOLL, BROTSOLL Ethernet and WBA).

Since the regulated tariffs are cost oriented and determined by bottom-up costing models, it is reasonable to re-use these models to calculate the required CAPEX based on current demand.

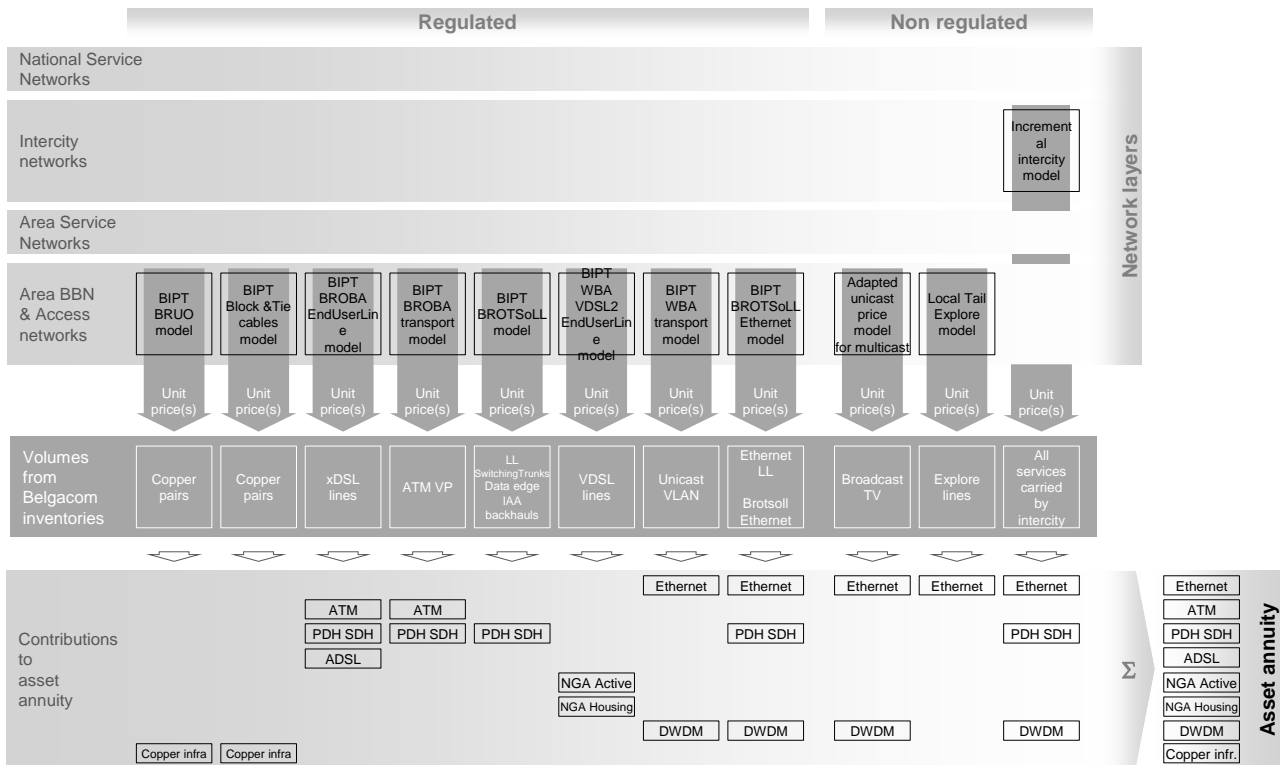

Figure 1: BRxx based valuation method. Scope and implementation.

3.4.3 TAM: Tilted Annuity Method

3.4.3.1 Theory

The purpose of this section is to describe how the Tilted Annuity Method (TAM) is finally implemented in the Current Cost Accounting (CCA) based network cost model.

As from the 2003 model, Proximus implemented the formula that BIPT suggested.

$$ACC_{\mu Y} = F1, \mu Y \times F2, \mu Y$$

where

$$F1, \mu Y = (GRC_{\mu Y, \text{begin}} + GRC_{\mu Y, \text{end}}) / 2$$

$$F2, \mu Y = \sqrt{(1 + WACCY) \times [1 - (1 + APC_{\mu}) / (1 + WACCY)]} / [1 - [(1 + APC_{\mu}) / (1 + WACCY)]^{L_{\mu}}]$$

and where

- $ACC_{\mu Y}$: Annual CAPEX Cost of asset μ and year Y . It includes the annual depreciation and the cost of capital.
- $WACC_Y$: WACC of year Y .
- $GRC_{\mu Y, \text{begin}}$: Gross Replacement Cost of asset μ at the beginning of year Y .
- $GRC_{\mu Y, \text{end}}$: Gross Replacement Cost of asset μ at the end of year Y .
- APC_{μ} : Annual Price Change of asset μ .
- L_{μ} : Lifetime of asset μ .

Remarks:

The formula assumes that:

- In the beginning of year Y was invested in an asset and that at the middle of each year of the lifetime of the asset revenues will be generated.
- The annual price change is constant over the lifetime of the asset.
- The asset price does not evolve during the year, i.e. price changes only appear at January 1st.

The factor $F1, \mu Y$ represents the value of asset μ in the middle of year Y .

- The purpose of the arithmetic average of $GRC_{\mu Y, \text{begin}}$ and $GRC_{\mu Y, \text{end}}$ is to take into account investments or disinvestments of asset μ during the year Y .
- The arithmetic average of $GRC_{\mu Y, \text{begin}}$ and $GRC_{\mu Y, \text{end}}$ does not filter out the price evolution of the asset μ during the year Y .

The difference between the formula of BIPT and the formula of Exhibit 5, p. B3. of the white paper of Analysys is the factor $1 / \sqrt{1 + APC_{\mu}}$, which filters out the price evolution of the asset μ during the year Y .

The gross replacement cost (GRC) of assets at any particular point in time is calculated as the sum over all assets owned by the business at that point in time, of the investment that would be necessary to purchase and install new replacements for those assets at that point in time (using modern equivalent assets if the existing assets are no longer available or efficient). The replacement value of assets, used for costing purposes should always include the gross value of every asset in use by the business (the current cost of replacing it with a new, possibly modern equivalent asset), irrespective of the history of depreciation of that asset in any financial accounts to date.

L_{μ} : Lifetime of asset μ , i.e. the expected useful lifetime of the new asset μ .

The depreciation period and the expected useful lifetime of a new asset are defined differently. The depreciation period refers to accounting. The expected useful lifetime of a new asset does not refer to accounting. It refers to the period that is expected that a new asset will be used. The main factor to determine the expected useful lifetime of a new asset is the evolution of the associated operational costs, i.e. the asset will be replaced when operating it becomes too expensive. Another factor is the appearance of new technology: if in the future new technology will come-up it could be that the asset will be replaced (even if it is not too expensive to operate).

4 SCF (Support and Customer Flow) stream

4.1 Allocation of the support costs

4.1.1 Support Scope

Since 2013, all support costs are treated within one SUPPORT module and as such, no cascade principle is used meaning that support costs, once in the SUPPORT module, can only be allocated to a non-support destination and to a non-support division. The divisions that are considered as support costs are:

- Group Internal Services (GIS – BA34) for departments like Real Estate, Business Services, Security, Safety & Environment, and Catering.
- Supply Chain Management responsible for warehousing, logistics and distribution is now part of the CUO division.
- Infrastructure Facility Management (IFM – BA78) encompasses a wide variety of support activities like building & technical services, print shops and copy shops, energy and operational centre of excellence.
- Fleet Management (FLT – BA79) for the support of all Proximus management, utility and sales vehicles.

They fall under the responsibility of FIN, the financial department from the Staff and Support division (S&S – BA20) where are located the GHR, Legal, Strategy, Public Affairs and Communications departments. The Staff & Support costs should avoid passing by the Support allocation flow as they are business overhead related costs. There can be some exceptions to this rule when a specific support cost is booked in the BA20 such as illustrated below:

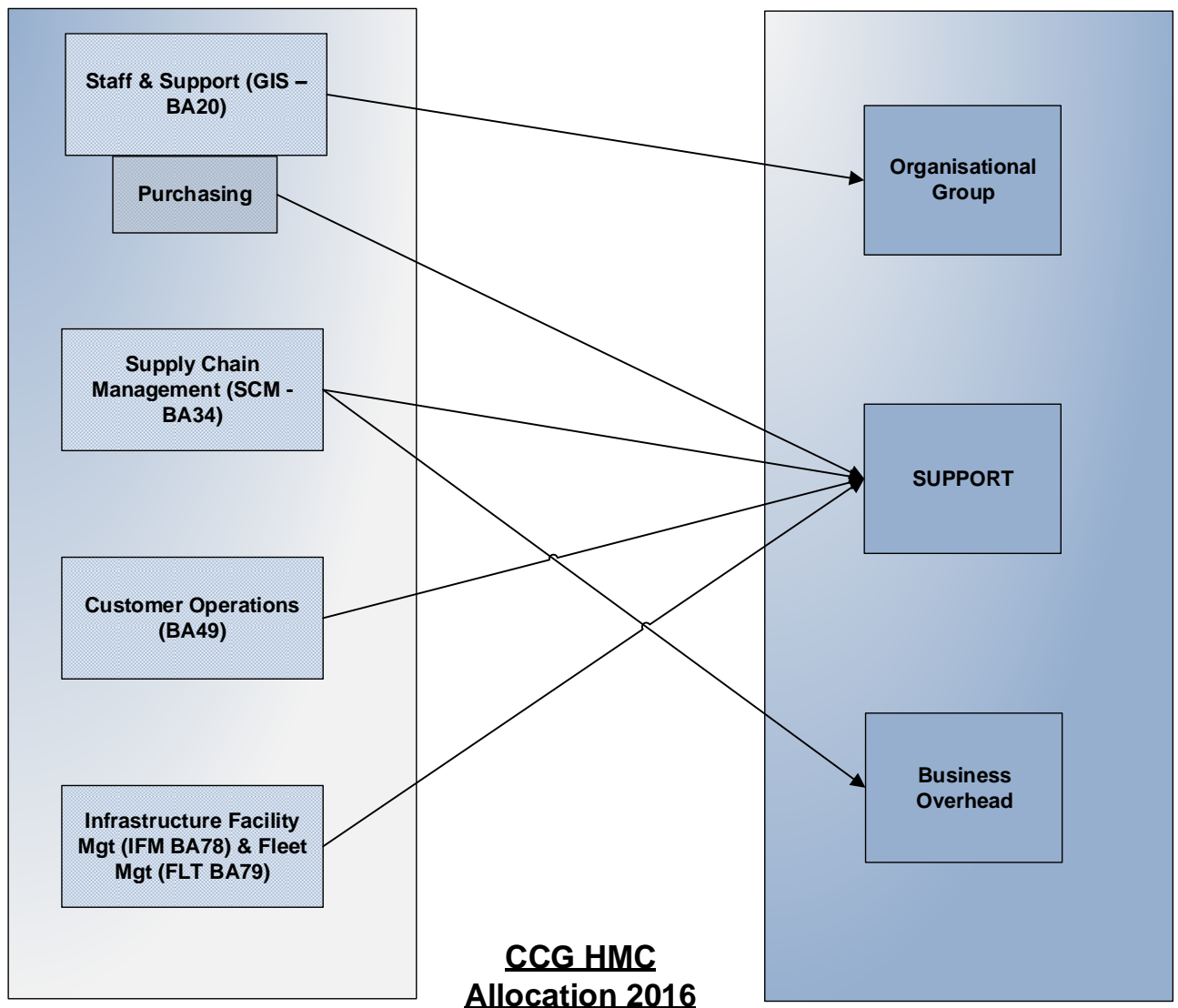

4.1.2 Support Cost Objects

The following support objects were created in order to pool support-related costs within one module, before allocating them either directly to the cost's specific object located further on in the cost model, either to multiple objects using inventory-based allocation keys. This work is achieved by using reports from dedicated teams supporting an inventory from which specific volumes can be derived, such as the ones from fleet management regarding Proximus vehicle's park or Connect Immo regarding the building's occupation. A last group of support objects are allocated by the use of FTE keys in order to split these costs among all departments that benefit from them. The overall support allocation can be summarized as follows:

Summary of Driver type relation to Support Object allocation

Avg # FTE ALL LEVELS with office excl. support/centrally booked

- Support_Manage moves
- Support_Manage waste and scrap
- Support_Manage, maintain and repair buildings (excluding moves) (office space)

Support_Provide catering services

Support_Provide copy services

costs of shops buildings (in %)

Support_Manage, maintain and repair buildings (excluding moves) (shop space)

Direct

CBU_billing_fix products

CWS_Billing

EBU_billing_fix products

MOB_billing

Support_13001 Data Managed Services & Applications

Support_14001 TV and VoD

Support_22243 Nat. IC - infra. Co-location /Co-mingling

Support_30000 Subsidiaries & externals

Support_IT

Support_Power Chain for ROP

Support_Power Chain for telecom_SDE

Support_PROX_Pylons

Support_Telecom space_SDE

Estimated Nbr Management Cars

Support_Manage, maintain and repair fleet vehicles (management vehicles)

Estimated Nbr of Sales Cars

Support_Manage, maintain and repair fleet vehicles (sales vehicles)

Estimated Nbr of Utility Cars

Support_Manage, maintain and repair fleet vehicles (utility vehicles)

Stock Material return

SUPPORT_Reverse_Logistics

Stock Quantities

Support_Manage goods, warehouse & equivalentents

Sum of Purchase Orders

Support_Purchasing, quality and ordering

total MOS value 2011

Support_Manage cables

Value of material transported from stock (in eur)

Support_Manage internal distribution

The driver named “Avg # FTE All Levels with office excl. support/centrally booked” is a specific driver calculated internally by the cost modelling team. It excludes from its scope all support divisions and teams that do not benefit from these costs such as employees not occupying a desk in Proximus Buildings. This is done in order to match the scope of these costs. In order to give coherence to such trade-off, the decision factor for the Customer Operation division was changed from the level of the employee within the company to the cost variability of the organisational group in question. The underlying reason being that fixed costs organisational groups are management

related while variable ones are field related. Therefore, only fixed organisational groups were considered in the scope of this driver as the field teams are by definition not in Proximus offices and should not benefit from the specific support costs this key is applied to.

It should be noted that training costs related to Proximus’s Corporate University (PCU) have to avoid passing through the SUPPORT module but have to be pooled with their respective team’s/CCGs. The grouping of these costs is done as illustrated below:

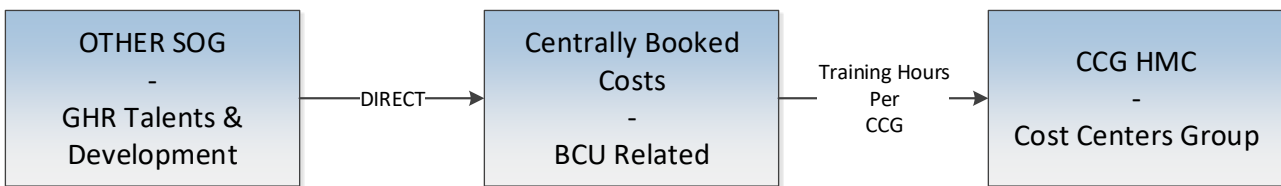

In 2015, Logistics and warehouse activities were reorganized within the CUO division in order to improve the quality of service by giving more consistency to the customer service chain as well as improving the systems of logistics controls in order to better the material flow in the Proximus group. The warehouse is where most equipment used by Proximus or by its clients are stored. Allocation keys are based on the inventories from their corresponding team registering which type of equipment in what type of quantities were stored and delivered.

4.1.3 Asset Support Allocation

Two types of assets allocations can be distinguished: The ones that can be directly linked to a support object from the previous list and allocated as shown by the following diagram:

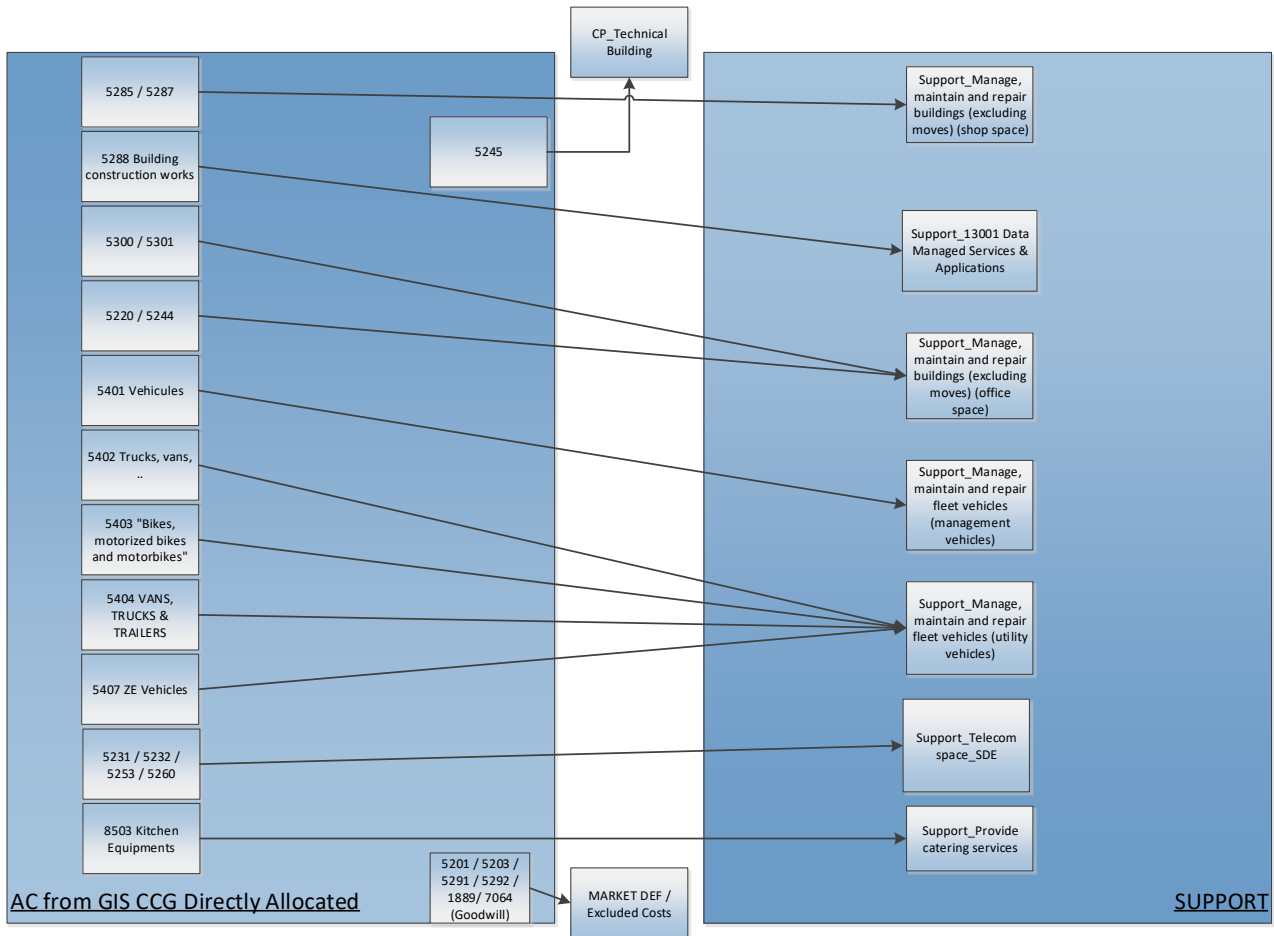

Other assets affect multiple support activities where the use of a specific cost driver is required. Typically, buildings, fleet and energy are support activities that need to be ventilated on many support objects with the use of their corresponding driver: vehicles per category for fleet, square meters occupied per building type for buildings and electricity consumption per equipment or building for energy. The following diagram represents the logic behind asset allocation towards the support flow by presenting its main allocation drivers:

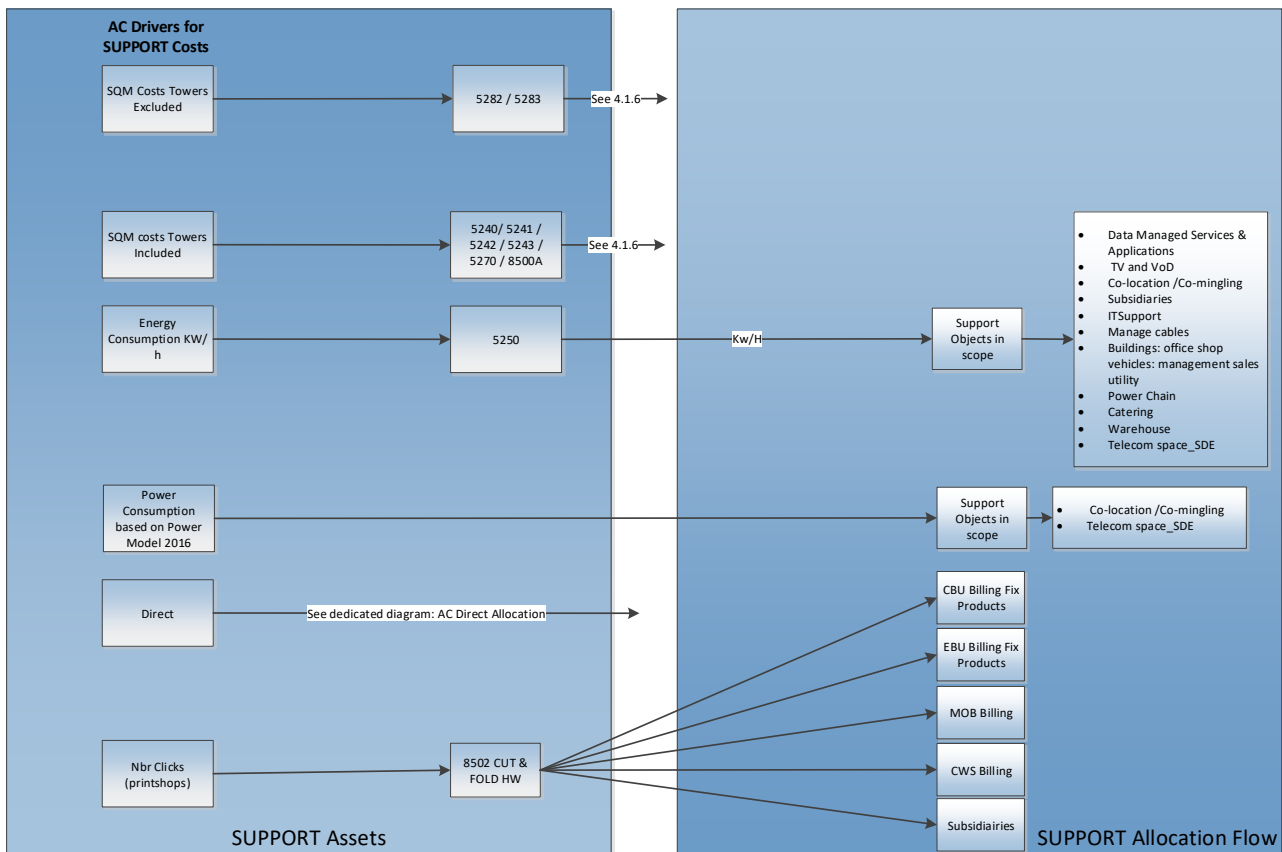

4.1.4 Allocation From the support module

The same principle as before is applied: if a support object can be directly linked to an object located further on in the cost model, it will be directly allocated to it. Such cases are illustrated in the following drawing:

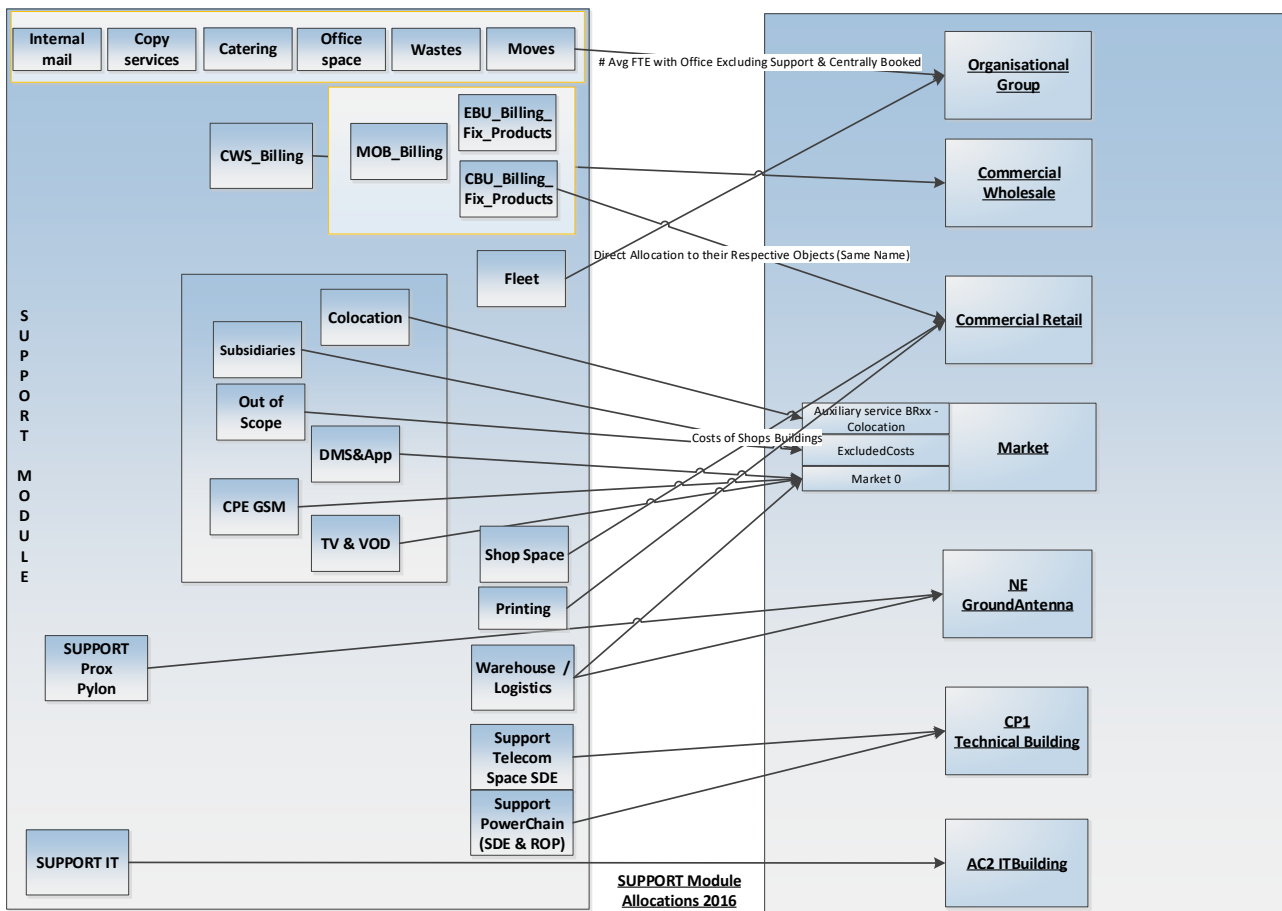

4.1.5 Fleet case

All fleet related costs are pooled in the Support module within the three following objects:

- The support, maintenance and repair of management vehicles.
- The support, maintenance and repair of sales vehicles
- The support, maintenance and repair of Utility vehicles.

With the use of an inventory maintained internally by Proximus, the number of vehicles per type and organisational group is used as an allocation key for the fleet costs.

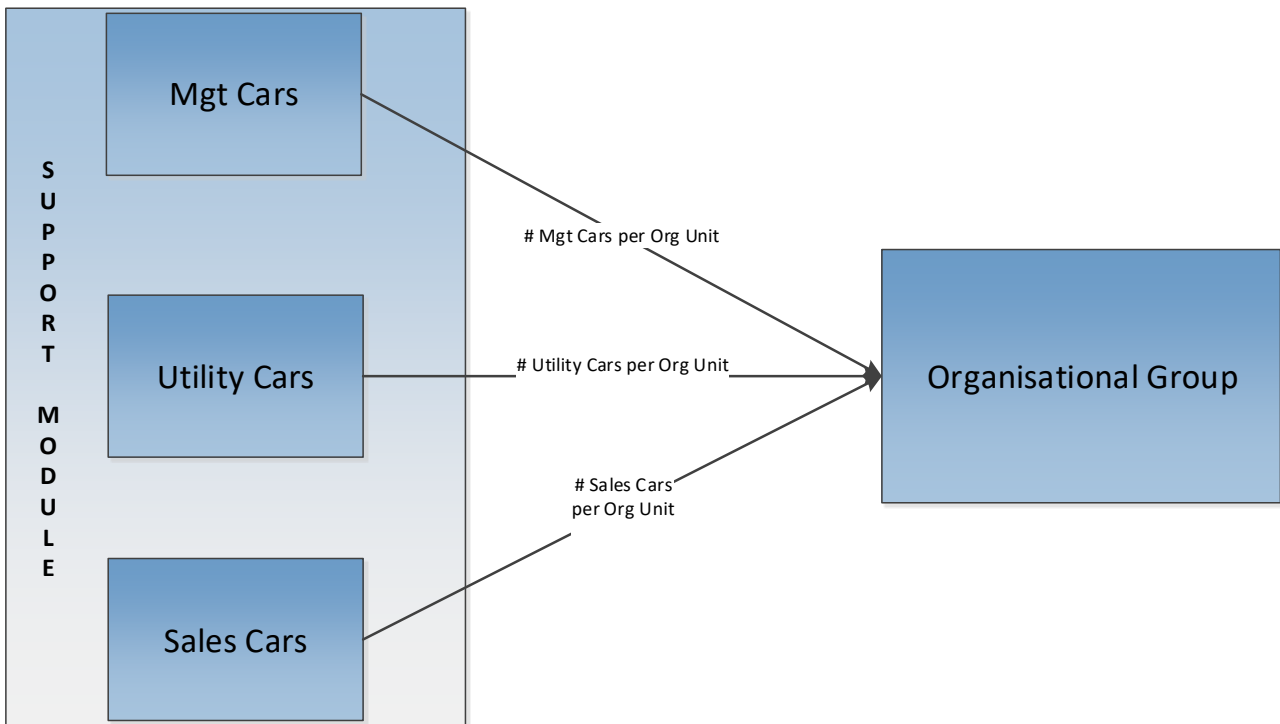

4.1.6 Buildings Support costs :

4.1.6.1 Global picture of the allocation:

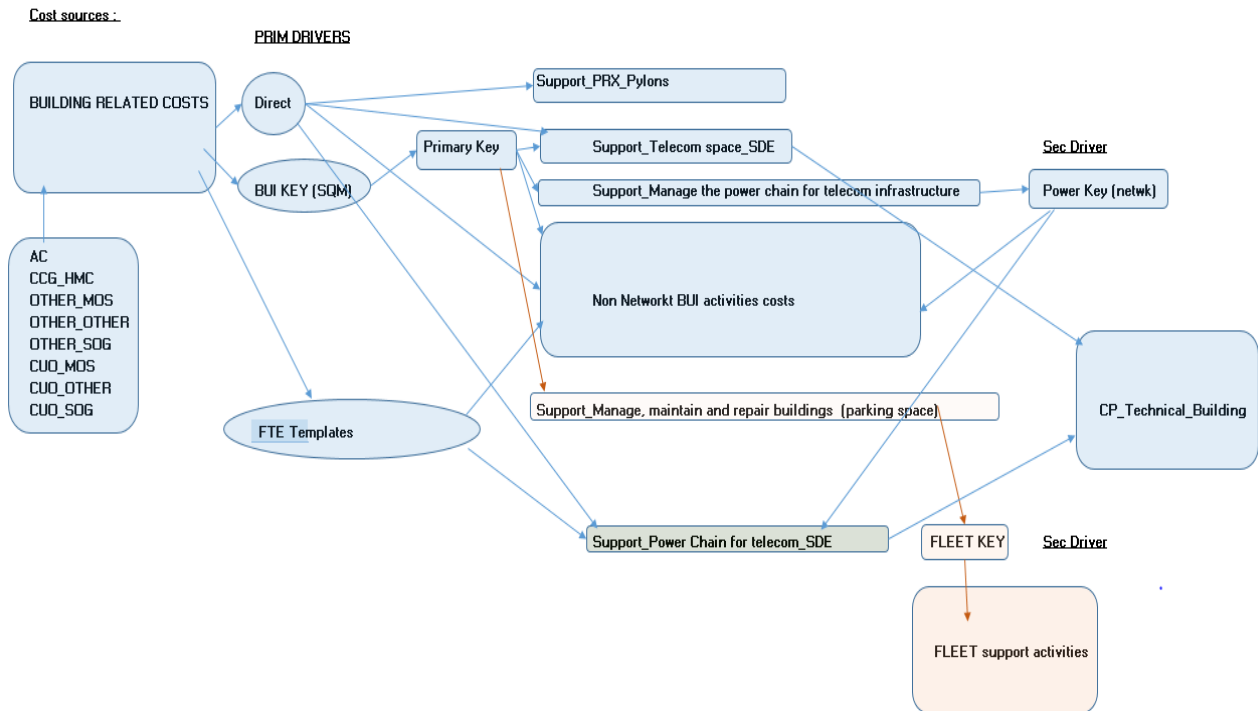

4.1.6.2 Source of the buildings costs :

The BUI support costs are mainly coming from :

COST NATURE	Source of costs
ASSET	5255 Heating, Ventilation & Air-Conditioning
	5220 Exploitation land
	5240 Exploitation buildings
	5282 Work in rented building
WAGES	78401 GIS - IFM - BTS-Building & Technical Services
	34300 GIS - CPP - Securit - Safety & Environment
	78003 GIS - ASP - PRO - Projects
OTHER_OTHER	GIS - IMM - Real Estate / 34100 / tax-building / 6401
	GIS - IMM - Real Estate / 34100 / local taxes / 6407
OTHER_SOG	GIS - IMM - Real Estate / 34100 / building / 61010
	GIS - ENY - Utilities & Support / 78610 / Pylons / 61195
	GIS - CPP - Securit - Safety & Environment / 34300 / building / 61010
	GIS - IFM - BTS-Building & Technical Services / 78401 / building / 61010
	GIS - ENY - Utilities & Support / 78610 / energy / 61060
	GIS - IMM - Real Estate / 34100 / Clmmo & third party building & equipm. taxes / 61160
	GIS - MOB - IFM - OTH - PYLONS / 78501 / building / 61010
	GIS - MOB - IFM - OTH - PYLONS / 78501 / energy / 61060

4.1.6.3 Drivers used for the allocation

4.1.6.3.1 The SQM (Tower included or excluded).

This key is based on a database provided by ConnectImmo, the Proximus separate entity that manages the PXS Building/SQM portfolios. Volumes (sqm) are valued by category (office, telecom, parking, catering,...) and the resulting keys are used to allocate the costs.

SQM Allocation

sources and process

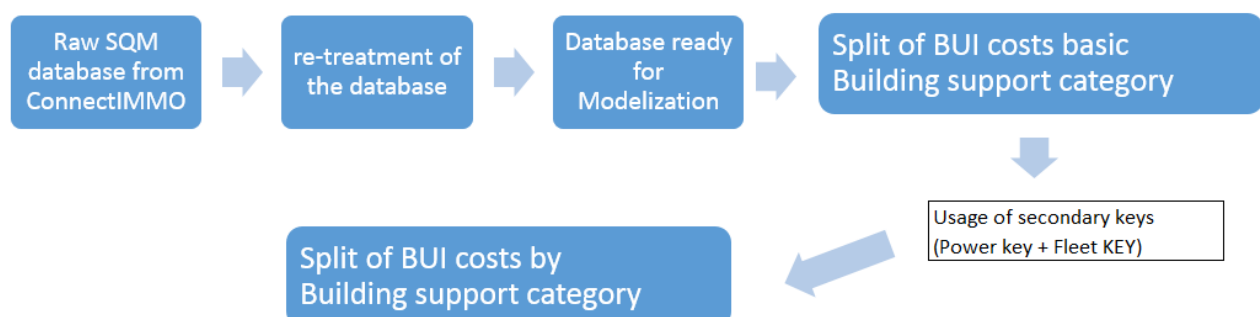

4.1.6.3.2 Direct:

Pylon related costs, Exploitation land (AC) to Support_Manage, maintain and repair buildings (excluding moves) (office space)

4.1.6.3.3 FTE Template completion

The following teams are allocated with the input of team leaders (split of FTE's by Building activities). These teams are in charge of the management of the Proximus Buildings.

- 78001 GIS - ASP - PRO - Coordination
- 78003 GIS - ASP - PRO - Projects
- 78400 GIS - IFM - Infrastr. & Fac. Mgt & Support Staff
- 78401 GIS - IFM - BTS-Building & Technical Services

4.1.6.4 The Destination of the BUI related costs :

After usage of primary and/or secondary keys, the BUI related costs are allocated to following activities:

Activity	
Support_Telecom space_SDE	Network related
Support_Power Chain for telecom_SDE	Network related
Support_PROX_Pylons	Network related
Support_Manage cables	Network related
Support_Manage, maintain and repair buildings (excluding moves) (shop space)	Retail related
Support_Manage, maintain and repair fleet vehicles (utility vehicles)	Fleet related (Parking space)
Support_Manage, maintain and repair fleet vehicles (management vehicles)	Fleet related (Parking space)
Support_Manage, maintain and repair fleet vehicles (sales vehicles)	Fleet related (Parking space)
Support_Manage, maintain and repair buildings (excluding moves) (office space)	FTE related
Support_Provide catering services	FTE related
Support_IT	IT related
Support_Manage goods, warehouse & equivalents	Logistics related
Support_14001 TV and VoD	product related
Support_13001 Data Managed Services & Applications	product related
Support_30000 Subsidiaries & externals	product related

4.1.7 The power Key:

This key split the power related costs coming directly from power costs and from the buildings to different costs objects. It is based on the analytical split provided by the field:

The total KWH consumption is known is split in 4 categories:

1. Mobile access (directly allocated to Support_PROX_Pylons)
2. Fixed access network (indirect allocation) to:
 - Support_14001 TV and VoD
 - Support_22243 Nat. IC - infra. Co-location /Co-mingling
 - Support_30000 Subsidiaries & externals (for memory)
 - Data centers, (split between SUPPORT_IT an Support_13001 Data Managed Services & Applications, based on real consumption)
 - Support_Power Chain for telecom_SDE
 - Support_Power Chain for ROP
3. Shops
4. Other (directly allocated to shops, or allocated to various element via generic key : offices, ...)

4.1.8 Allocation of the Network building related costs : CP_Technical_Buildings

Based on the ConnectIMMO database (SQM), ITR (equipment), and some measurement and constants (footprint of equipments), the CP_Technical_Building is allocated via the running of an access macro.

4.1.8.1 Allocation Flow :

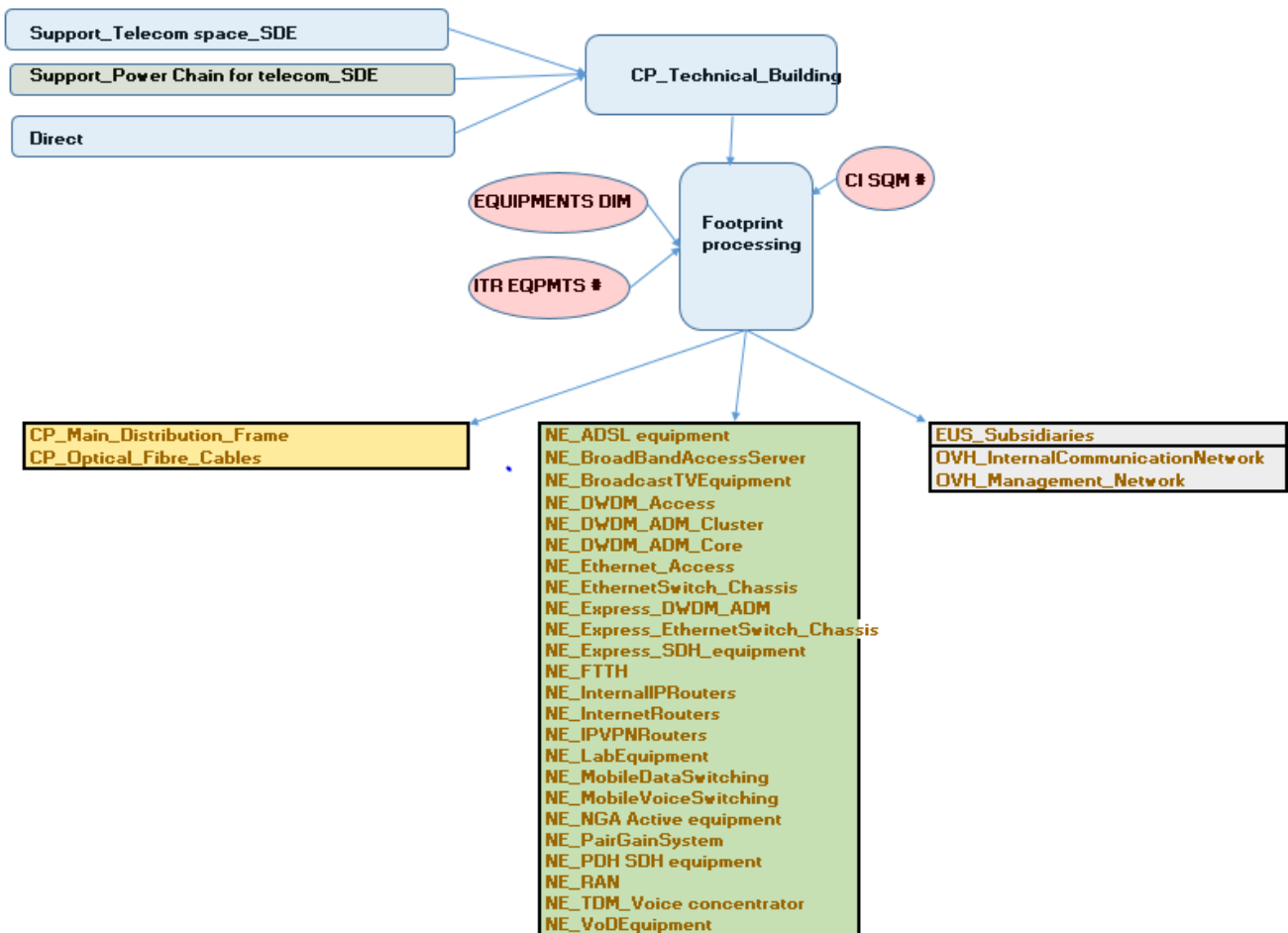

4.2 Allocation of the retail costs of the Consumer and Enterprise Business units

4.2.1 Retail costs perimeter

As stated previously the Proximus organisational structure distinguishes between 5 distinct organisational pillars that are recapitulated in the Cost model as follows:

- Consumer Business Unit (CBU) has the responsibility over the residential customers and small enterprises (less than 10 employees)
- Enterprise Business Unit (EBU) has the responsibility over the professional customers
- Customer Operations (CUO) has the responsibility to deliver services to customers such as provisioning, after sale and repair
- Technology (TEC) centralises Network and IT services
- Staff and support (S&S) groups all horizontal functions sustaining the Group activities

In this chapter, we deal with the Retail costs related to the commercial activities at the level of Business units CBU and EBU. There other Retail costs of the Cost model, that refer to services delivered to the final client, whether on client site or on remote, for installation or repair of the service, are dealt in the following chapter 4.4. related to Customer operations Business unit.

The Proximus financial and accounting structure clearly registers retail costs on cost centers 39xxx (CBU) or cost center 41xxx (EBU).

Starting from the Proximus organisational structure, we can identify 4 blocks in the Retail cost perimeter:

1. Retail FTE related costs
2. Retail Support costs
3. Retail costs that are not FTE related, nor Support costs, which do not have a direct causal relationship with products
4. Retail costs that are not FTE related, nor Support costs, which have a direct causal relationship with products.

Definitions and examples

1. Retail FTE related costs

Includes all direct FTE related costs of Business units 39 and 41 (GL 62, wages and other salary benefits) and indirect FTE related costs (some GL 61, as travel & representation costs, social benefits such as catering costs, etc.).

Includes also some costs that are not directly attributed to Retail Business units in the accounting books but do relate to Retail FTE activities. This concerns costs which are centrally booked and/or managed but which need to be flagged towards all Proximus FTE's. E.g.: costs re. Fleet, office building, train cards, bonus, training, gsm's in the context of the employee phone program

...

Retail Support costs

Retail Support costs are non FTE related costs which are centrally booked and managed but relate to Retail activities. E.g. Billing, Shop space...

2. Retail costs that are not FTE related, nor Support costs, which do not have a direct causal relationship with products

This block includes costs such as IT developments not capitalized for applications specific to Retail departments, costs for legal claims, mandatory professional contributions, market surveys, etc.

3. Retail costs that are not FTE related, nor Support costs, which have a direct causal relationship with products

Costs that have an identifiable causal relationship to the products. E.g.: Cost of sales such as commissions paid on sales of identifiable products, cost of goods sold on equipment, dedicated outsourcing costs, etc.

4.2.2 Retail costs allocation principles

4.2.2.1 *Introduction of 2 cost type attributes*

Two cost type attributes are introduced in the cost model.

These attributes are "VAR_TYPE" and "PS_TYPE".

4.2.2.2 *Criteria for attribute dimension VAR_TYPE*

Dimension VAR_TYPE qualifies Retail costs based on their variability towards product volumes.

We distinguish between 4 var_types:

- a. Marginal (mar): retail costs which can be considered variable with each additional unit of a single product. Typically, it concerns costs of goods sold (e.g. handsets, customer premises equipment...) and costs of sales (commissions, interconnection costs...).
- b. Variable (var): retail costs which can be considered sensitive to (important) volume changes of a single product or a range of products, whereby this (range of) product(s) is considered as the last increment in the product portfolio. Examples of costs which are considered variable based on these criteria: the sales departments, call center activities....
- c. Fix (fix): retail costs are considered as fixed when they are likely to be inert to important volume variances. E.g.: Marketing spending. If the marketing campaigns can be directed to specific products, the amount of costs for these campaigns is not linked to volumes of the considered product.
- d. Common (common): retail costs are considered common when they do relate to the ordinary course of business but have no relation with

products. E.g.: Costs of litigations, branding & sponsoring expenses not directed to specific products, but well to Proximus image and trademark...

4.2.2.3 **Criteria for attribute dimension PS_TYPE**

Dimension PS_TYPE qualifies retail costs based on whether they can be attributed directly, or through a specific non generic key and/or driver, towards products.

We distinguish between 2 PS types:

- a. PRODUCT SPECIFIC (PS): these costs can be allocated directly to the products and thus are generated specifically for that related product. E.g. the costs of sale of a product.
- b. NON PRODUCT SPECIFIC (NPS): Retail costs which do not have a clear causal relation with specific product.

In addition to the attribute PS_TYPE, all retail costs of RETAIL module are flagged with an additional dimension "COST GROUP" enabling to identify the (span of) product(s) it covers.

COST GROUP specifies the product, when the cost is product specific.
COST GROUP also gives the information on whether the costs are related to both Retail Business Units (CBU and EBU) or are only linked to one of them.

Used Cost Groups for the Retail costs are:

Non product specific

All CBU&EBU products
ALL CBU&EBU mobile products
All CBU products
All EBU products
All CBU Fix products
All CBU Mass market products
All EBU Fix products
All EBU professional & Mass market products
All EBU Telco products
All EBU, CWS, SE products

Product specific

All CBU Mobile products
All EBU Mobile products
All EBU Advanced Telco Services products (*)
All EBU Fix data products
All EBU Fix voice products
All EBU ICT products
idTV
(*) m2m&IOT, Big data, Mobile Payment&Ticketing

The qualification of the 2 attributes VAR_TYPE and PS_TYPE to all retail costs is illustrated in the following decision tree:

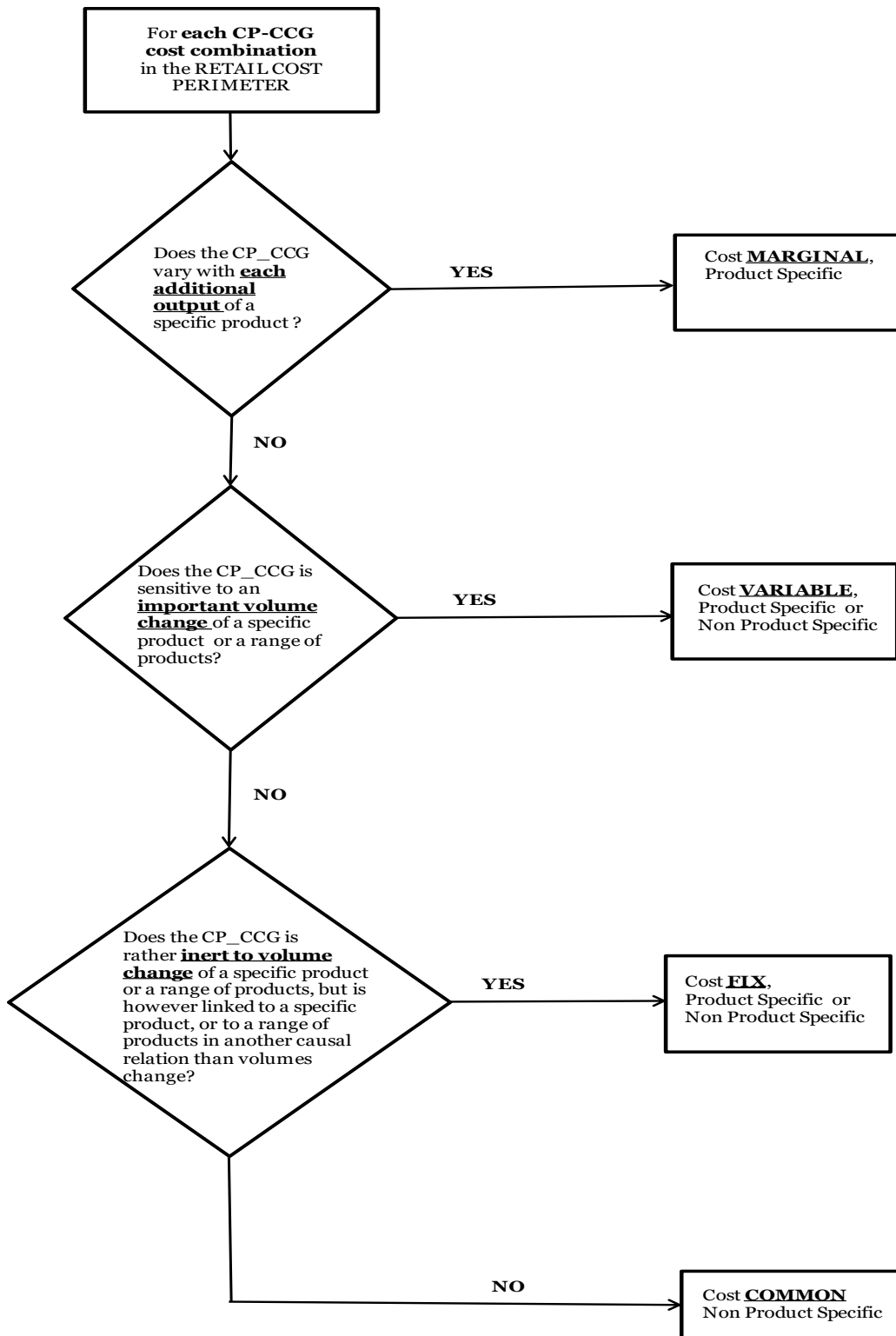

4.2.2.4 ***Allocation of retail costs to Markets***

All Retail costs belong to unregulated Market. The allocation is direct towards this Market.

To enrich the Cost model allocation with information on segmentation of the costs, the allocation of Retail costs split them between the *Consumers and Small Enterprises Costs* market and the *Corporate and Medium Enterprises Costs* market.

Some Retail costs transit via the Module Life_cycle, prior their allocation to the Market. The objects of the Life_cycle module are enriched in their definition with a product complexity factor, used as a basis for determining unit costs of products. See following chapters 4.2.3. Retail costs allocation flows and 4.5. Allocation of Costs included in the Life Cycle of products.

4.2.3 Retail costs allocation flows

4.2.3.1 ***General principles***

As described above, the 4 blocks of costs included in the Retail cost perimeter are all specified with 2 cost type attributes (VAR_TYPE; PS_TYPE) prior to be allocated to Markets.

However, the 4 blocks of costs:

- Do not follow all the same path of allocation; some are directly allocated to Markets from the Cost basis,
- Are not all specified with VAR_TYPE and PS_TYPE within the module Retail.

The allocation flow followed by a Retail CCG_CP will depend on its block of costs (1->4).

Life cycle of products

Since the Cost model 2014, a new module, the LIFE_CYCLE module, was created, to catch part of the Retail costs that we find during the life cycle of a product.

Inside the 4 categories of Retail costs, as described in chapter 4.2.1., all the costs needed to launch, develop, monitor a product until its improvement/phase out, were identified and gathered in this new module, prior to be allocated to Markets.

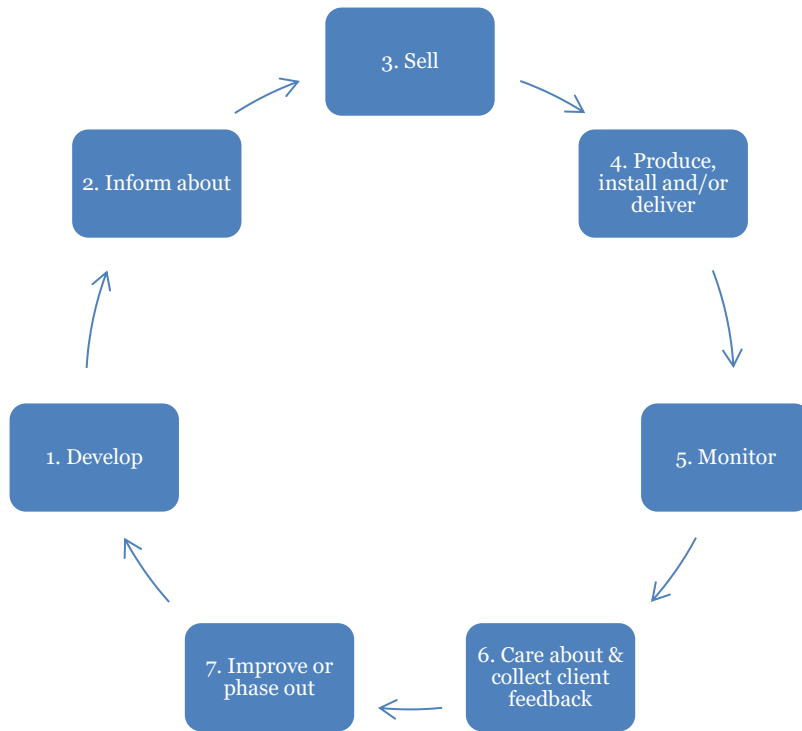

4.2.3.2 ***Retail FTE related costs (block 1)***

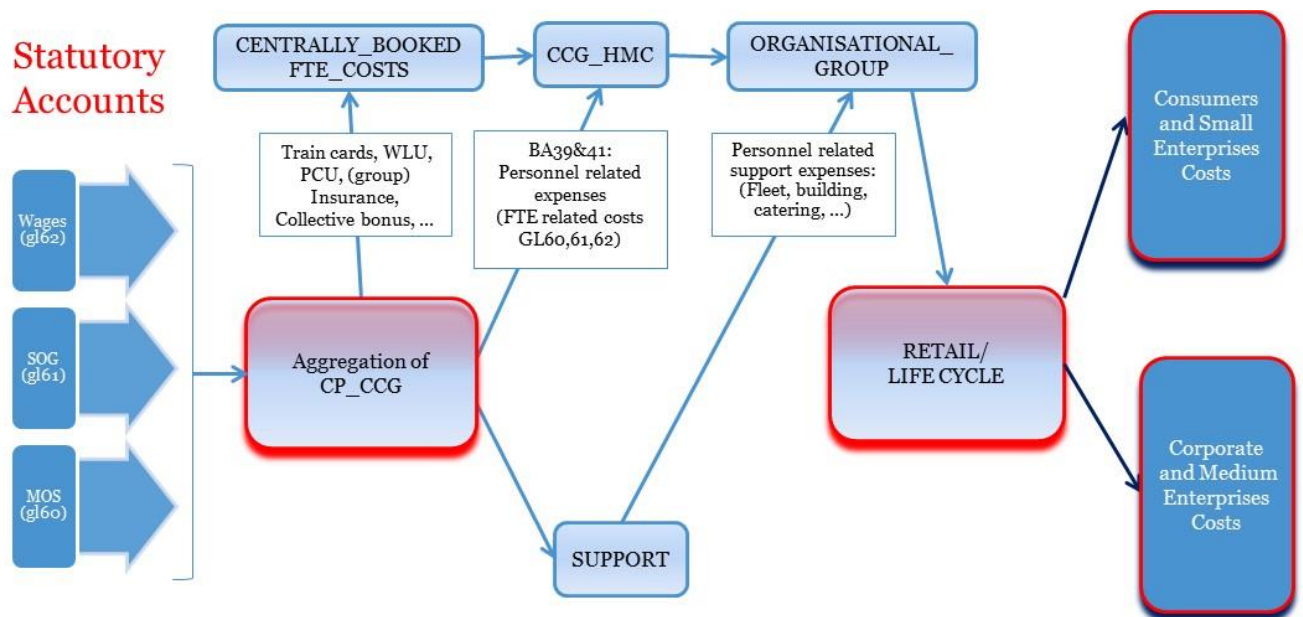

CP = costpool = a grouping of G/L accounts/costs which have similar characteristics and reside under the same nature of costs.
 CCG = cost center grouping = grouping of cost centers with comparable characteristics.

Starting from the Cost basis, Retail FTE related costs are at first gathered into module CCG_HMC. CCG_HMC module is simultaneously feeded with module Centrally Booked FTE costs (Train cards, WorkLifeUnit costs, etc.).

Retail FTE related costs gathered in CCG_HMC are afterwards loaded into module ORGANISATIONAL_GROUP. In ORGANISATIONAL_GROUP module, FTE related costs are summed up with SUPPORT costs managed centrally (Fleet, building, catering, etc.) but that must be allocated towards Proximus FTE costs.

This is also at this stage of allocation flow that attributes VAR_TYPE and where CCG_CP are renamed as “Organisational groups” (terminology specific to FTE costs).

Organisational groups costs are at last directed to module Retail, prior to be allocated to Markets (via LIFE_CYCLE module, for part of it).

With regard to the definitions of attribute dimension VAR, Retail FTE related costs can only be either Fix (FIX), either Variable (VAR) costs.

For what matters FTE costs, this variability sensibility has been defined taking the following assumption:

Are Fix FTE costs, all the FTE costs that are needed to ensure the Proximus going concern independently of products volumes, id est, costs needed to maintain the Proximus minimum organizational structure.

Two types of FTE costs were identified as needed to maintain the Proximus minimum organizational structure:

- Staff costs such as IT officers supporting DB and IT tools used, reporting and analyst teams, research staff such as Products&Solutions engineers, Marketing staff costs;
- All the Proximus hierarchy structure (team responsible).

The classification of FTE costs for CBU and EBU between FIX and VAR costs, and whether product_specific or not, is as follows:

CBU Organisational group	FIX/VAR	PS/NPS	Cost Group
Top management	Fix	NPS	All CBU products
Sales - Top management	Fix	NPS	All CBU products
Direct sales & e-sales	Var (*)	NPS	All CBU products
Support staff for Sales department (all channels)	Fix	NPS	All CBU products
Marketing	Fix	NPS	All CBU products
Call Center Activities	Var	NPS	All CBU products
idTV Content management	Fix	PS	idTV
Products & Solutions management	Fix	NPS	All CBU products
Strategy & Business development	Fix	NPS	All CBU products

(*) excluding Team responsible flagged as Fix costs.

EBU Organisational group	FIX/VAR	PS/NPS	Cost Group
Top management	Fix	NPS	All EBU products
Strategy and business development	Fix	NPS	All EBU products
Marketing	Fix	NPS	All EBU products
COR (1) Top management	Fix	NPS	All EBU products
COR Direct sales	Var (*)	NPS	All EBU products
In charge Relations for COR clients	Fix	NPS	All EBU products
COR ICT Services & Outsourcing	Fix	PS	All EBU ICT products
Project management & Business integration	Var (*)	NPS	All EBU products
Business design, delivery and Operations	Var (*)	PS	All EBU ICT products
ME (2) top management	Fix	NPS	All EBU products
ME Direct sales	Var (*)	NPS	All EBU products
Support staff for ME Sales (all channels)	Fix	NPS	All EBU products
In charge Relations for ME indirect sales channels	Mix Fix/Var	NPS	All EBU products
Telco & ICT Solutions Top management	Fix	NPS	All EBU products
Telco & ICT Solutions Specialists and Solutions sales	Mix Fix/Var	NPS	All EBU products
Financial reporting & IT Tools management	Fix	NPS	All EBU products
Services & Pricing	Fix	NPS	All EBU products

(*) excluding Team responsible flagged as Fix costs.

(1) COR, for CORPORATE, is the subdivision of EBU including big size enterprises.

(2) ME, for Medium Enterprises, is the subdivision of EBU including smaller size enterprises (from 10 to 50 employees).

Some EBU organisational groups have a mix of Fix/Var costs per type of activity. The scission of these teams into FIX and VAR costs is based on #FTE, in accordance with Proximus functional organization and Retail principles for determining if a cost is FIX or VAR.

E.g.:

Teams in charge for relations with indirect sales channels are made of Direct sales (VAR costs) and of people in charge of Sales channels optimization, strategy and budgeting (FIX costs).

Teams of Solutions Specialists and Solutions Sales are made of Direct sales (VAR costs) and Products&Solutions managers in charge of product catalogue and architecture (FIX costs).

Retail FTE Var costs are allocated towards activities in the LIFE_CYCLE module, prior to be sent to Market(s). We refer to chapter 4.5 Allocation of Costs included in the Life cycle of products, for further developments on allocations of Retail FTE VAR costs.

4.2.3.3 ***Retail Support costs (block 2)***

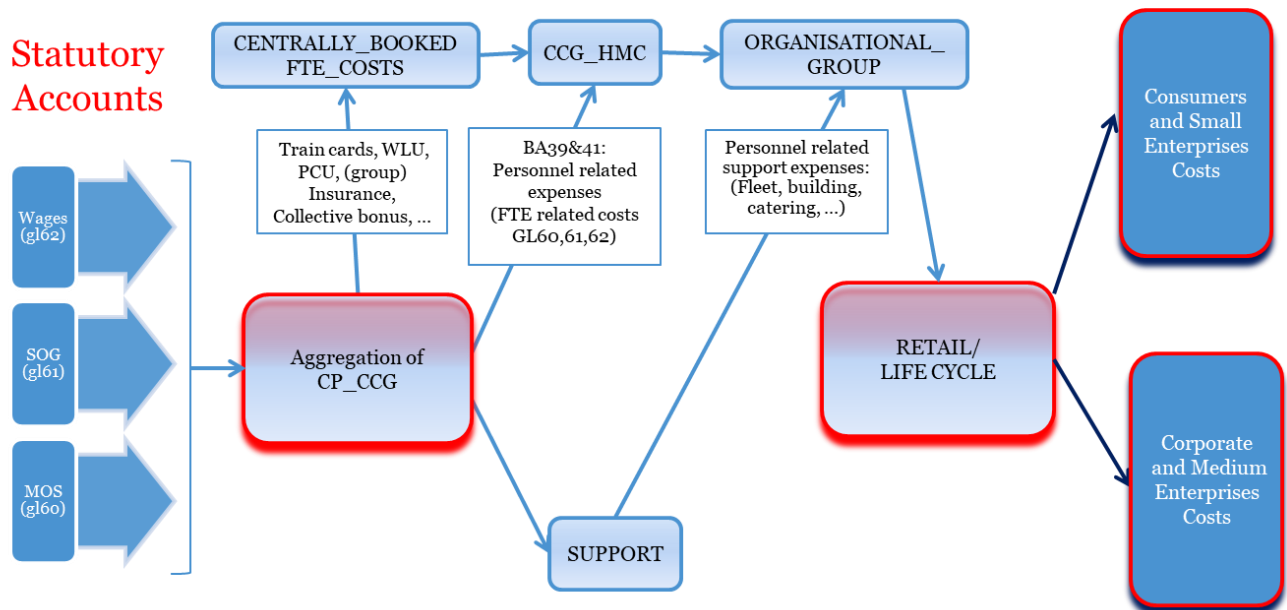

CP = costpool = a grouping of G/L accounts/costs which have similar characteristics and reside under the same nature of costs.
 CCG = cost center grouping = grouping of cost centers with comparable characteristics.

Module SUPPORT identifies and collects the costs of some support objects which a.o. are retail related.

The retail related support objects primarily concern billing costs (invoice printing, stuffing and postage, as well as teams in charge of billing&collecting) and costs for shop space. These costs are primarily gathered in module SUPPORT.

Costs for shop space are considered fix. The costs of creation and maintain a shop is not linked to the volumes of products the shop offers, but well to other criteria such as geographical localisation, local withholding tax regulation, points of sales optimization, etc. The CBU shops sell all types of products. These costs are therefore assigned as non product specific.

Since 2019, Proximus shops are fully occupied by Proximus Direct Sales. Costs for shop space are accordingly allocated towards those teams, via module RETAIL.

Billing costs are fix, non product specific costs.

4.2.3.4 Retail costs which do not have a causal relationship with products (block 3)

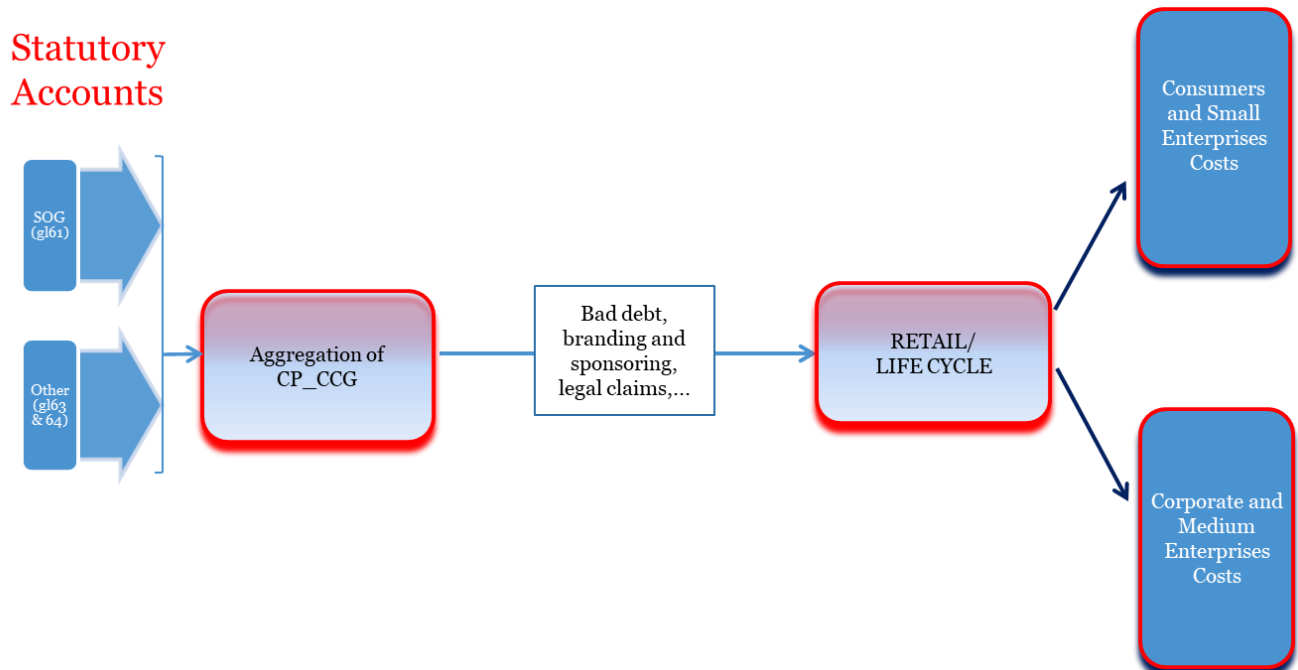

Per definition these costs are either fix (e.g. IT developments not capitalized for the internal needs of a Retail department, bad debt, etc.) or common (e.g: branding and sponsoring costs, Corporate Social Responsibility enterprise costs, legal claims, etc.).

Per definition, these costs are non product specific.

Most of costs of block 3 are sent to module Retail, where linked to the activity of a Retail organisational group, prior to be routed to the (segmented) Market .

Bad debt is categorized as fix costs. Bad debt does not have a link to products but well to criteria such as competitive environment, regulatory framework (telecom laws), quality rating of the portfolio of clients, rather than to volumes of products.

Follow up and provision for bad debt is not done per products, but well per invoices and clients. Bad debt tends to increase with turnover growth.

4.2.3.5 **Retail costs which have a causal relationship with products (block 4)**

Statutory Accounts

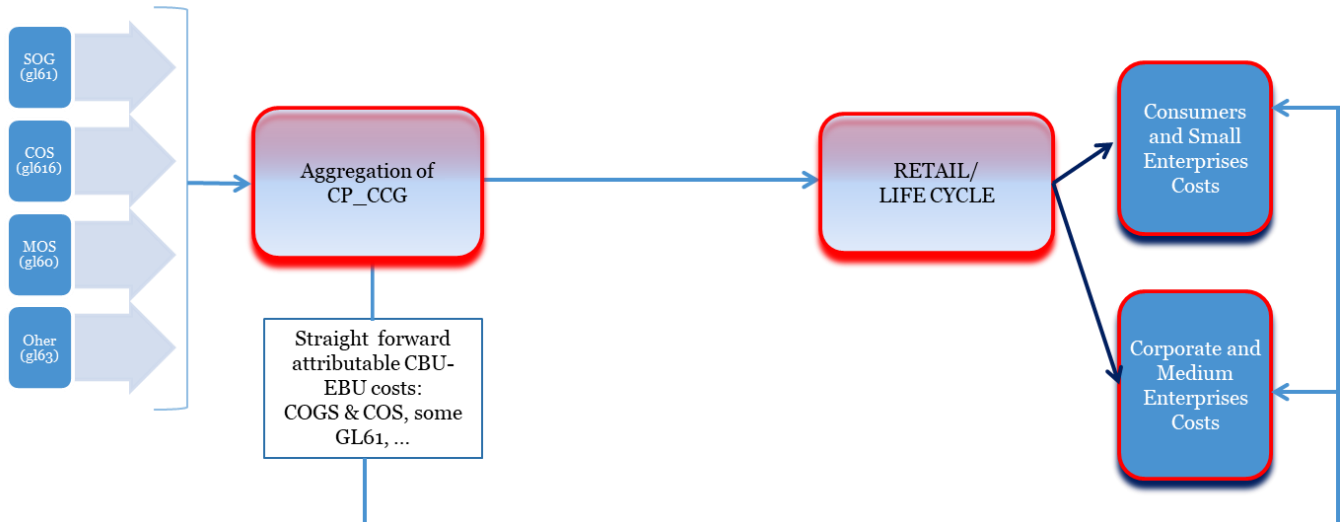

Are included in this block of Retail costs, all the costs that are not FTE related costs, nor Support costs, that have a causal relationship with products.

Examples of costs of this category are Cost of goods sold, costs of sales (e.g: commissions indirect sales channels, interconnection fees), campaigns marketing directed on a product, and sales actions oriented on a dedicated products such as Outbound call sales actions..

Most of the costs of block 4 are gathered by similar categories into Retail and/or LIFE CYCLE modules, prior to be allocated to the Market they relate, some of them being however directly sent to the Market they relate.

Per definition, Retail costs of Block 4 have a causal link to products. The causal link to products can be volumes driven (MAR, VAR costs) or not.

Are therefore included the following combinations of VAR_TYPE; PS_TYPE:

VAR_TYPE	PS_TYPE	
	Product_specific	Non_Product_specific
Marginal	x	-
Variable	x	x
Fix	x	x

Cost of goods sold and Cost of sales have a direct link to product they relate. Therefore, they can be allocated directly.

Marketing expenses are per definition fix non_product_specific costs. Part of Marketing expenses can however be allocated to (specific) product(s) (Markets), in case of dedicated campaigns.

Retail allocation flows – all costs blocks (1->4), can be illustrated as follows:

Statutory Accounts

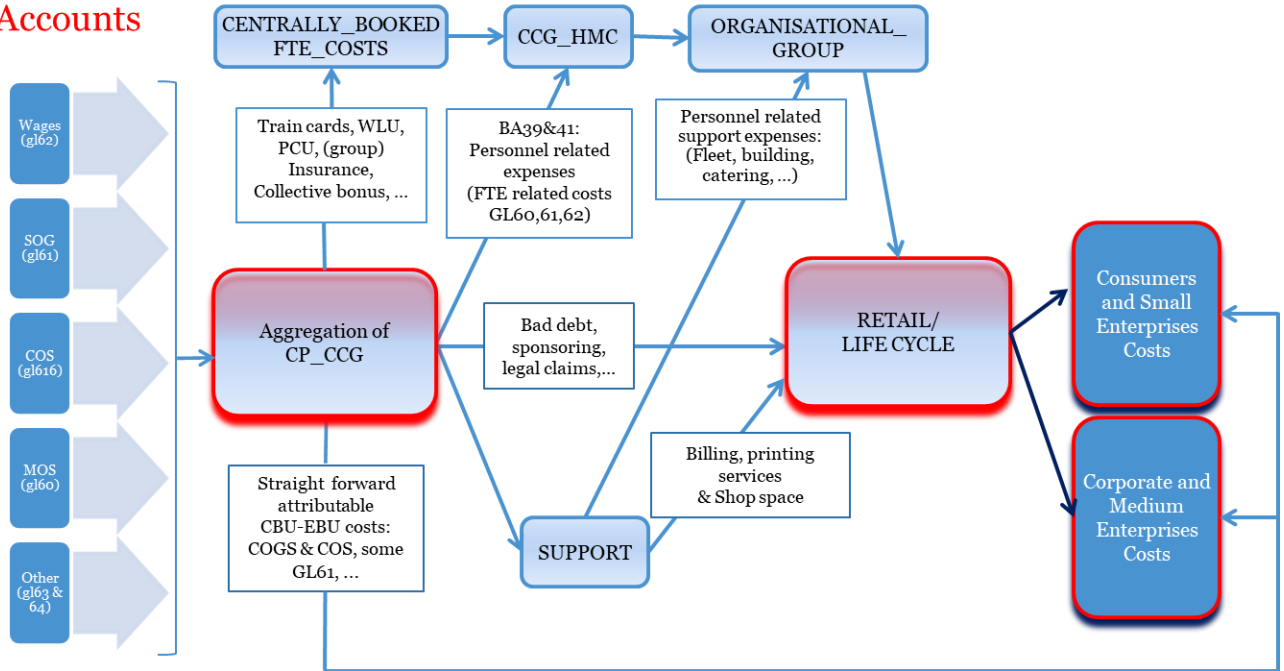

4.3 Allocation of the CWS (Customer Wholesale division) costs

The allocation flow and principles are identical to the retail costs allocation flow.

4.3.1 Wholesale costs perimeter

All Wholesale activities are situated at the level of Business unit CWS (Customer Wholesale).

The Proximus financial and accounting structure clearly registers (directly attributable) Wholesale costs on costcenters 40xxxx.

Starting from the Proximus organisational structure, we can identify 4 blocks in the Wholesale cost perimeter:

1. Wholesale FTE costs
2. Wholesale Support costs
3. Wholesale costs that are not FTE related, nor Support costs, which do not have a direct causal relationship with products
4. Wholesale costs that are not FTE related, nor Support costs, which have a direct causal relationship with products.

Definitions and examples

1. Wholesale FTE costs

Includes all direct FTE related costs of Business unit 40 (GL 62, wages and other salary benefits) and indirect FTE related costs (some GL 61, as travel & representation costs, social benefits such as catering costs, etc.).

Includes also a number of costs that are not directly attributed to Wholesale Business unit in the accounting books but do relate to Wholesale FTE activities. This concerns costs which are centrally booked and/or managed but which need to be flagged towards all Proximus personnel/FTE's (and thus also towards these residing under CWS). E.g.: costs re. Fleet, office building, traincards, bonus, training, gsm's in the context of the employee phone program...

2. Wholesale Support costs

Wholesale Support costs are non FTE related costs which are centrally booked and managed but relate to Wholesale activities. E.g.: Billing.

3. Wholesale costs that are not FTE related, nor Support costs, which do not have a direct causal relationship with products

This block includes costs such as IT developments not capitalized for applications specific to Wholesale departments, costs for legal claims, etc.

4. Wholesale costs that are not FTE related, nor Support costs, which have a direct causal relationship with products

Costs that have an identifiable causal relationship to the products. E.g.: Cost of sales and costs of goods sold, interconnection fee, etc;

4.3.2 Wholesale costs allocation principles

4.3.2.1 *Introduction of 2 cost type attributes*

Two cost type attributes are introduced in the cost model.

These attributes are “VAR_TYPE” and “PS_TYPE” and they constitute a unique combination for each wholesale CP-CCG.

These attribute-qualifications are applied on all the wholesale CP-CCG combinations, but at different levels of modules, depending on the type of costs: FTE related, Support, etc., in accordance with the Wholesale allocation process as described below.

4.3.2.2 *Criteria for attribute dimension VAR_TYPE*

Dimension VAR_TYPE qualifies wholesale costs based on their variability towards product volumes.

We distinguish between 4 var_types:

- Marginal (mar)
- Variable (var)
- Fix (fix)
- Common (common)

As they have stricto sensu the same definitions than for Retail allocation, we refer to the definitions of these 4 var_types as described in chapter 4.2.2.2.

4.3.2.3 *Criteria for attribute dimension PS_TYPE*

Dimension PS_TYPE qualifies wholesale costs based on whether they are specifically generated and/or can be attributed directly or through a specific non generic and/or non general driver towards the specific products.

We distinguish between 2 PS_types :

- PRODUCT_SPECIFIC (PS)
- NON_PRODUCT_SPECIFIC (NPS)

As they have stricto sensu the same definitions than for Retail allocation, we refer to the definitions of these 2 ps_types as described in chapter 4.2.2.3.

In addition to the attribute PS_TYPE, all wholesale costs are flagged with an additional dimension “COST GROUP” enabling to identify the (span of) product(s) it covers.

Used Cost Groups for wholesale costs are:

Non product specific

All CWS products

All CWS products excluding Mobile Roaming

Product specific

Mobile Roaming

Massinternet,Profinternet

LeasedLines,Explore

ICT

Mobile

FixVoiceTraffic

Since this is stricto sensu the same decision tree to qualify wholesale CP_CCG with attributes VAR and PS, than for the Retail allocation process, we refer to the decision tree presented in chapter 4.2.2.3 of the Retail module to illustrate the wholesale costs qualification with attributes VAR and PS.

4.3.2.4 *Allocation of wholesale costs to Markets*

In 2019, the regulatory obligation of accounting separation ceased. As a result, Proximus gathered in a Wholesale Costs market all the specific wholesale markets identified the years before. All the wholesale costs are directly sent to the Wholesale Costs market.

Some objects of activity workforce costs are enriched in their definition with a product complexity factor, used as a basis for determining unit costs of products.

4.3.3 Wholesale costs allocation flows

4.3.3.1 General principles

As described above, the 4 blocks of costs included in Wholesale cost perimeter are all specified with 2 cost type attributes (VAR TYPE; PS TYPE) prior to be allocated to Wholesale Costs market. Similar to the Retail allocation flow, the 4 blocks of costs do not follow all the same path of allocation. The allocation flow followed by a Wholesale CCG_CP will depend on its block of costs (1->4).

4.3.3.2 Wholesale FTE related costs (block 1)

The allocation flow of Wholesale FTE related costs is the same than the Retail one. We therefore refer to chapter 4.2.3.2. for presentation of the several modules whereby FTE related costs are centralized/allocated. As a reminder, the list of modules that deal with FTE related costs is as follows:

- Cost basis (GL62, as well as some GL60&61),
- CCG_HMC or SUPPORT ⁽¹⁾,
- ORGANISATIONAL_GROUP,
- WHOLESALE.

With regard to the definitions of Attribute dimension VAR, Wholesale FTE related costs can only be either Fix (**FIX**), or Variable (**VAR**) costs.

Criteria to classify FTE related costs into FIX vs. VAR costs were similarly defined as for the Retail allocation flow, id est: are considered as FIX costs, all the FTE costs needed to maintain the Proximus minimum organisational structure, independently of products volumes. These ones include staff costs such as IT officers, reporting & analysts teams, research staff (e.g.: products & solutions managers), as well as the Proximus hierarchy structure (team responsables).

Organizational groups dedicated to a specific product are categorized as product_specific (PS). We identified only one organizational group in the Wholesale organisation structure that is product specific, id est, the team involved exclusively in Roaming agreements.

Organizational groups covering a span of products are categorized as non_product_specific.

The classification of FTE costs for CWS between FIX and VAR costs, and whether product_specific or not, is as follows:

CWS Organisational group	FIX/VAR	PS/NPS	Cost Group
Top management	Fix	NPS	All CWS products
Direct Sales	Var (*)	NPS	All CWS products
Call center activities	Mix Fix/Var	NPS	All CWS products
Roaming agreements	Fix	PS	Mobile Roaming
Products & solutions management	Fix	NPS	All CWS products excluding Mobile Roaming
Strategic planning, reporting and internal process	Fix	NPS	All CWS products

(*) excluding Team responsible flagged as Fix costs.

¹ Only FTE related support costs.

CWS Sales department is an organisational group defined as Var, non product specific. CWS sales FTE are responsible for regulated and non regulated products.

CWS Call center activities include 3 main divisions:

- *Operational team* in contact with external clients. This division gathers the Front office and Back office in charge of the sales orders intake, answers to questions of clients, and support to the CWS Sales department in period of high business activity
- *Billing and credit collection team*
- *Reporting, IT tools management and process optimization team.*

Billing and credit collection team is qualified as “fix, non product specific” cost. Billing activity is a cost depending on volumes of clients, not on volumes of products. Billing costs is also a non_product_specific cost, as vast majority of CWS clients have more than one product by Proximus.

Reporting, IT tools management and process optimization team, as Support staff team, is identified as a “fix, non product specific” organisational group cost.

Front office and Back office costs are categorized as “variable, non product specific”, considering the variability of these costs with volumes of products sold, and taking into account that CWS Call center activities handle all CWS products, regulated as well as non-regulated products.

4.3.3.3 **Wholesale support costs (block 2)**

The wholesale support costs are identified firstly in Module “Support”. Wholesale support costs specifically concern “CWS_Billing” (invoice printing, stuffing and postage).

We qualify CWS_Billing as a fix non_product_specific cost. Cost Group of CWS_Billing is All CWS products, since the CWS_Billing support costs include all the products of CWS, whether regulated or not.

As mentioned in chapter 4.3.3.2.3 related to the CWS CCA staff team in charge of Billing and credit collection follow-up, to the contrary of the Retail billing costs, the case that billing costs can be linked to some unique product is not met, since the vast majority of the CWS clients have more than one products billable. The absence or suppression of one product will not change the need for invoicing the client.

4.3.3.4 **Wholesale costs which do not have a causal relationship with products (block 3)**

Per definition these costs are either fix (e.g. IT developments not capitalized for the internal needs of Sales departments, bad debt, etc.) or common (e.g: legal claims).

Per definition, these costs are non_product_specific.

4.3.3.5 ***Wholesale costs which have a causal relationship with products*** ***(block 4)***

Are included in this block of Wholesale costs, all the costs that are not FTE related costs, nor Support costs, that have a causal relationship with products. Costs of block 4 are either directly allocated to the Wholesale Costs market, or they transit by the Commercial_Wholesale module, when the costs have to be gathered in the same Wholesale object at first, prior to be allocated to Wholesale Costs market.

Per definition, these costs have a causal link to products. The causal link to products can be volumes driven (MAR, VAR costs) or not.

Are included in Wholesale costs - block 4, the following combinations of VAR_TYPE ; PS_TYPE:

VAR_TYPE	PS_TYPE	
	Product_specific	Non_Product_specific
Marginal	x	-
Variable	x	x
Fix	x	x

The main costs of this category are Cost of goods sold, cost of sales (e.g: interconnection fees), consultancy and outsourcing costs dedicated to specific products.

Cost of goods sold and Cost of sales, as MAR product specific costs, have a direct link to volumes of product they relate.

Consultancy and outsourcing costs can relate to a specific product. E.g.: Fees to Clearing Offices for roaming.

Wholesale allocation flows of all types of Wholesale costs is presented as follows:

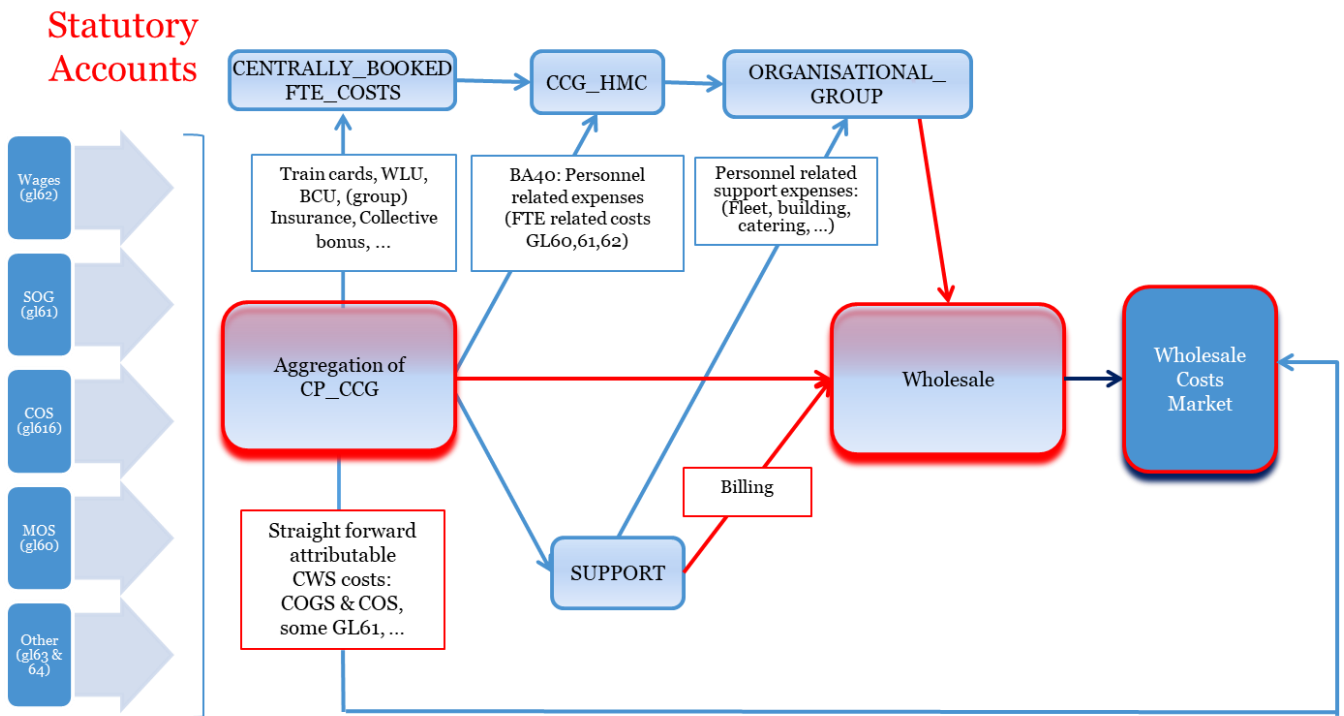

CP = costpool = a grouping of G/L accounts/costs which have similar characteristics and reside under the same nature of costs.
 CCG = cost center grouping = grouping of cost centers with comparable characteristics.

4.4 Allocation of the CUO (Customer operations) retail & non retail costs

4.4.1 Customer operations costs perimeter

Customer operations is a Business unit created in 2014. The division gathers activities previously done inside these Business Units: Consumer Business Unit (CBU), Enterprise Business Unit (EBU), Technology (TEC) and Staff and Support (S&S).

Objective of the creation of the Business unit Customer operations (CUO) was to join in the same Business Unit all the Proximus activities to the service of the customer.

CUO includes both retail & non retail costs. Retail costs concern commercial retail (e.g. commercial call centers) and technical retail activities (e.g. technical call centers). Non retail costs concern the network share of the activities (this is explained in the life cycle chapter).

To ensure consistency with allocations of previous years, we allocate costs of CUO in the same way as done previously inside the separate Business Units CBU, EBU, TEC and S&S, for the CCG concerned.

The Proximus financial and accounting structure clearly registers (directly attributable) CUO costs on cost centers 49xxxx and 50xxxx.

However, a number of costs are not directly attributed to CUO in the accounting books but do relate to CUO activities.

It concerns costs which are centrally booked and/or managed but which need to be flagged towards all Proximus FTE's.

E.g.: costs re. Fleet, office building, train cards, bonus, training, gsm's in the context of the employee phone program ...

These costs are added up with the directly attributable FTE related costs and allocated to CUO CCG towards the organisational groups.

We refer to chapter 4.2.3.2 Retail CBU & EBU FTE related costs, where the allocation flow is described for FTE related costs, as it is applicable to CUO FTE related costs.

For what matters human power costs, the CUO module is primarily sourced from the following modules:

1. **Organisational Group**
This concerns the CUO FTE related costs.
2. **CP1**
This mainly concerns the outsourcing costs for the field and remote technical activities (provisioning and repair).
3. **CUO SOG**
This primarily concerns costs for the outsourcing of commercial call centers (front office and after sales).

4.4.2 Customer operations costs allocation principles

4.4.2.1 *Introduction of 2 cost type attributes*

Two cost type attributes are introduced in the cost model.

These attributes are “VAR_TYPE” and “PS_TYPE” and they constitute a unique combination for each Customer operations CP-CCG.

4.4.2.2 *Criteria for attribute dimension VAR_TYPE*

Dimension VAR_TYPE qualifies customer operations costs based on their variability towards product volumes.

We distinguish between 2 var_types:

- Variable (var)
- Fix (fix)

As they have the same definitions than for Retail CBU & EBU allocation, we refer to the definitions of these 2 var_types as described in chapter 4.2.3.2. Retail CBU & EBU FTE related costs.

4.4.2.3 *Criteria for attribute dimension PS_TYPE*

Dimension PS_TYPE qualifies CUO costs based on whether they are specifically generated and/or can be attributed directly or through a specific non generic and/or non general driver towards specific products.

Considering the activities of CUO Business unit (activities of services to the customer), most of the costs are non product specific.

4.4.3 Customer operations costs allocation flows

4.4.3.1 Allocation of Organisational Group costs

The classification of FTE costs for CUO between FIX and VAR costs, and whether product specific or not, is as follows:

CUO Organisational group	FIX/VAR	PS/NPS	Cost Group
Top management	Fix	NPS	All Proximus products
<u>Support services to the business unit</u>			
Strategic planning	Var (*)	NPS	All Proximus products
E2E operations: IT tools, reporting & process	Var (*)	NPS	All Proximus products
<u>Technical services to the customer</u>			
After sales technical - provisioning (1)	Var (*)	NPS	All Proximus products
After sales technical - repair (1)	Var (*)	NPS	All Proximus products
Field Cable	Var (*)	NPS	All Proximus products
<u>Commercial services to the customer</u>			
After sales commercial (2)	Var (*)	NPS	All CBU and CWS products
Front office and After sales commercial	Var (*)	NPS	All EBU products
Directory Information Services	Var (*)	PS	Directory Assistance Services and listing
Billing & Collecting invoices	Fix	NPS	All CBU and EBU products

(1) Remote and field

(2) Back office of Telesales agents for provisioning and complaints handling

(*) excluding Team responsible flagged as Fix costs

Technical services to the customer

The allocation for fix & var organizational groups is theoretically the same. There are exceptions to this principle, in which case the fix allocation, mostly, directly goes to Common Costs market. The later applies when variable costs of a team are sent to the life cycle and this team serves both retail & regulated products.

The FTE related costs of organizational groups are mostly allocated to the LIFE_CYCLE, modules of Network elements or MARKETS based on time or efforts spent for these respective elements, as registered in various reporting systems depending upon the department (Dispatch units for Field operations, Minutes of interactions with the customer for the remote repair of mass products, etc.).

Commercial services to the customer

- When the costs relate to a specific business unit, Consumer business unit or Enterprise business unit, the costs are directly allocated to the business unit related market.
- Directory Information Services costs are allocated directly to the *Consumers and Small Enterprises Costs market*, as part of consumers' activity.
- Billing and Collecting invoices activities are split between *Consumers and Small Enterprises Costs market* and *Corporate and Medium Enterprises Costs market* according to turnover of the two divisions CBU and EBU, the two beneficiaries of this CUO service.

Costs of Organisational groups of CUO being sent to module LIFE_CYCLE prior to be allocated to markets, we refer to Chapter 4.5. for more developments on allocation keys of CUO Organisational groups.

4.4.3.2 *Allocation of Outsourcing costs*

Outsourcing costs include:

- costs gathered in module CP1 for technical teams and
- the commercial call centers outsourced (front office and after sales).

When activity is similar, outsourcing costs are allocated with the same drivers (based on time/efforts) than used for the Organisational groups. When activity is specific, dedicated allocation keys were applied.

Outsourcing costs of CUO being sent to module LIFE_CYCLE prior to be allocated to markets, we refer to Chapter 4.5. for more developments on allocation keys of CUO Outsourcing costs.

4.5 Allocation of retail costs in the Life cycle of products

4.5.1 Cost perimeter

Since the 2014 Cost model, all the retail costs included in the life cycle of a product/service were specifically gathered in a module, the LIFE_CYCLE MODULE, prior to be allocated to Markets. The costs were sourced primarily from modules OTHER_MOS, OTHER_SOG, COMMERCIAL_RETAIL, AC and CUSTOMER_OPERATIONS

In the 2019 model, we introduce for the first time separate fiber-related technical activities whenever the fiber costs are identifiable. In the past, CUO only dealt with copper. But CUO now also deals with fiber in line with the announced gigabit network strategy of Proximus translating into a.o. the deployment of a fiber network. So please do read copper & fiber whenever you see copper in the tables below.

Also note the ISO team (remote professional repair activity) transferred back from EBU to CUO.

The life cycle of a product includes the following stages:

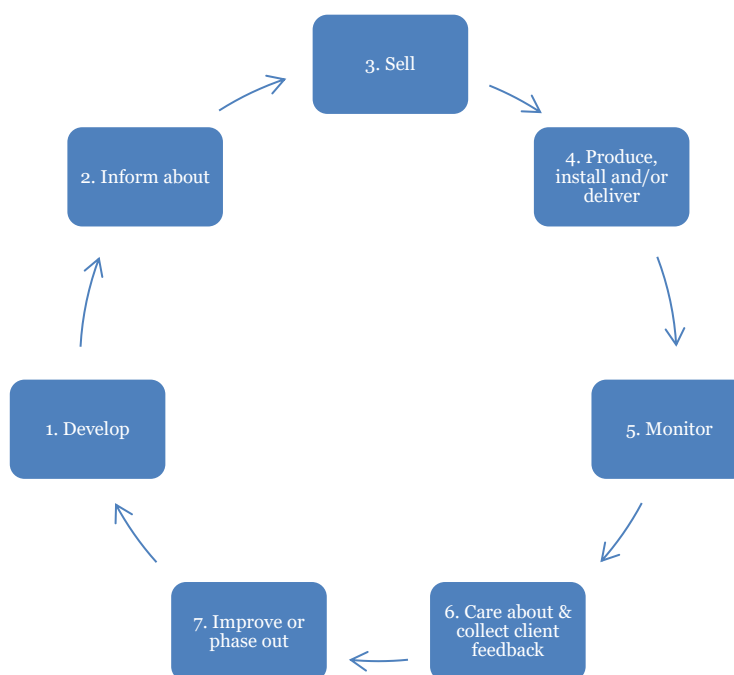

Following costs were identified in the life cycle of a product/service:

<p>DEVELOP</p>	<ul style="list-style-type: none"> ➤ Develop product configuration ➤ Target market & analyze financial impacts ➤ Develop aspects for sales channels: training, shops equipment, processes 	<p><u>GL62 wages:</u> Product & solutions managers Business & financial analysts Project managers</p>
<p>INFORM</p>	<ul style="list-style-type: none"> ➤ Organize marketing campaigns 	<p><u>GL61 SOG:</u> Marketing campaigns expenses</p> <p><u>GL62 wages:</u> Marketers</p>
<p>SELL</p>	<ul style="list-style-type: none"> ➤ Acquire gross gains of products: new client and existing client, via All sales channels: <ul style="list-style-type: none"> ○ Call center agents ○ Direct sales ○ Indirect sales ○ Web sales 	<p><u>GL60 COGS-MOS:</u> CPE equipment</p> <p><u>GL61 COGS & SOG:</u> Commissions indirect sales (Cogs) Call center agents outsourced (SOG)</p> <p><u>GL62 wages:</u> Call center agents insourced Direct sales</p>
<p>PRODUCE, INSTALL & DELIVER</p>	<ul style="list-style-type: none"> ➤ Deliver gross gains of products acquired. More an activity of technical departments, to the exception of some products, delivered in shops (e.g.: mobile products) 	<p><u>GL61 COGS:</u> Interconnection costs (Telco/ICT) to various platforms, idTV content fees</p> <p><u>GL62 wages:</u> Direct sales</p>

DELIVER :
Remote activation

- All products (mass or professional, fixed or mobile) must be remotely activated in the network.
- The remote activation may be sufficient to deliver the product in specific cases but in many cases, a field travel is necessary to complete the product delivery.
- Ideally, the remote activations would all be automatically executed further to an order from the customer in the IT systems but in reality, this process still requires manual interventions.
- The complexity of professional remote activations naturally requires a specific and important team (CNN). The activation activity in the life cycle refers to CNN.
- The PCD (Provisioning Coordination Desk) mass remote activation activity is consolidated with the dispatching activity in the DCO included in the field installation life cycle activity.

GL61 SOG:
PCD (Provisioning Coordination Desk) in the DCO (Dispatch & Coordination Center) (CUO/ASA/DCO), CNN (Professional Connectivity)

GL62 wages:
PCD (Provisioning Coordination Desk) in the DCO (Dispatch & Coordination Center) (CUO/ASA/DCO), CNN (Professional Connectivity)

DELIVER :
Field installation

- A remote activation of the product in the network may not be sufficient, especially in the case of fixed products.
- In that case, a technician (insourced or outsourced) must travel to the field in order to complete the necessary actions :
 - in the network up to the NTP (Network Termination Point in the customer house) (even DIY installations by the customer may require a field action in the network) and/or
 - outside of the network e.g. for mass products, the modem and/or TV decoder (FULL installation).
- The field installation activity in the life cycle relates to the work done by the technicians outside of the network.
- It also includes the remote activation (for mass products) as well as the dispatching activities from the DCO.

GL60 MOS-MAT:
Equipments like modems and/or TV decoders, located in "Terminals" life cycle various categories

GL61 SOG:
Copper
DCO (Dispatch & Coordination Center), CUO CFF MP (Customer Operations Customer Field Force Mass Professional) fulfilment

GL62 wages :
Copper
DCO (Dispatch & Coordination Center), CUO CFF MP (Customer Operations Customer Field Force Mass Professional) fulfilment

<p>MONITOR: Billing & Collecting Revenues</p>	<ul style="list-style-type: none"> ➤ Produce and send bills ➤ Manage bad debt: follow ageing balance, send reminders & bailiffs costs 	<p><u>GL61 SOG:</u> Printing & postage costs Bailiffs costs</p> <p><u>GL62 w ages:</u> Call center agents insourced (dedicated team Billing&Credit risk)</p> <p><u>GL 63&64 Other:</u> Bad debt provision & write-off</p>
<p>MONITOR: Changes on products sold</p>	<ul style="list-style-type: none"> ➤ Adapt product configuration, in accordance with requirements of the client: swap, downgrade/upgrade of a pricing plan, additional option, churn, configure multiple products in a pack (pack configuration) 	<p><u>GL61 SOG:</u> Call center agents outsourced</p> <p><u>GL62 wages:</u> Direct sales, Call center agents insourced</p>
<p>CARE: Handling clients complaints</p>	<ul style="list-style-type: none"> ➤ Handle billing complaints ➤ Process request for changes of personal data (clients moves, etc.) 	<p><u>GL61 SOG:</u> Call center agents outsourced</p> <p><u>GL62 wages:</u> Call center agents insourced, Direct sales</p>
<p>CARE: Remote repair</p>	<ul style="list-style-type: none"> ➤ When a customer has a technical issue with a product/service, he/she can contact the appropriate call center (mass or professional). Whilst the customer is waiting on e.g. the CHC line, the DARE IT system already processes the customer data in order to test potential issue drivers. ➤ The first line call center agent may be able to fix the issue of the customer ... or not. <ul style="list-style-type: none"> ➤ In the later case, the call center agent will call upon the second line agents who themselves will call upon a third line outside of CHC or ISO if they can't fix the issue. ➤ The remote repair activity in the life cycle relates to the CUO CHC (Customer Operations, Customer Help Center, for mass products) and the EBU OPS ISO (Operations,ICT Service Operations - Information & Communication Technology - for professional products) 	<p><u>GL61 SOG:</u> CUO CHC (Customer Operations, Customer Help Center) for mass products) and EBU OPS ISO (Operations,ICT Service Operations - Information & Communication Technology) for professional products</p> <p><u>GL62 w ages:</u> CUO CHC (Customer Operations, Customer Help Center for mass products) and EBU OPS ISO (Operations,ICT Service Operations - Information & Communication Technology) for professional products</p>

CARE:
Field repair

- A remote repair of the customer technical issue for one or several products may be impossible, be it by the first, second or third line.
- In that case, a technician (insourced or outsourced) must travel to the field in order to complete the necessary actions :
 - in the network e.g. the ROP, the LEX, the NTP (Network Terminating Point, in the customer house) and/or
 - outside of the network in the customer office for professional products or house for mass products (e.g. the modem, the TV decoder).
- The field repair activity in the life cycle relates to the work done by the technicians outside of the network.
- It also includes the dispatching activities from the DCO (Dispatch & Coordination Center).

GL61 SOG:

Copper
DCO (Dispatch & Coordination Center) (CUO/CFF/DCO), CUO CFF MP (Customer Operations Customer Field Force Mass Professional) repair

GL62 wages :

Copper
DCO (Dispatch & Coordination Center) (CUO/CFF/DCO), CUO CFF MP (Customer Operations Customer Field Force Mass Professional) repair

CARE:
Retention & Loyalties programs

- Inform about loyalties actions & facilities,
- Implement retention actions

GL60 MOS-MAT:

Sales gifts and loyalties advantages

GL61 SOG:

Call center agents outsourced

GL62 wages:

Call center agents insourced

IMPROVE or PHASE OUT

- Design product new configuration/phase out
- Target market & analyze financial impacts
- Develop aspects for sales channels: training, shops equipment, processes

GL62 wages:

Product & solutions managers
Business & financial analysts
Project managers

4.5.2 Allocation drivers

Commercial services to the customer

Since 2019, there are no more Retail product regulated market, the market for Fix Voice access being deregulated. We updated accordingly our definitions of the markets and merged the market for Fix Voice access with the one of the other not regulated Retail products.

In this framework, combined with the significant convergence between products in the Mass market, we did not split allocation of retail costs to Life_cycle (and to market afterwards) between Retail products.

As from the the Cost model 2019, commercial services to the customer are directly allocated to objects of the Life_cycle. The costs allocated directly are split per type of activity: sales, after sales, billing, cogs, ...

The costs of the Retail activities in the Mass market are completed with a volume corresponding to the total park of products Mass market at year-end, completed by the number of Mass market customer accounts to handle. This volume can be used as a basis for determining Retail Mass market unit costs. The Retail unit cost is equivalent for each Mass market product.

At the side of Corporate and Medium enterprise Retail costs, products catalog is widely more diversified than for Mass market products. Per product in the Enterprise Market, we modeled a complexity factor. This latest can be used as a basis for determining unit costs per products of Retail activities of the Enterprise market.

Technical services to the customer

Allocation drivers for VAR costs to the Life_cycle module are the following ones:

	<u>Sourced from Module(s)</u>	<u>Driver for allocation to Life Cycle split per product and customer segment</u>
<u>Technical services to the customer</u>		
Customer activation	Customer_Operations	SAP HR teams names and configured nodes
Customer field installation&repair on copper&fiber	Customer_Operations	DU (Dispatch Units) translating time spent on activity
Customer remote repair, mass market products	Customer_operations*	#FTE and minutes
Customer remote repair, prof. market products	Customer_operations*	#FTE and cumulated nodes
<u>*prof. market products :</u> CUO OPS ISO (Operations - ICT Services operations)	<u>mass market products :</u> CUO CHC (Technical call center)	

4.5.3 Modern equivalent opex (MEO)

The 2014 Cost model introduced the concept of modern equivalent opex: a company will perform an activity with its own personnel, if the use of its own personnel is equivalent in costs to another business model such as partnership, outsourcing, interim workers, commissioning, etc.

The MEO introduces a new way to determine VAR costs. Objective of the MEO is to only keep as VAR costs the incremental, effective costs needed to perform an activity, by comparing unit cost of FTE Proximus with unit cost of Outsourcing.

MEO concept application requires some basics:

- comparison basis is reliable: activities insourced and outsourced must be of the same nature,
- same drivers must be available to compare both costs.

MEO application to Commercial activities:

Proximus outsources part of its commercial activities: direct sales, front office and after sales. These activities are also performed with Proximus FTE, as described above.

Direct sales and After Sales team cannot appropriately be compared to their outsourced equivalent teams: performance remuneration differs, tasks differ quite also.

E.g.: After sales outsourcers are used for specific tasks, often easier than the ones assigned to Proximus FTE, more trained and skilled about Proximus products and IT Tools.

The only sales channel where we can apply the MEO valuably is the Front office.

Front officers:

- use the same Proximus IT tools (Interactive Virtual Response), where volumes and minutes of calls are registered.
- perform the same tasks: receive phone calls of clients and promote Proximus products & services.

Unit cost/minute of the Front office Outsourced is applied to volumes of minutes of the Front office Insourced, to determine the MEO Front office VAR costs, other part of cost is considered as a Fix cost.

MEO application to Technical activities:

CUO outsources part of its VAR Retail activities: remote repair (by the CHC/Customer Help Center technical call center), field installation and field repair. These activities are also performed with Proximus insourced FTE, as described above.

The CUO CHC technical center second line may not come into consideration for MEO: tasks differ from the first line ones and cannot be measured the same way. However, tasks of outsourcers for both field installation and field repair do not differ and can be measured the same way, as well as tasks of outsourcers for the CUO CHC technical center first line.

MEO is thus valuably applied to the CHC technical call center first line as well as the field installation & the field repair.

Front officers (the first line of the CHC technical call center for remote repair):

- use the same Proximus IT tools & volumes and minutes of calls are registered the same way.
- perform the same tasks: receive phone calls of clients and try to remotely repair the products.

Technicians (for both field installation and repair) :

- use the same Proximus IT tools & volumes and DU are registered the same way.
- perform the same tasks: install and repair products/services of customers on the field.

Unit cost/minute of the Outsourced Front office is applied to volumes of minutes of the Insourced Front office, to determine the MEO technical Front office VAR costs, other part of cost is considered as a Fix cost.

Unit cost/DU (measure of time) of the Outsourced Technicians is applied to volumes of DU of the Insourced Technicians, to determine the MEO Technicians VAR costs, other part of cost is considered as a Fix cost.

5 TEC OPEX (network&IT) stream

5.1 Allocation of TEC OPEX costs going through the “TECHNOLOGY” INCA module

5.1.1 Determination of the TEC cost perimeter

As stated previously the Proximus organisational structure distinguishes between 5 distinct organisational pillars called Business units :

- Consumer Business Unit (CBU) has the responsibility over the residential and small enterprise customers
- Enterprise Business Unit (EBU) has the responsibility over the professional customers
- Customer Operations (CUO) has the responsibility to deliver (commercial and technical) services to customers such as provisioning, after sale and repair
- Technology (TEC) module in the Cost model centralises Network and IT services. In the organization of Proximus SA, TEC activities are done in 2 Business Units created in July 2020: Network Business Unit and Digital Transformation & IT Business Unit.
- Staff and support (S&S) groups all horizontal functions sustaining the Group activities

Commercial retail activities are situated at the level of Business unit CBU (consumer business unit) for the residential and small enterprise customers and at the level of Business unit EBU (enterprise business unit) for the other professional customers (medium and corporate enterprises).

Technical retail activities are a priori situated at the level of Business unit CUO (Customer Operations). Yet CUO also entails commercial retail activities & non retail costs (the network share of the technical activities). Network & IT activities are situated at the level of Business unit TEC, as well as the carrier & wholesale activities (CWS).

The Proximus financial and accounting structure clearly registers (directly attributable) TEC costs on cost centers 50xxxx, separately from the wholesale costs booked on cost centers 40xxxx.

However, a number of costs are not directly attributed to TEC in the accounting books but do relate to TEC activities.

It concerns :

1. FTE related costs
Support and centrally booked costs which need to be ventilated towards all Proximus personnel/FTE's (and thus also towards these residing under TEC).
E.g. Proximus University, Fleet, office building, train cards, bonus, training, gsm's in the context of the employee phone program.
2. Non FTE related costs
Costs which are centrally booked and managed but relate to TEC activities such as space and power consumption.

The costs under point 1. above are added up with the directly attributable FTE related costs (essentially all payroll costs and costs categorized with Cost type 'personnel-related' in the cost base, in lesser extent a limited number of costs categorized as 'non personnel-related', i.e. primarily training costs, printing costs and cost for office equipment) and allocated towards the organisational groups (as a general rule, the organisational group corresponds with the cost center group - except for teams like hybrid network & IT CCG's (SPC NSC)).

The TECHNOLOGY module costs are primarily sourced from the following modules :

1. Organisational_Group
This concerns the costs of "50xxx" organisational groups not belonging to CUO.
2. TEC_SOG
This primarily concerns costs for consultancy, rent/buy equipment.

5.1.2 TEC cost allocation

5.1.2.1 Introduction of 2 cost type attributes

Two cost type attributes are introduced in the cost model.

These attributes are "VAR_TYPE" and "PS_TYPE".

For TEC, these attribute qualifications are not defined at the level of the cost base for all CP-CCG combinations but only for the FTE related costs at the level of the organisational groups (module "organisational_group").

5.1.2.2 Criteria for Attribute dimension VAR_TYPE

Dimension VAR_TYPE only qualifies TEC FTE-related costs in the TEC module, unlike in the commercial retail module.

Variability refers to the service volume produced by the company in the long-run. This variability has 2 dimensions : volume within a product or diversity of products. The considered increment is the whole product. E.g. PSTN : what if we stop PSTN, which costs do we avoid? This is very hard to reach, especially in a top-down model.

Therefore, we prefer to opt for a simple approach that is only an approximation of the minimum fixed costs, by only considering as fixed FTE-related costs the so-called overhead teams and the minimum organizational structure, represented by the persons attributed with a "team responsibility" or in an MST cost center, as officially reported in the SAP accounting system.

We distinguish between 2 var_types only (unlike Retail CBU & EBU, with 4 var types):

1. Fix (fix) : TEC FTE-related costs are considered as fixed mainly when they are related to the minimum organizational structure (represented by the team responsables and the Management & support teams) should there be a change in the long run.

2. Variable (var) : TEC costs which are not considered as fixed according to the definition hereabove (hence overestimated).

5.1.2.3 *Criteria for attribute dimension PS_TYPE*

Dimension PS_TYPE qualifies TEC costs based on whether they are specifically generated and/or can be attributed directly or through a specific non generic and/or non general driver towards the specific products.

We only have one category in the TEC module :

- a. NON_PRODUCT_SPECIFIC : TEC costs which do not have a clear (causal) relation with specific products.

TEC MODULE : VAR & PS TYPE

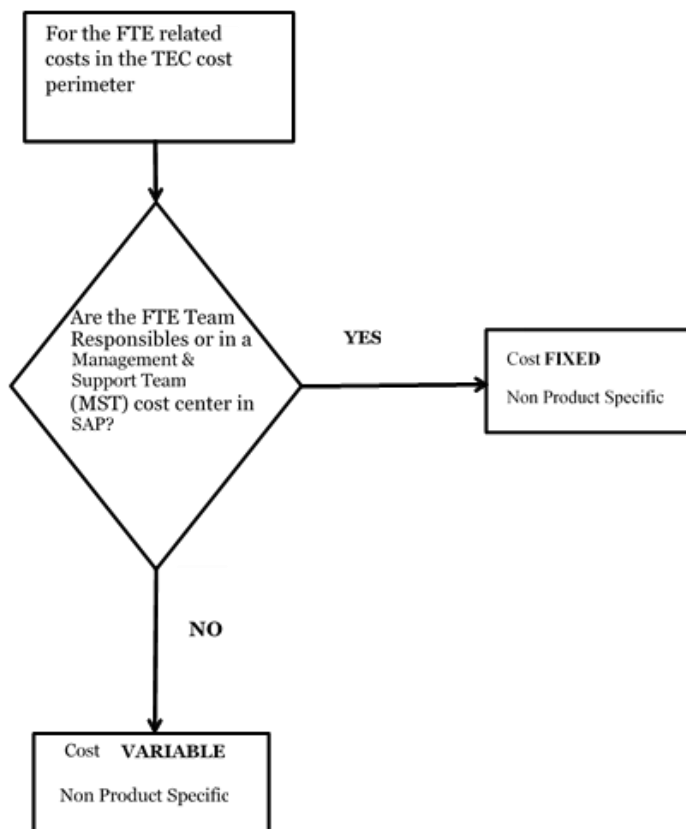

5.1.3 TEC allocation process

5.1.3.1 Allocation of “Organisational_Group” costs

For TEC, the organisational groups a priori correspond with the cost center groupings as introduced at the level of the cost base.

The criteria as set above (5.1.2.2.) regarding variability are currently translated towards organisational groups based on this decision table :

Criteria	Justification
fix FTE	
Assigned as Team responsible in SAP	Assumption of Proximus as ongoing concern on the long run, independent of Product mix : maintain the same organisational structure (reflected through team respo's)
Assigned to an MSTcost center in SAP	MST cost centers are referring to Management & Support teams

Organisational groups dedicated to a specific product are categorized as product_specific.

Organisational groups covering a span of products are categorized as non_product_specific.

In TEC, all organisational groups have been defined as “non_product_specific”.

Except for the NEO (Network Engineering & Operations) department, where as of the 2018 model this parameter is used to give the type of network activity the team relates to (e.g. fixnetwork, radio& access network...).

The allocation for fix & var TEC organizational groups is a priori the same.

The FTE related costs of organizational groups are allocated towards markets, network, activities or IT elements based on time or efforts spent for these respective elements, as registered in various reporting systems depending upon the department (Rapid for SPC...).

5.1.3.1.1 Technology (TEC) Organisational group allocation

5.1.3.1.1.1 TEC network & IT OPEX organizational group allocation

The network & IT teams of TEC are thus split into fix and var on the basis of objective criteria found in SAP but allocated the same way (var being a copy of fix) to the following elements :

- AC2
- BUSINESS_OVERHEAD
- CP2
- IT_SW_HW
- IT_STORAGE_DB
- NE
- OVH
- MARKET

In the TEC module, the organisational groups do not only encompass the costs of GL 62 wages but also FTE-related costs from GL60 MOS or GL 61 SOG, whilst outsourced personnel costs (for 2 CP mainly : 61361 & 61362) have been consolidated into a new module (EXTERNALS).

The driver is based on time/efforts when it makes sense.

The allocation of the “operational” teams is done directly through the driver whilst the allocation of the “non operational” teams is done through generic keys taking into account the scope of the “non operational” team (driver is the remuneration cost allocation of all the teams in the scope of the “non operational” team).

The allocation of the “fix” part of the “operational” teams is done through generic keys or via a simple copy of the remuneration cost allocation of the “var” part of the same operational team.

5.1.3.2 *Allocation of TEC support costs*

Module ‘Support’ identifies and collects the costs of a number of support objects which a.o. are TEC related. The TEC related support objects primarily concern costs for telco power & space. However, telco power & space costs are not treated in the TEC module and are thus not described in this subchapter.

5.1.3.3 *Graphical view on TEC OPEX allocation flow*

Please note that the markets have been adapted as from the 2019 year model as follows :

All Common Costs
Wholesale Costs
Consumers and Small Enterprises Costs
Corporate and Medium Enterprises Costs

Indeed there is no legal obligation to report regulated markets anymore.

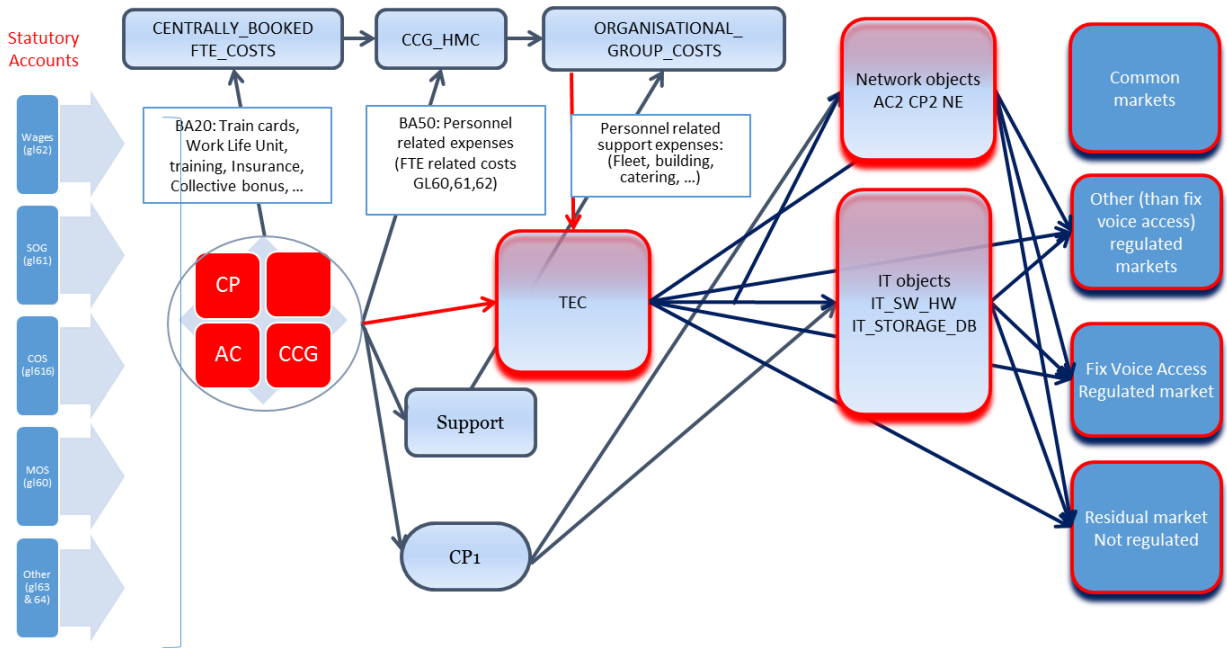

CP = Cost Pool = a grouping of G/L accounts/costs which have similar characteristics and reside under the same nature of costs. Typically, the G/L accounts/costs consolidated in a single cost pool feature the same causal relation.
 CCG = Cost Center Grouping = grouping of cost centers with comparable characteristics
 AC = Asset Class

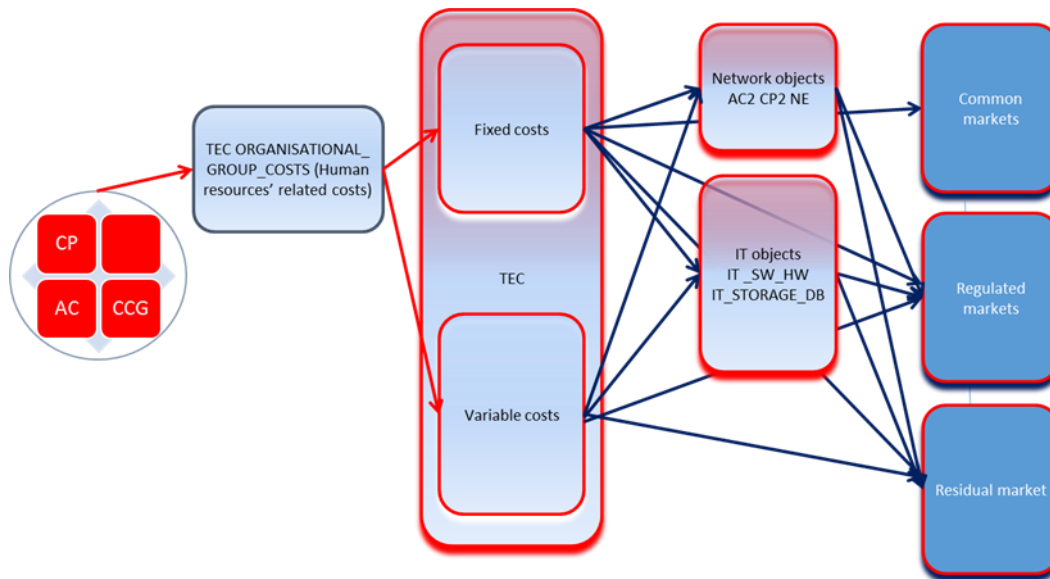

Figure 2: TEC

OPEX Flow – General

Figure 3: TEC OPEX Flow – Fix / Var

5.2 Allocation of TEC OPEX costs not going through the “TEC” TCE module

5.2.1 GL61 accounts – Services and Other Goods (SOG)

The GL accounts in the 61 range mainly register outsourcing, consultancy, renting & maintenance costs as well as miscellaneous costs driven by staff (GSM, memberships, office material, internal events etc.).

As of the 2018 year model, it's been decided to decrease the number of consolidated allocations not going through the TEC TCE module for transparency reasons. A new module has been created (EXTERNALS) where the respective gross & capex most material GL 61 accounts are registered by team. Indeed that is a particularity of the Technology business : the capexization level of the human resources (whether they be internal or external) tends to be quite high and there is a high added value in reporting this transparently by team.

So as a consequence of this change, the most material GL 61 accounts to this date not going through the TEC module are pylons & spectrum as well as IT software and hardware sent respectively to the NE (Network Elements) module and the IT SW HW module.

5.2.2 GL60 accounts – Material Out of Stock

The GL60 account costs cover the cost of all kinds of material taken out of the stocks of Proximus and used for the repair and provisioning of network or the cost of small items (office material, GSM,...) consumed by the staff in the context of their daily activities.

Note that movements from stock also occur for the construction of the network; these costs are capitalized. The capitalized MOS costs are implicitly treated with the assets. The opex MOS costs are not material and are allocated along with the main costs of the team where they have been booked.

6 IT stream

6.1 IT Allocation flow

6.1.1 IT allocation flow: Introduction

The IT model can be summarized by the following drawing representing the different IT Modules as defined in the IT model, as well as describing objects contained in each of them. The creation of these modules and objects will be detailed in the following paragraphs as well as how they are allocated to each market through an allocation which uses causal and generic keys created with data available in different inventories or reporting systems within the company.

ICT is the use of programs with a specific infrastructure to deliver a requested service or product to the end-user (which can be a Proximus Client or a Proximus Employee/Contractors). In Telecommunications, an incumbent ISP will rarely develop an Application or invest in a project exclusively for one regulated product or market. Most of the time, its specifications will cover multiple usages. Therefore, the goal of this model is to regroup all capitalized and operational costs in order to allocate them to the network allocation flow or the regulated/residual markets

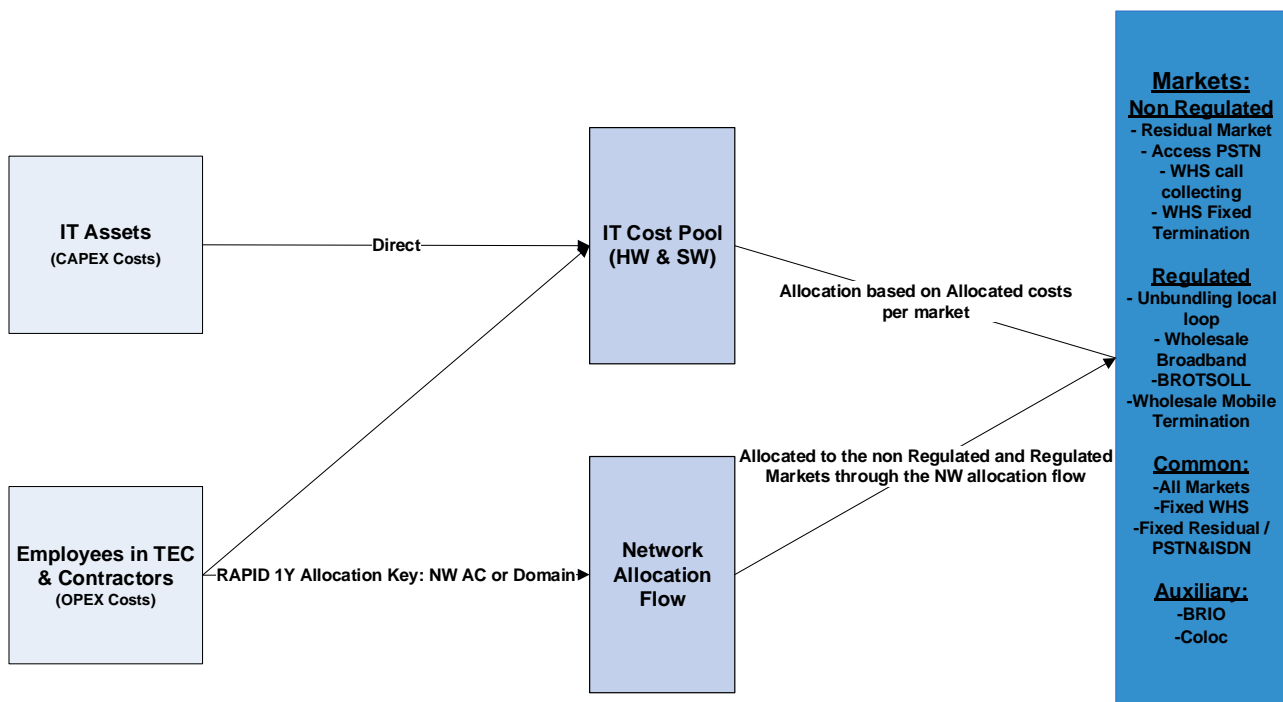

IT Allocation Schematics for 2016

Since 2016, the allocation of IT costs has been rationalized in its scope. This resulted in two main differences compared to last years: the merging of previous modules IT hardware and IT Software into one IT Cost pool and the allocation towards the Market module based on a generic key instead of volumes.

The allocation stream goal stays the same as it is to link the costs for manpower and infrastructure that are used in order to create, run and maintain applications, components and projects to the markets defined in the regulatory model.

These costs can be of two different types: capitalized and therefore depreciated following accounting rules (for IT, depreciation length is generally 4 or 5 years), or operational and fully charged for the current year. Depending of the cost's nature, the allocation stream will follow different paths (IT, IT&NW and overhead) and use specific inventories and reporting systems in order to create the optimal allocation keys.

6.1.2 Data sources: IT Inventories and Reporting Systems:

Internal IT Databases:

The main database used in the model is the "Configuration Management Database" (CMDB) which populates and links together all IT related objects in Proximus, such as which databases are used by an application, or what is hosted on a server. This is used primarily for incident management. This repository is fed by operational inventories from each category of IT machine.

IT Asset Manager (ITAM) is the inventory for all IT equipment with a reference to its cost and is used by Finance to calculate yearly the costs for IT hardware Assets.

ARIS is a recent initiative to install a business process modeling tool which allows the aggregation of applications and to understand fully their purposes.

Reporting Systems:

Rapid² is a tool used for projects, budget and capacity management related processes, with interfaces to other core systems such as SAP HR (human resource & organization units data) , SAP Finance (actuals, purchase order..), IMD (release Management) and timesheets applications (used by TEC to report their day-to-day work). Rapid will be used to calculate allocation keys for most manpower costs for TEC regarding both Capex (allocation of Assets ranging from 2526 to 2573) and Opex. All assets tagged as pure IT are all pooled together in the IT SW HW module.

TM1 is an interface from excel to SAP allowing the extraction of Data coming from Finance and HR. It completes our asset reconstruction for the non-workload costs.

6.1.3 Modules and Objects composing the IT allocation flow

IT Servers

A server is a set of hardware running as a service to serve the needs or requests of others programs or users.

² Repository for the Administration of Projects and Initiatives in a Decentralized way

Splitting the server asset between these families was achieved by using the cumulated purchase costs of these families which is provided by Finance. This calculation is made possible by the inventory maintained in ITAM.

IT Assets allocation:

All tagged IT assets that follow are directly allocated to the IT Software and Hardware module.

- **2500 Servers (Inclus. Tandem)**

Servers can be used by applications (software sold by a vendor or developed in-house) and databases or for interconnectivity and security. This asset pools most of servers families used within the company such as Windows, Linux, UNIX, Teradata and Tandem technologies. Accounting distinguishes the following families: Wintel (Windows for Telecommunication), UNIX (with Linux pooled in this family), Teradata and Tandem. Keys are created from Finance inventory analysis in order to allocate costs to each family.

- **2501 Storage:**

Storage is used both as a core business as well as a support for employees and customers. It is required in order to run applications and databases, create backup and archives to save an employee's work or a customer's information (regarding billing or call details records for instance).

- **2502 Mainframe BS2000 HW & 2503 BS2000 Software:**

Mainframes are powerful computing platforms used for critical applications. They can be considered as multiple servers within one machine. Sensitive applications and data that require heavy computing power are hosted on them. It requires specific software to run which costs are pooled in the 2503 BS2000 Software asset. The mainframe park has been updated to the Z-Series manufactured by IBM.

- **2504 IT Internal Network**

IT Internal Network is an asset representing Proximus Intranet, required to support the needs of employees as well as the interconnection needed in order for the different IT objects to communicate.

- **2505 Office Automation**

Office Automation pools IT costs and improves productivity such as development environment, printing servers and Digital Workspace.

- **2506 End user IT Device**

Concerns IT material made available to Proximus employees such as laptops and desktops.

- **2523 Major Software Application:**

This is a specific asset that pools applicative mobile costs. It contains IT sub-assets as well as some network-related ones due to historical reasons. Timesheets reports from RAPID are used to allocate this asset.

- **2525 Application Software Other:**

“Application Software Other” is an asset for all Capex licenses costs that are not pooled in another IT asset (licenses costs for minor applications for instance). It is heavily related to productivity enhancements and office automation.

- **2526 Applic SW IMA:**

All costs related to the **Identify Management (IMA)** application are assigned to this asset. IMA identifies all Proximus users.

- **2529 Appl SW Middleware:**

Although named Middleware, this asset is composed of developed applications playing the role of a middleware inside Proximus IT infrastructure. It has to be distinguished from some costs objects in System Software and Application Software Other that also have middleware costs such as Websphere licenses. This asset pools IT domains from:

- A **Business Process Modeler** which delivers a process integration platform for enterprise services based on service-oriented architecture.
- A **Service Oriented Architecture** layer.
- A **SOA Services Repository** to document and describe all SOA services.
- And a **Hub Contract Software** used as a middleware connectivity tool.

- **2530 Applic. SW PILA:**

Pila Asset is a cluster of applications and components related to the **Order handling Management System (OMS)** with all its bridges with provisioning systems and a customer relationship management interface with BCI as well. OMS is one of the main contributors to this asset, as is the **Network Provisioning System** linking OMS with provisioning systems and the **Order Flow Application** (an interface between BCI and OMS). In the process of being phased out and replaced by the MCOM system. (which is accounted in its related sub-asset from the 2547 asset)

- **2531 Applic. SW BCI:**

The Proximus Channel Integration (BCI) is a customer relationship management tool for all call-centers-enabling a real-time customer information input or output in order to improve the feedback a customer receives when calling Proximus helpdesks.

- **2532 RID(Reference Inventory&Design):**

RID is an asset related to inventories and documentation.

- **2533 Applic. SW WFMS**

The **Work Force Capacity Management** tools (WFM) asset pools all costs related to the automation of the dispatching on the field of all Proximus technicians including a scheduler and reporting system.

- **2534 Applic. SW UTS**

The **Unified Trouble Ticketing System** (UTS) is a system used in order to register and follow-up trouble tickets pro-actively and reactively.

- **2535 Applic. SW Cust Relationship Management**

This asset is composed of two applications related to the selling process and are directly linked to CRM: **Customer Sales Assistant** (CSA) and **Customer Value Management** (CVM).

- **2536 Appl SW COB**

This asset pools costs from the **Customer Oriented Billing** system (COB) is a cluster formed from three IT platforms: **Customer DataBase** (CDB) **Intercarrier Billing Information System** (IBIS) and the **Call Details Records Flow** (CDRFLOW). Billing data is a sensitive matter for both customers and Proximus and requires real-time redundancy. Therefore, COB applications are hosted on dedicated technology: Tandem servers also called “Non-stop servers”. The CDB Application is retail related, IBIS wholesale related and CDRFLOW applies to both.

- **2537 Appl SW SAP**

The SAP Asset pools all costs coming from all modules used by Proximus. It is a typical business overhead costs.

- **2538 APPL SW-Number Portability**

Number Portability is composed of two main applications called **Fixed Number Portability** (FNP) and **Carrier Pre-Selection** (CPS). CPS is an important system as it is an interface with OLO’s requirements to deliver their services.

- **2539 Applic. SW ECA/ECM/VORTAL**

E-Channel Applications (ECA) and **E-Content Management** (ECM) are tools to manage and web-enable digital content for consumers (B2C) or enterprises (B2E). These are websites to engage customer relationship in order to conduct e-business via the Proximus websites.

- **2540 APPL SW – ROSY**

ROSY is a core component of the IT infrastructure as it is the runtime engine for SDH, XDSL and IDTV provisioning and repair.

- **2541 APPL SW – NETCAM**

NETCAM is a dedicated asset for Rosy's workflow engine for SDH (BPEL). This asset is purely network related and is not allocated to the IT Software and Hardware module. Instead it follows the network allocation stream through the CP2 module.

- **2542 Sales Handling Engine(SHE)**

The **Sales Handling Engine (SHE)** is a sales application used as a layer in order to enable convergence between all selling applications so that our vendors and partners will have a global view on all products supplied by Proximus, improving order intake and rationalizing the IT selling infrastructure. Pre-Sales and Sales are activities in the fulfillment process being mostly allocated to the residual market.

- **2544 APPL SW -IT Security**

IT Security asset pools heterogeneous costs that can be related to applications NFM (New Fraud Management), Proximus IT security in general, IMS (Identify and authenticate for provisioning engine) to protect user's privacy or overhead costs to protect the IT infrastructure from malicious harm (virus, hackers take-over...)

- **2547 Major software applications**

Major software applications are assets regrouping all new IT developments and applications since 2010.

- **2550 APPL SW ABC**

The **Access Backbone Connectivity** asset (ABC) is a core element of Proximus's infrastructure. SRW is an inventory for connectivity and equipment documentation and is used as an interface between IDMS and front-office applications such as OMS, WFM or COB/CDB. Three other core domains are also pooled in this asset: ABR³ for the local loop connectivity and managing resources and services. ANA⁴ (**A**utomated **N**umber **A**ssignment) supports service order provisioning of phone numbers through automation of the attribution of a phone number to a customer. Finally, ITR⁵ (**I**nfrastructure **T**Ransmission) is the inventory of Proximus's backbone and optical network covering leased lines, physical equipment, trails, trunks, cables and the multiplexing hierarchy between all these elements. It should be noted that applications grouped in this asset use a special hardware in order to run

properly as they are all linked to huge databases that require daily processing of data per batches. For the last years, BS2000 mainframes from Fujitsu were used but they were recently replaced by Z-Series from IBM⁶.

- **2551 Operational Inventories**

Operational Inventories are applications used to maintain ATM, DSLAM, Ethernet and IP inventories and statistics.

- **2552 GraphDoc**

The Graphdoc asset pools all graphical documentation components which are tools used to create or modify the local loop network documentation. It allows an integration of the Autocad package which is a drawing software.

- **2561 APPL SW – NETCOOL**

Netcool is a software package sold by IBM and developed internally to suit Proximus needs. It is a set of alarms and probes used for monitoring to ensure both a pro-active and reactive service assurance process. It is divided in two main domains: **Netcool Transmission (NCT)** and **Netcool Data (NCD)**.

- **2562 APPL SW - e-Health**

E-health is a reporting tool for bilan and is composed of e-health (A-EHT), Provisioning (A-PRO) which is an interface between e-health and umbrella/CMS and oblicore service layer (A-SLR).

- **2563 APPL SW-Customer Remote Support**

Applications used by the helpdesks or customers through the Proximus portal.

- **2566 APPL SW-DIAMON&CORRELATOR**

The diamond (DIA) and Correlator (CRL) asset regroup those two IT domains that enable the monitoring of network alarms. It also creates tickets to respond efficiently to problems.

- **2567 APPL SW – DARE**

DARE stands for **Diagnose Analyze Repair Engine** and is the main tool to analyze alarms and probes reports. It diagnoses problems through a root analysis, classifies incident by priority and forwards them to responsible persons for problem resolution.

- **2568 APPL SW-Learning & Mngt Syst.**

⁶ One IBM z10 Mainframe is supposedly 1500 times more powerful than regular x86 servers while consuming 85% less power (source IBM).

The learning management system asset is essentially a component of SAP HR (or SAP LMS for Learning Management System).

- **2569 APPL SW-ECRM**

The E-CRM asset contains one application named **Group Content Management (GCM)** which is a platform for contract, records and business process management.

- **2570 APPL SW Business Intelligence Tool**

All costs from the Microstrategy software are sent to the Business Intelligence Tool asset as the main software used by our business intelligence department (which is the Data Warehouse: DWH). It is heavily related to data warehouse and will be grouped with it so that the tools they use are represented in the total cost of the data warehouse.

- **2571 APPL SW ONE-Catalog**

The **Proximus Product Catalog** is an application that stores advice and information about all products and services. It is heavily used by Proximus Sales divisions and as a service assurance tool for customer care.

- **2573 Appl SW DWH**

The data warehouse department has heavy requirements in terms of hardware and software as it calculates statistics and indicators for Proximus products and network. Data warehouse uses a special hardware from the Teradata technology that helps with the treatment of large data volumes with the possibility for many users to analyze them.

Operational Costs:

There are various sources of IT opex costs:

A) Maintenance related:

Maintenance costs are regrouped into 2 different cost pools (G/L 61120 and 61130, respectively IT hardware & IT software) and are now directly allocated to the IT_Software & Hardware module (IT_SW_HW) "IT_Development_Infrastructure_Operations".

B) OPEX Wages internal

Internal wages for IT OPEX costs were allocated by the use of the RAPID database. A report by cost centers giving a detailed output of OPEX projects was linked to the cost centers groups from the cost base allowing an allocation from all IT teams to the IT Software & Hardware module.

Opex internal wages of ITS teams are now directly allocated to "IT_SW_HW – IT_Development_Infrastructure_Operations".

C) OPEX Contractors Bodyshopping and Fixed price:

Bodyshoppers and fixed prices contractors are separated from internal employees and transiting via the new module as of the 2018 model (Externals) before being allocated to the respective teams in the Technology module.

Opex contractors bodyshopping and fixed price costs of ITS teams are then directly allocated to “IT_SW_HW – IT_Development_Infrastructure_Operations”.

6.1.4 IT Software and Hardware to Markets

Since 2016, a new methodology is used to allocate IT costs: they are all pooled together based on the principle explained beforehand and are allocated to the end objects contained in the Market module based on the total costs per related object.

7 Network stream

The network allocation stream is organized around the network investment structure (leading to network functional blocks in the allocation stream). The focus is on Capital Expenditure costs which are directly associated with the network equipment deployed ; these costs originate from the assets accounting system of Proximus and they are gradually cascaded by means of a variety of cost deaggregation keys and a variety of cost drivers up to the telecommunication services. By contrast, the SRW stream focuses on the operating expenditures of the business activities, which are directly allocated to end- markets by means of business drivers.

For the operating costs of the network itself however, an intermediate allocation approach is used : the remuneration costs and the personnel related OPEX costs are associated to typical network activities (as described in Chapter 5) which are finally attributed to network functional blocks . This part is discussed in section 7.3 hereafter.

7.1 A layered allocation model

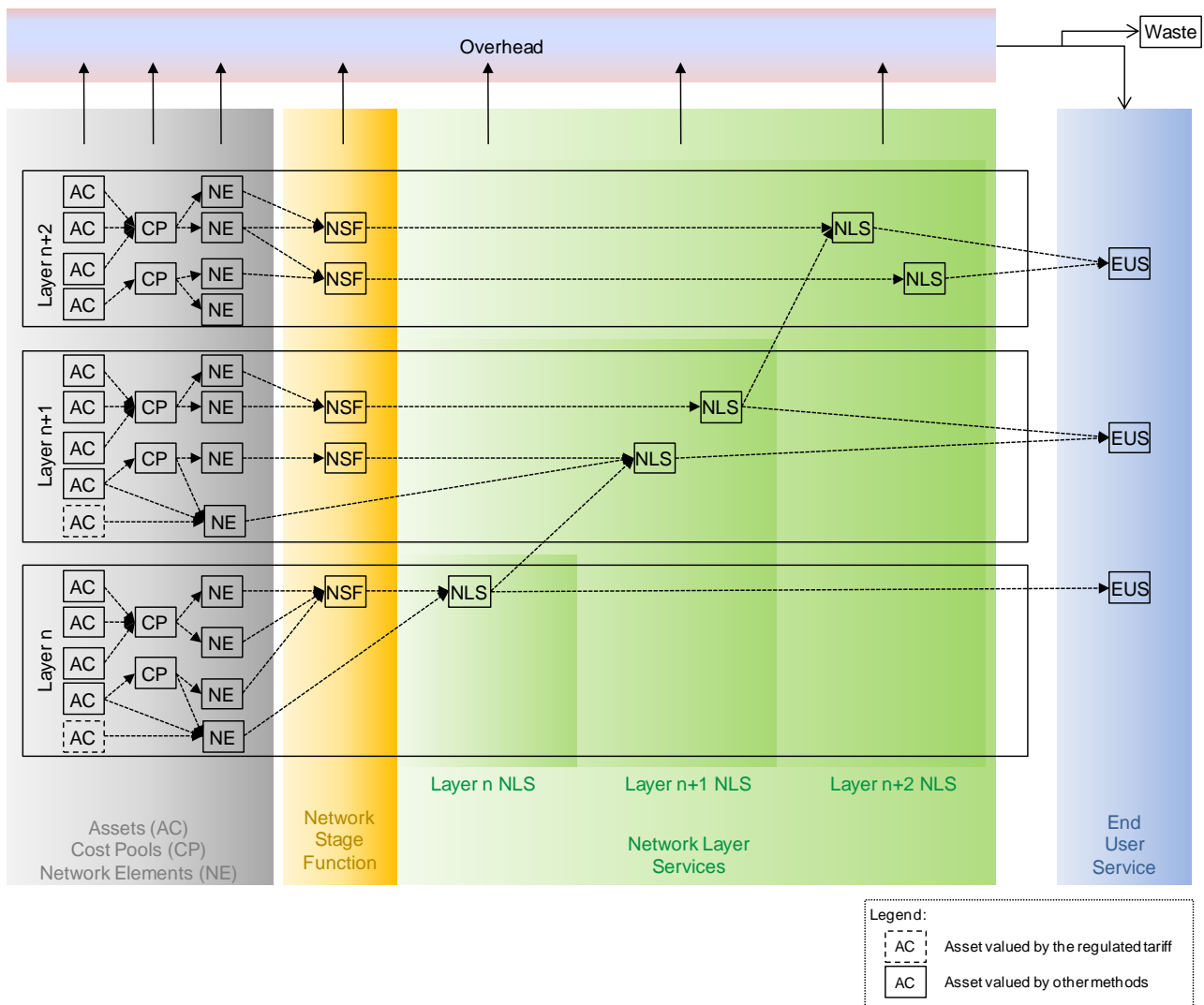

Figure 4: Layered allocation model

It is common practice in the telecommunication industry to separate investments in different logical levels; lower levels corresponding to basic (simple and general purpose) services, higher levels corresponding to complex higher valued and purpose oriented services. The pursued effect of such separation is to promote the reuse of basic lower level services by higher level services thereby bringing in the short term the volumes at each layer to levels that benefit from economies of scale. In the long term, the pursued effect is to benefit also from economies of scope.

The network cost allocation model is designed to reflect the layered functional structure of Proximus’s telecommunication infrastructure , each layer offering services to the upper layers. In practice 5 layer levels are represented in the cost allocation model in order to allow each invested technology to be situated at the right level of its contribution in implementing the layer services.

In practice a network equipment may participate to several different layers especially in the interfacing boards towards other network equipment because it acts as a terminating point of lower level layer services.

To avoid any ambiguity, a network equipment will be considered as belonging to the highest layer implemented in it and operated by it. For the example of the IP router, this simple criterium locates an IP router on the third layer (IP layer) above SDH.

Using this criterium all investments still in service of Proximus's infrastructure are distributed in one of the following layers:

Layer NLS1.0 : Passive infrastructure gathering investments in access copper, in ducts and fibre cables (access and backbone).

Layer NLS2.0 : Active transmission infrastructure based on Time Division Multiplexing technology gathering investments in PDH, SDH.

Layer NLS2.1 : Active data infrastructure based on Packet Based technology gathering investments in Ethernet/MPLS.

Layer NLS2.2 : Mobile backhauling infrastructure

Layer NLS3 : Active data infrastructure based on IP technology gathering IP routers , IPVPN routers.

Layer NLS4.0 : Active application infrastructure based on a variety of technologies gathering applicative equipment like telephony digital switches, VoIP platforms, Intelligent Network platforms, Broadcast TV platforms, Video on Demand platforms.

In the model layers are represented by a number of “standard” services (referred to in the sequel as Network Layer Services – NLS) offered to upper layers or directly used as retail/wholesale products (End User Services – EUS). In turn the services offered by a layer are the result of the combination of layer specific functions (referred to as Network Stage functions – NSF)* and services offered by lower level layers allowing the layer specific functions to interact with each other.

*Note: Except the following Network Elements that receive assets cost valued by the regulated tariff. Those Network Elements include network stage functionality and directly offer services of the same level as their upper layer services. The driver used is “yearly direct CAPEX cost”. The driver “yearly direct CAPEX cost” is in fact a by-product of the valuation exercise done for the assets valued by the regulated BIPT tariff.

For the asset valuation exercise a full integration of all the asset valuation components of the relevant technology was necessary (see paragraph **Error! Reference source not found.**), but in the case of the calculation of this driver the required aggregation degree is determined by the allocation key to be calculated.

The inventories used as input for the asset valuation contain many details allowing the grouping of the costs components based on any combination of such aspects.

Therefore, the driver “yearly direct CAPEX cost” refers to the sum of all the relevant technology valuation components from the appropriate models that meet the allocation requirements (for example, usage of the link or bandwidth or bandwidth and service span or concerned network layer...).

Due to the method used for the valuation of the SDH, the “yearly direct CAPEX cost” allocation driver for the NE_PDH SDH equipment can't be calculated as referred above. Instead it is calculated as the incremental SDH cost of the service for which the allocation is being computed.

Incremental costs of one service are those costs that are avoided by not providing that service. See Figure 5 for an example specific to this context, where:

- the cost incurred by all the SDH services equals the SDH asset value, resulting from running the “consolidated transport BROTSOLL engine” (see paragraph **Error! Reference source not found.**) with the full set of services carried over SDH
- the cost incurred by an SDH network carrying all the SDH services except service X is the outcome of the dimensioning and costing done by the “consolidated transport BROTSOLL engine” when having as input all the SDH services but service X.
- the SDH incremental cost for service X is calculated as the difference between the two above costs

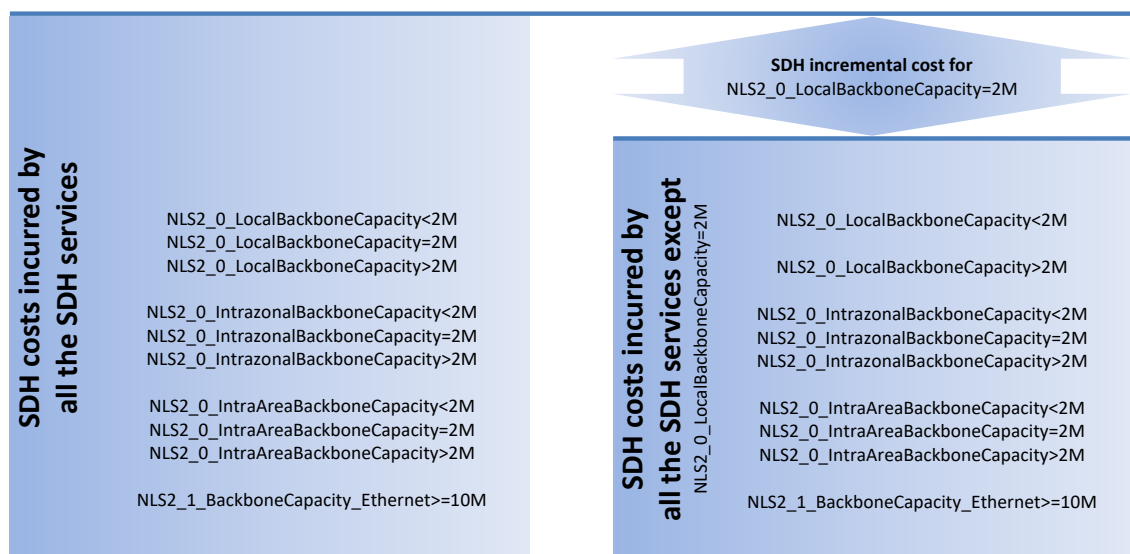

Figure 5: Incremental SDH costs calculation method, an example

NE receiving assets by the regulated tariff	offered services
NE_ADSL equipment	NLS2_1_xDSL_Bitstream
NE_NGA Active equipment	NLS2_1_xDSL_Bitstream
NE_NGA Housing	NLS2_1_xDSL_Bitstream
NE_PDH SDH equipment	NLS2_1_LocalTailCapacity_Ethernet>=10M
	NLS2_1_BackboneCapacity_Ethernet>=10M
	NLS2_0_IntraAreaBackboneCapacity<2M
	NLS2_0_IntraAreaBackboneCapacity=2M
	NLS2_0_IntraAreaBackboneCapacity>2M
	NLS2_0_IntrazonalBackboneCapacity<2M
	NLS2_0_IntrazonalBackboneCapacity=2M

	NLS2_0_LocalBackboneCapacity<2M
	NLS2_0_IntrazonalBackboneCapacity>2M
	NLS2_0_LocalBackboneCapacity>2M
	NLS2_0_LocalBackboneCapacity=2M
	NLS2_0_LocalTail=2M
	NLS2_0_LocalTail<2M
	NLS2_0_LocalTail>2M
NE_Copper_Cables_Distribution	NLS1_0_Copper_Subloop
	NLS1_0_Raw_Copper
NE_Copper_Cables_Feeding	NLS1_0_Raw_Copper
NE_Copper_Blocks_and_Tie_Cables	NLS1_0_Continue_Raw_Copper
	NLS1_0_Copper_Localloop_testing
	NLS1_0_Copper_Subloop_testing
NE_Copper_Splitter	NLS1_0_Copper_Splitter

The use of BIPT Fixed voice NGN cost model enables to define the network element cost attribution to the underlying network stage function per asset category

NE receiving assets by the Fixed voice NGN cost model	attribution
NE_OwnNetwork_CallHandling	NSF_OwnNetwork_CallHandling
NE_Interconnecting_CallHandling	NSF_Interconnecting_CallHandling
NE_Voice_o_Broadband_SBC	NSF_Voice_o_Broadband_SBC
NE_VoiceIP_Router	NSF_VoiceIP_Router
NE_VoiceTrunks_TDM	NSF_VoiceTrunks_TDM
NE_VoiceTrunks_IP	NSF_VoiceTrunks_IP
NE_IP_Voice_Concentrator	NSF_PSTN_Voice_concentrator

Layer n--layer n+1 cost allocation mechanism:

Each layer represented in the model produces the defined NLS services with a certain amount of volume (the service amount); this amount is “consumed” by the upper layer services and it is used as a driver to allocate the costs to the consumer services in the upper layers.

Layer cost allocation cascade:

The 5 defined layers are put one after another according to their level generating a cascade of cost allocation mechanism.

Each layer is discussed in a specific chapter of this documentation.

Establishing costs of the Network Stage Functions

The “network stage functions” (NSF) are the direct constituents of a layer, they are intermediate network building blocks providing well defined logical network functions specific to that layer (also called network functional units) . A Network Stage Function can be limited to a node or it can be a cluster (distributed function) corresponding to “network stages”. A network stage function is characterized by the amount of function it produces (volume).

Network Stage Functions are implemented in equipment, but the corresponding investment values are not always directly identifiable in the asset structure of Proximus : for example some assets aggregate investments per technology (not per function in the network) , some other do not cover the totality of a given technology due to the history of the accounting asset structure in SAP (reorganization of assets, transfers between assets, closing of asset classes and opening of new ones)

Different methods are used and combined to constitute the investment costs of Network Stage Functions :

1. Aggregation of assets in a larger asset or a cost pool in order to gather investments of same technology and align them with operational inventories.
2. Deaggregation of cost pools in network elements : this step decomposes cost pools into network elements; a network element corresponds to an entire physical equipment as deployed in the Proximus infrastructure. Operational inventories of pieces of equipment and component prices are used.
3. Direct allocation of assets or cost pools to network elements when the assets or cost pools are directly identifiable with a network element of the model.
4. Composition of the network elements to form a network stage function covering one of the stages.

The stepwise combination of these methods are discussed in the next section.

7.2 From Assets to Network Stage Functions.

Next table gives the list of the NSF present in the network allocation flow.

Layer_name	NSF_name	NSF description
L1_PASSIVE	NSF_Backbone_FibreConnectivity_express	backbone fibre connectivity of express ring
	NSF_Backbone_FibreConnectivity_Regional&Core	backbone fibre connectivity of regional&Core rings
	NSF_FTTC_FibreConnectivity	fibre connectivity between the central office (LEX) and ROP
	NSF_FTTO_FibreConnectivity	fibre connectivity between the central office (LEX) and customer office
L3_IP	NSF_BroadBand_Public_IP_Collect	Access authentication , data traffic accounting, attribution of public IP address to broadband customers and collection of customer traffic towards public internet service providers

	NSF_BroadBand_VoD_IP_Collect	Access authentication , data traffic accounting, attribution of IP TV address to IP TV customers and collection of IP video customer traffic towards Video On Demand platforms
	NSF_BroadBand_VoIP_IP_Collect	Access authentication , data traffic accounting, attribution of Voice over IP address to VoIP customers and collection of Voice over IP customer traffic towards VoIP platforms
	NSF_Dedicated_Access_to_PrivateIP	connectivity between customer and Proximus IP-VPN network
	NSF_Homegateway	Broadband CPE like b-box
	NSF_IP_security	
	NSF_PrivateIPSwitching	IP-VPN switching
	NSF_PublicInternetSwitching	Public Internet Routing
	NSF_Mobile_RAN_Data	Mobile Radio Access function destined to all Mobile data products
	NSF_Mobile_BackBone-Data	Mobile backbone function destined to all Mobile data products
	NSF_Mobile_PrepaidData_Services	Intelligent platform services related to prepaid mobile data
L4_IDTV	NSF_BroadcastTV	Broadcast digital television functionalities
	NSF_VoD	Video On Demand (VOD) functionalities and user quality of experience functionalities.
L4_M2M	NSF_Machine_to_Machine	Related to M2M applications, enabling customers to remotely manage their M2M devices in the cloud or gather business data from the devices and to integrate and link it with business softwares.
L4_VOICE	NSF_Automated_call_distribution	intelligent distribution of calls towards call center
	NSF_Advanced_Number_Translation_CallHandling	Voice Value Added network function
	NSF_Advanced_CallHandling	Voice Value Added network function
	NSF_ISDN_NetworkTermination	Functionalities related to the ISDN network termination equipment
	NSF_Mobile_RAN_Voice	Mobile Radio Access function destined to all Mobile voice products
	NSF_Mobile_BackBone-Voice	Mobile backbone function destined to all Mobile voice products
	NSF_Private_Communication_Call_Handling	Intelligent platform service related to mobile closed user groups and virtual private networks
	NSF_Mobile_Traffic_Services	Intelligent platform services related to mobile voice traffic
	NSF_SMS_Services	Intelligent platform services related to mobile SMS traffic
	NSF_Mobile_Data_Services	Intelligent platform services related to mobile data traffic
	NSF_PairGainSystem	Analog line multiplexing functions, used to concentrate narrow band analog signals on customer pairs to

		a 2Mb/s digital signal on a few feeding copper pairs. This is however an old technology not compatible with broadband.
	NSF_PSTN_Voice_concentrator	Aggregation of PSTN voice calls towards NGN IP Platform
	NSF_Voice_call_CAE_charging	generation of call detail records for interoperator voice traffic accounting
	NSF_Voice_call_CAE_Processing	handling of voice calls at transit level
	NSF_Voice_call_CAE_Trunks	multiplexing/demultiplexing voice circuits at transit level
	NSF_VoiceTrunks_TDM	multiplexing/demultiplexing voice circuits generated/terminated
	NSF_VoiceTrunks_IP	multiplexing/demultiplexing voice circuits generated/terminated
	NSF_Voicemail&Messaging	Voice Value Added network function destined to residential customers
L4_Messaging	NSF_Mobile_RAN_SMS	Mobile Radio Access function destined to all Mobile SMS products
	NSF_Mobile_BackBone-SMS	Mobile backbone function destined to all Mobile SMS products
	NSF_SMS_Services	Intelligent platform service related to mobile SMS
L4_WEB	NSF_EServices	NSF gathering SDE workload related to the E-services.

Investment costs of Proximus SA assets are mapped to these NSF, except investments related with network administration, and some other that cannot be related to any current product or service. The exceptions are not filed into the network allocation cascade, but are allocated like an overhead cost (i.e. with no direct causality) to a range of End User Services (depending on the kind of overhead cost) proportionally to the cascaded costs on these EUS.

Mapping AC2 objects to cost pools or Network elements

AC2 Aggregation.

At this stage, AC2 asset objects are aggregated into cost pools, network elements, overhead objects and eventually end user services (costs marginal end user services, or direct waste).

The aggregations into cost pools serve to form technology pools for which operational inventories can be queried for various statistics that are further used to decompose into network elements. The technology pools typically are (D)WDM equipment, Copper Cables, Broadband (xDSL) equipment, SDH equipment, PDH equipment, Ethernet equipment etc. Those cost pools include also the OPEX of SDE.

The aggregation into network elements concerns assets that are already a network element, and it serves also to gather assets that are individually more detailed than the definition of network

elements and that can be easily associated to a network element. Typical examples are IP-VPN assets , broadcast TV assets, Analog Multiplexers etc.

AC2 Deaggregation.

By contrast, a set of AC2 assets are decomposed (deaggregated) into cost pools, Network elements, waste pool and marginal end user services.

Among these, some assets collect investments on network administration (Hardware and software supervision platforms) and on value added services platforms (IN, messaging, voice mail etc.): they need to be decomposed into the network technologies they supervise and into the value added service categories.

⇒ The driver used is the “cumulatedInvestedAmount” per technology obtained after deep analysis of historical investment data (TM1 financial reporting tool).

The asset 1680 “TPT-BBN-infra.elect/mécan in transmis rooms” collects internal cabling within technical buildings and is decomposed essentially into the following cost pools CP_Backbone_Coax_cabling, CP_Backbone_Optical_cabling, CP_(D)WDM_equipment and EUS_notAllocated (internal cabling of xDSL, switching and AGW equipments in LEX included in assets valued using the Proximus Reference Offer tariffs).

⇒ The driver used is the “Current annualized cost” of the cost pools , calculated from a diversity of constituent volumes and corresponding prices (coax/fibre cables, connectors, copper pair cables , cable ways,etc) . The main volumes are extracted from the infrastructure inventory database (ITR), other volumes are derived under assumptions.

The AC2_TDM_VoiceSwitching_Equipment asset is considered as fully outphased and replaced by MEA AC2_20115 ConvergentVoice_NGN_Platform. This asset is valued based on BIPT Fixed Voice NGN platform cost model.

Deaggregation of cost pools into network elements

In performing the previous steps cost pools are introduced in the model. They are now deaggregated into different Network Elements by means of following drivers:

cost pool	driver name	Deaggregated Network elements
CP_(D)WDM_equipment	Yearly Direct CAPEX Cost	regional&core DWDM network elements and express DWDM network elements
CP_Backbone_Optical_cabling	Nbr_Connections	pre-allocated to all inside network elements using fibre cabling
CP_Backbone_Coax_cabling	Nbr_Connections	pre-allocated to all inside network elements using coax cabling
CP_Copper_Burried_Cables&Splices	yearly direct CAPEX cost	distribution cables, feeding cables network
CP_DSLAM	yearly direct CAPEX cost	xDSL ATM based network elements and VDSL Ethernet based network elements
CP_Ducts&Manholes	Trenches cumulated length (km)	Ducts& manholes for Next Generation Access, Ducts & manholes for corporate/complex nodes in access
CP_EthernetMPLS_equipment	Yearly Direct CAPEX Cost	Ethernet Ports, Ethernet/MPLS switches
CP_Optical_Fibre_Cables	kmxfibre	Fibre cables for Next Generation Access, Fibre cables for corporate/complex nodes in access
CP_OSS_VoiceTraffic	fair split	Collecting, terminating and transit of voice network elements
CP_SDH	Yearly Incremental Cost	
CP_Mobile_RAN	Yearly capitalized manpower cost	Mobile Radio Access network, Ground antenna
CP_Mobile_Backbone	fair split	Mobile Voice and Data switching elements

From Network elements to Network Stage Functions

The previous steps populate the cost model with Network Elements. In the next step, they are allocated to the Network Stage Functions.

7.3 End User Services

The network allocation model terminates when all network stage functions (or NEs) have been allocated to network layer services and when network layer services have been combined into a user level telecommunication service, the End User Service.

The End User must be understood as the telecommunication service party that will pay for the service. In case of a retail service the user is identical to the service consumer (residential service) or to the service provider (business service) , in case of wholesale service , the user is in principle another licensed operator , or a network service provider.

Being composed of network layer services, End User Services may emanate from different levels of network layers since interconnection between network operators is being unbundled . For retail services , the end user telecommunication services may arise from different layers : the more a service is oriented for a specific usage the higher the level of network layers involved. For example IP services are less usage oriented than voice telephony, the latter being a layer 4 service, the former a layer 3 service.

The End User Services represented in the model are listed hereunder.

End User Service Layer	Market	End User Service Name
L1_passive	InterConnect	EUS_Raw copper subscription
		EUS_Shared pair subscription
L2_packetBased	InterConnect	EUS_BROBA_EndUserLine subscription
		EUS_wholesale transport WBA subscription
	retail	EUS_X25
L2_TDM	Retail&Wholesale	EUS_Ethernet_Backhaul
	InterConnect	EUS_BROTSOLL_segment<2M
		EUS_BROTSOLL_segment>2M
		EUS_BROTSOLL_segment2M
	Retail&Wholesale	EUS_LL <2M subscription - International
		EUS_LL <2M subscription - National
		EUS_LL >2M subscription- National
		EUS_LL >2M subscription - International
		EUS_LL 2M subscription - International
		EUS_LL 2M subscription - National
	Wholesale	EUS_LL_Analog National Subscription - National
		EUS_Nat IC-Infra Wholesale subscription
L2_TDM&L1_ActiveAnalog	Retail&Wholesale	EUS_Trans LAN subscription
L3_IP	retail	EUS_BGC Mobile_Roaming Out data
		EUS_Homegateway
		EUS_Mobile_Data national
	Retail&Wholesale	EUS_DataManagedServices
		EUS_FastInternet subscription
		EUS_Private_IP&Ethernet_on_asymmetric subscription - National
		EUS_Private_IP&Ethernet_on_backup
		EUS_Private_IP&Ethernet_on_international Subscription

		EUS_Private_IP&Ethernet_on_symmetric_HighEnd Subscription - National
		EUS_Private_IP&Ethernet_on_symmetric_lowEnd Subscription - National
	Wholesale	EUS_ADSL_Carrier_wholesale subscription
		EUS_Mobile_Roaming_IN_Data
		EUS_VDSL_Carrier_wholesale subscription
L4_iDTV	retail	EUS_IDTV_subscription
L4_M2M	retail	EUS_Machine_to_Machine
L4_messaging	InterConnect	EUS_SMS_inbound_intal
		EUS_SMS_inbound_national
	retail	EUS_SMS_on_net_national
		EUS_SMS_outbound_intal
		EUS_SMS_outbound_national
		EUS_SMS_Roaming_OUT_Origination
		EUS_SMS_Roaming_OUT_Termination
	Wholesale	EUS_SMS_Roaming_IN_Origination
		EUS_SMS_Roaming_IN_Termination
L4_voice	all	EUS_AUTOMATEDCALLDISTRIBUTION
	InterConnect	EUS_Carrier PreSelection
		EUS_voice_traffic_Fixed_inbound_intal
		EUS_voice_traffic_Fixed_inbound_intal_VAS
		EUS_voice_traffic_Fixed_inbound_national
		EUS_voice_traffic_Fixed_inbound_VAS_national
		EUS_voice_traffic_Mobile_inbound_intal
		EUS_voice_traffic_Mobile_inbound_intal_VAS
		EUS_voice_traffic_Mobile_inbound_national_from FOLO
		EUS_voice_traffic_Mobile_inbound_national_from MOLO
		EUS_voice_traffic_Mobile_inbound_VAS_national
	Retail&wholesale	EUS_Astrid
		EUS_voice_traffic_Fixed_on_net_national
		EUS_voice_traffic_Fixed_on_net_to Mobile_national
		EUS_voice_traffic_Fixed_on_net_VAS_national
		EUS_voice_traffic_Fixed_outbound_intal
		EUS_voice_traffic_Fixed_outbound_intal_VAS
		EUS_voice_traffic_Fixed_outbound_national_to FOLO
		EUS_voice_traffic_Fixed_outbound_national_to MOLO
		EUS_voice_traffic_Fixed_outbound_VAS_national
		EUS_voice_traffic_Fixed_transit_intal
		EUS_voice_traffic_Fixed_transit_national
		EUS_voice_traffic_Mobile_on_net_to Fixed
		EUS_voice_traffic_Mobile_on_net_to Mobile
		EUS_voice_traffic_Mobile_on_net_VAS_national
		EUS_voice_traffic_Mobile_outbound_intal
		EUS_voice_traffic_Mobile_outbound_intal_VAS
		EUS_voice_traffic_Mobile_outbound_national_to FOLO
		EUS_voice_traffic_Mobile_outbound_to MOLO

		EUS_voice_traffic_Mobile_outbound_VAS_national
		EUS_voice_traffic_OPS
	Retail&Wholesale	EUS_Voice_one_channel
		EUS_Voice_multichannels
	Retail&Wholesale	EUS_voice_traffic_Mobile_Roaming_IN_Origination
		EUS_voice_traffic_Mobile_Roaming_IN_Termination
		EUS_voice_traffic_Mobile_Roaming_out_Origination
		EUS_voice_traffic_Mobile_Roaming_out_Termination
L4_Web	retail	EUS_Eservices

Copper Termination

The network element Copper Termination groups costs related to fieldwork performed in the copper access network in order to realise broadband connections for end-users. These activities are mainly situated at the MDF, SC and the introduction up to the Network Termination Point (included).

7.4 Network services of the passive infrastructure layer : NLS1.0

7.4.1 Definition

This layer deals with the physical end-to-end connectivity between customers and the central sites (access), the physical connectivity inside the central site between access equipment and the physical connectivity between central sites (backbone).

Access Physical connectivity services (see Figure 6):

- NLS1_o_Continue_Raw_Copper : internal cabling for copper connectivity from Main Distribution Frame or broadband splitter equipment to other access active equipment like voice switches, leased lines access equipment, collocated access equipment (of other licensed operators).
- NLS1_o_Copper_Localloop_testing : inside copper connectivity and equipment required to perform remote testing of the copper loop.
- NLS1_o_Copper_Splitter : resources to split the narrowband and broadband copper physical signal.
- NLS1_o_Copper_Subloop : end-to-end copper connectivity from the network termination point at the customer premises to a delivery point in the street (street cabinet).
- NLS1_o_Copper_Subloop_testing : inside copper connectivity and equipment required to perform remote testing of the copper subloop.
- NLS1_o_Raw_Copper : end-to-end copper connectivity from the network termination point at the customer premises to the Central site.

- NLS1_o_CentralOffice2Office_Duct : end-to-end underground hole connectivity (duct routes in trenches) between the central sites and corporate customers office buildings .
- NLS1_o_CentralOffice2Office_Fibre : end-to-end fibre connectivity between the central sites and corporate customers office buildings or between central sites and Proximus mobile sites.
- NLS1_o_CentralOffice2RemoteOpticalNode_Duct : end-to-end underground hole connectivity (duct routes in trenches) between the central sites and the Proximus subtended optical nodes and Proximus optical nodes at street cabinet level.
- NLS1_o_CentralOffice2RemoteOpticalNode_Fibre : end-to-end fibre connectivity between the central sites and the Proximus subtended optical nodes and Proximus optical nodes at street cabinet level.

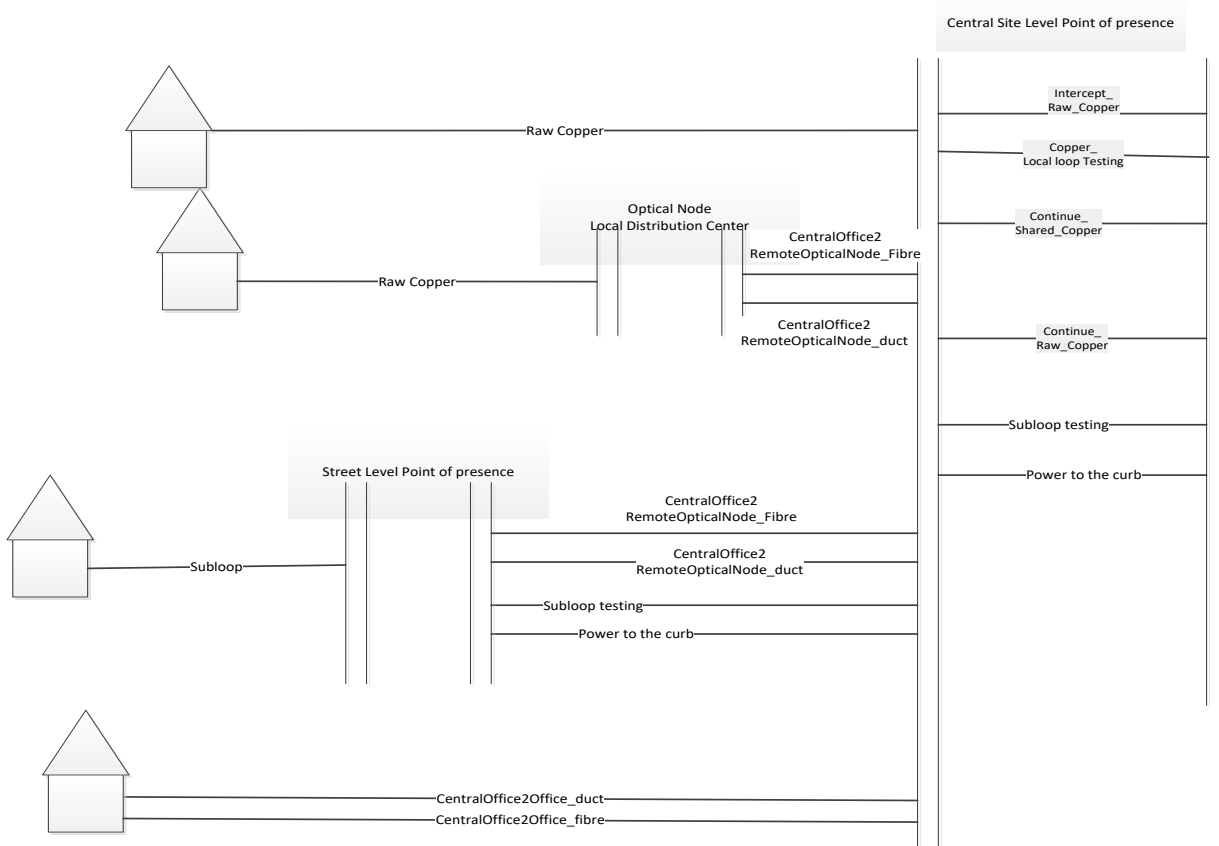

Figure 6: Access Physical connectivity services

Backbone Physical connectivity services

- NLS1_o_Fibre_connect_Backbone_SDH_Regional&Core: end-to end fibre connectivity (fibre cables and duct and trenches) for SDH transmission networking between nodes belonging to the regional and core backbone (WAN) network. These nodes are central offices at local level, zonal level.

- NLS1_0_Fibre_connect_Backbone_DWDM_Regional&Core : end-to end fibre connectivity (fibre cables and duct and trenches) for DWDM optical networking between nodes belonging to the regional and core backbone (WAN) network. These nodes are central offices at local level, zonal level.
- NLS1_0_Fibre_connect_Backbone_DWDM_Express : end-to end fibre connectivity (fibre cables and duct and trenches) for DWDM optical networking between nodes belonging to the express (national level) network. These nodes correspond to the largest cities in the country.

7.4.2 Usage of the passive infrastructure

The physical connectivity services of this layer are used by upper layers in order to interconnect their specific equipment. The costs are distributed to the service users according to “consumption drivers” as listed in the table below.

Network layer Service	Driver	Service consumers
NLS1_0_Continue_Raw_Copper	Nbr_of_used_pairs	BRUO raw copper, Local tails for leased linetype of connectivity, ISDN/PSTN accesses, BRUO Shared Pairs
NLS1_0_Copper_Localloop_testing	nbr of lex based broadband connections without voice	Broadband bitstream layer 2.1 services
NLS1_0_Copper_Splitter	Nbr of used shared pairs	BRUO Shared pairs
NLS1_0_Copper_Subloop	Direct	VDSL bistream layer 2.1 service
NLS1_0_Copper_Subloop_testing	Nbr of used pairs	VDSL bistream layer 2.1 service
NLS1_0_Raw_Copper	Nbr_of_used_pairs	BRUO raw copper, Local tails for leased linetype of connectivity, ISDN/PSTN accesses, Broadband Bitstream layer 2.1 service
NLS1_0_CentralOffice2RemoteOptical Node_Duct	Number of physical sites	Local tails services of layer 2.0 (for leased lines), of layer 2.1 (Ethernet local tails).
NLS1_0_CentralOffice2RemoteOptical Node_Fibre	Nb_access_fibres_used	
NLS1_0_CentralOffice2Office_Duct	Number of physical sites	Local tails services of layer 2.0 (for leased lines), of layer 2.1 (Ethernet local tails).
NLS1_0_CentralOffice2Office_Fibre	Nb_access_fibres_used	
NLS1_0_Fibre_connect_Backbone_SDH_Regional&Core	generic (CAPEX costs from PDH SDH MWE Technology)	Backbone services (leased lines/backhaul and Broadcast) delivered by the SDH equipment at regional and core level.
NLS1_0_Fibre_connect_Backbone_DWDM_Regional&Core	generic (CAPEX costs from NE_(D)WDM equipment)	Regional&Core backbone services of layer 2.1 (Ethernet transport, unicast and multicast)
NLS1_0_Fibre_connect_Backbone_DWDM_Express	generic (CAPEX costs from NE_Express_DWDM_equipment)	Express backbone services of layer 2.0 (leased lines) and layer 2.1 (Ethernet)

7.4.3 Contributors to the passive infrastructure layer

7.4.3.1 Access

The objective of the access network is the delivery of a connection between our customers and our telecommunication network where all services are implemented.

Copper infrastructure:

The access network services of the copper passive infrastructure layer are based on several network elements valued using the BIPT regulated cost price, as listed below. For these network elements, there is no change in the valuation methodology compared to previous model. As in the previous models, the former network element NE_Copper infrastructure has been split in several subparts, in order to enable the fix/variable analysis of the model results .

- ✓ NE_Copper_Cables_Distribution
copper distribution pairs and access to distribution pairs in street
- ✓ NE_Copper_Cables_Feeding
copper feeding pairs and access to feeding pairs in street and central site
- ✓ NE_Copper_Blocks_and_Tie_cables
copper local loop testing for broadband customer connections without voice at the central site,
copper subloop testing for ROP based VDSL customer connections without voice,
continue copper feeding pairs based on the number of shared pairs in service,
continue raw copper for all other copper pairs in use.
- ✓ NE_Copper Splitter
For the BRUO shared pairs in service.

NSF_PSTN_Voice_concentrator:

Attributed to :

- copper local loop testing based on the number of broadband without voice customers connections at the central site,
- copper subloop testing for VDSL without voice customer connections at the street cabinet,
- PSTN Access based on the number of subscriptions

Customer connections without voice are connected to the Access Gateway (AGW) equipments in order to perform remote testing of the line.

Access Fibre Infrastructure:

The costs of the fibre deployed in the access network have been separated in the civil works related costs producing duct routes, and in the cable related works producing fibre connectivity inside the duct routes. Civil work related costs and cable related costs are subject to different assets within Proximus's asset accounting and can easily be identified. These assets do not distinguish the investments realized for connection of customer sites, mobile sites or remote optical nodes (at subtending level and street cabinet level). Therefore two drivers are used :

1. Kmxfibre : to separate the fibre cable costs between customer/mobile sites and remote optical sites
2. Amount km routes to physical sites : to separate the civil works costs between customer/mobile sites and remote optical sites .

Yielding following objects :

NSF_CentralOffice2RemoteOpticalNode_FibreCables

NSF_CentralOffice2Office_FibreCables

NSF_CentralOffice2RemoteOpticalNode_Track

NSF_CentralOffice2Office_Track

7.4.3.2 **Backbone**

The backbone fibre connectivity services are realized by the following Network Stage Functions embodying the resources in the fibre outside plant (ducts&manholes, and fibre cables):

- NSF_Backbone_FibreConnectivity_Regional&Core
- NSF_Backbone_FibreConnectivity_express

NSF	Driver	NLS1_0
NSF_Backbone_FibreConnectivity_express	direct	NLS1_0_Fibre_connect_Backbone_DW DM_Express
NSF_Backbone_FibreConnectivity_Regional&Core	fair split of fixed cost	NLS1_0_Fibre_connect_Backbone_DW DM_Regional&Core NLS1_0_Fibre_connect_Backbone_SD H_Regional&Core

7.5 Network services of the transmission infrastructure (NLS2_o)

7.5.1 Definition

This layer deals with the transmission services between customer sites and the Proximus Offices (access) also called local tail for leased lines, and it deals also with the transport segments services (also called backbone leased lines segments and backhaul capacity) between Proximus Offices (backbone).

The national wide transmission infrastructure collects transmission traffic in three aggregation stages: local level aggregation (circ 600 locations), zonal level aggregation (circ 36 locations), area level aggregation (20 locations) (see Figure 7: Transport Segments). Traffic at each stage can be cross-connected allowing to create transport segments from any location to any location.

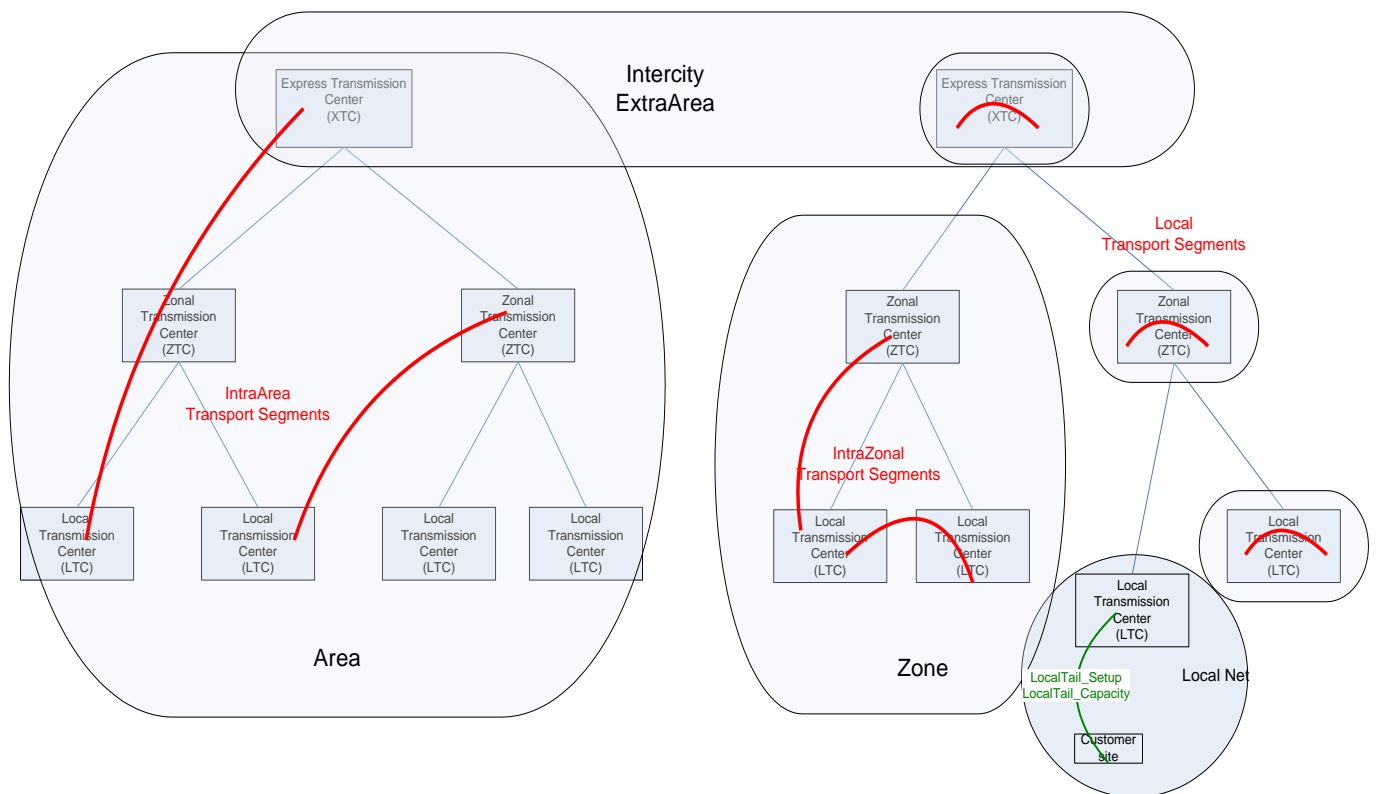

Figure 7: Transport Segments

Access services

The access services deliver the transmission between the customer site and the Proximus Office (access).

They capture costs related to the physical_dedicated link between the customer site and the central office and the equipment needed to activate the link in a capacity category.

Backbone services:

The backbone transport segments are classified in capacity (or bandwidth) categories -<2Mb/s, 2Mb/s, >2Mb/s- combined with distance categories -intraarea > intrazonal > local- depending on the end point situation in the aggregation hierarchy (see Figure 7).

The following NLS2.0 services are present in the model:

Network Layer 2.0 service
NLS2_0_LocalBackboneCapacity<2M
NLS2_0_LocalBackboneCapacity=2M
NLS2_0_LocalBackboneCapacity>2M
NLS2_0_IntrazonalBackboneCapacity<2M
NLS2_0_IntrazonalBackboneCapacity=2M
NLS2_0_IntrazonalBackboneCapacity>2M
NLS2_0_IntraAreaBackboneCapacity<2M
NLS2_0_IntraAreaBackboneCapacity=2M
NLS2_0_IntraAreaBackboneCapacity>2M
NLS2_0_InterCityBackboneCapacity<2M
NLS2_0_InterCityBackboneCapacity=2M
NLS2_0_InterCityBackboneCapacity>2M
NLS2_0_LocalTail<2M
NLS2_0_LocalTail=2M
NLS2_0_LocalTail>2M

7.5.2 Usage of the transmission infrastructure

The NLS2_0 Local tail services are used to bring transmission capacity to the customer sites and they are thus directly involved in leased line services between two customer sites, leased lines to data services, backhaul services to other licensed operators and monitoring of the access network.

The costs of these access services are distributed according to the number of customer sites per bandwidth category (driver name: “Nbr_of_Customer_sites”), whereas the backbone services costs are further allocated according to their bandwidth (driver name: “Bandwidth consumed (Mbit/s)”).

The model elements receiving costs from this network layer are exhaustively presented in the following table.

	Upper layer consumer or end user service
Backbone Virtual Paths (VP)	NLS2_1_Backbone_VirtualPath_InterArea
	NLS2_1_Backbone_VirtualPath_IntraArea
Proximus mobile	NLS2_2_Mobile_Access_Backhaul_Abis
	NLS4_0_BGC Mobile_Access_Collect_Voice
	NLS2_2_Mobile_Backbone_Backhaul
	NLS4_0_BGC MobileSwitchedVoice_transport_National_offnet

	NLS2_2_Mobile_Access_Backhaul_luB
	NLS4_0_MobileTerminatingLinks
Proximus testing environments	OVH_Lab
Broadband access to public IP switching	NLS3_xDSL_Public_IP_collection
Data services backbone (IP-VPN)	NLS3_Private_IP&Ethernet_Routing
Internal Proximus network	OVH_InternalCommunicationNetwork
	OVH_InternalIPNetwork
International access to data services (IP-VPN)	EUS_Private_IP&Ethernet_on_international Subscription
Leased line access to public IP switching	NLS3_Public_IP_Extension_on_symmetric
Leased line accesses to data services (IP-VPN)	NLS3_Private_IP&Ethernet_Extension_on_symmetric_HighEnd
	NLS3_Private_IP&Ethernet_Extension_on_symmetric_LowEnd
Other	Business Overhead
	EUS_DataManagedServices
	EUS_Subidiaries
Public IP switching	NLS3_Public_IP_switching
Regulated broadband services	EUS_BROBA_accessLine
	NLS2_1_ADSL_SDSL_Bitstream
Regulated wholesale segments	EUS_BROTSOLL_segment<2M
	EUS_BROTSOLL_segment>2M
	EUS_BROTSOLL_segment2M
Retail&Wholesale leased lines	EUS_international_switchingTrunk
	EUS_LL <2M subscription - International
	EUS_LL <2M subscription - National
	EUS_LL >2M subcription- National
	EUS_LL >2M subscription - International
	EUS_LL 2M subscription - International
	EUS_LL 2M subscription - National
	EUS_LL_Analog National Subscription - National
	EUS_X25
Telephony access	NLS4_0_ISDN-PRA_access
	NLS4_0_PSTN_access
TV services	NLS4_0_BroadcastTV
	NLS4_0_iDTV
Voice services in backbone	NLS4_0_FixedSwitchedVoice_transport_National_offnet
	NLS4_0_RemotelyAggregatedVoice_transport
Wholesale transport capacity	EUS_Bandwidth_Wholesale subscription
	EUS_Nat IC-Infra Wholesale subscription

7.5.3 Contributors to the transmission infrastructure

7.5.3.1 Local Tail

A local tail transmission service is made of equipment installed at the customer premises extracting the digital signal from the physical line, of a physical link between the customer site and the central office and of grooming equipment in the central office (or subtended optical nodes).

Depending on the bandwidth of the local tail different equipment technologies are installed: PDH on copper, PDH on fibre or SDH on fibre. For the high bandwidth cases (>2Mb/s) a fibre based technology is required whereas for lower bandwidths the choice between fibre and copper technologies exists. However, since fibre local links are much more expensive than copper links, the preferred option for low bandwidth local tails is the copper based solution.

	Contributor to NLS2_0	Driver name
Equipment	NE_PDH SDH equipment	Yearly Incremental Cost
Physical inks	NLS1_0_Raw_Copper	Nbr_of_used_pairs
	NLS1_0_Continue_Raw_Copper	Nbr_of_used_pairs
	NLS1_0_Fibre_connect_to_the_office	Nb_access_fibres_used

7.5.3.2 Transport Segments

Transport segments are realised by configuring the SDH clusters in different network stages. The transmission aggregation levels introduced hereabove (section 7.5.1 and Figure 7) are realised by different SDH clusters (regional, core and express SDH rings) interconnected by digital-crossconnects. The SDH rings are made of add-drop multiplexers deployed in LTC for the regional ones, in ZTC for the core ones and in the XTC for the express ones. The equipments within a ring are linked by fibre or by an optical wavelength.

To summarize, the building blocks for the transport segments are:

Contributor to NLS2_0	Driver name
NLS1_0_Fibre_connect_Backbone_SDH_Regional&Core	generic (CAPEX costs from PDH SDH MWE Technology)
NE_PDH SDH equipment	Yearly Incremental Cost
NE_Express_SDH_equipment	Bandwidth (Mbps)

7.6 Network services of the packet based infrastructure (NLS2_1)

7.6.1 Definition

This layer deals with the data collection services (broadband or dedicated) between the customer and the central office (access) and the transport of data central office (backbone). Two technologies coexist as well in the access part as in the backbone part : ATM technology and Ethernet/MPLS technology. Next picture summarizes the end point locations of packet based services. Remark : ATM is outphased and is no longer valuated.

This layer also integrates point to point dedicated Ethernet transparent connections delivered over the DWDM national backbone.

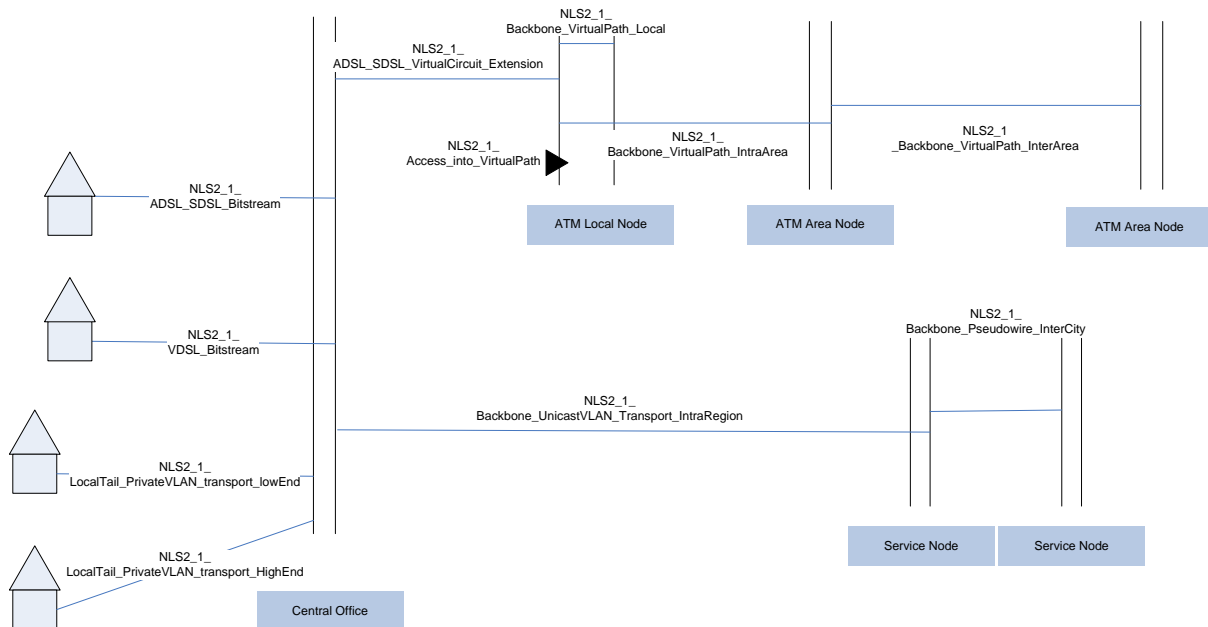

Figure 8: Network services of the packet based infrastructure 2.1

Access part

Layer 2.1 access service	Comment
NLS2_1_ADSL_SDSL_Bitstream	Broadband (ADSL-SDSL) end to end data streams between customer site and aggregation point in central office
NLS2_1_VDSL_Bitstream	Broadband VDSL end to end data streams between customer site and aggregation point in central office
NLS2_1_LocalTail_PrivateVLAN_transport_lowEnd	Ethernet symmetric dedicated link with central office over copper
NLS2_1_LocalTail_PrivateVLAN_transport_HighEnd	Ethernet symmetric dedicated link with central office over fibre
NLS2_1_LocalTailCapacity_Ethernet>=10M	High bandwidth transparent Ethernet frame transport between customer and central office (BLES local tail)

NLS2_1_LocalTail_Eline_HighEnd	Ethernet symmetric dedicated link with central office
--------------------------------	---

Backbone part

For data transport between central offices, the end point locations of the layer 2.1 services depend on the technology, the underlying networks having different topologies.

For the Ethernet/MPLS technology , the following services are defined:

Layer 2.1 Ethernet transport service	Comment
NLS2_1_Backbone_UnicastVLAN_Transport_IntraRegion	MPLS Transport of Ethernet VLANs between a central office and the service node of the region. These VLANs are unicast
NLS2_1_Backbone_Pseudowire_InterCity	MPLS Transport of Ethernet VLANs between service nodes of different regions. These VLANs are unicast
NLS2_1_Backbone_MulticastVPLS_IntraRegion	

Eventually , the dedicated Ethernet transparent connections also introduce backbone connectivity services :

Layer 2.1 Ethernet transparent transport	Comment
NLS2_1_Intra/InterZonalBackboneCapacity_Ethernet>=1G	Any combination of end points different that of the two of them being express transmission centers, bandwidth of 1/10Gbps.
NLS2_1_InterCityBackboneCapacity_Ethernet>=1G	End points are between two express transmission centers, bandwidth of 1/10Gbps.

7.6.2 Usage of the data packet infrastructure

The access services of the data packet infrastructure are combined with the data packet backbone services to deliver end-to-end connectivity between IP appliances at customer site (IP router in ADSL/VDSL modems, private LAN IP routers) and IP service nodes , primarily the broadband access servers and the IPVPN routers offering layer3 services like ADSL/SDSL IP collection, VoD IP collection, Private VLAN extensions up to IPVPN nodes.

Next table summarizes the drivers used expressing how NLS2.1 contribute in layer 3 services or directly to End user services.

NLS2.1 service	Driver Name	Upper layer services "consuming" NLS2.1 services
NLS2_1_xDSL_Bitstream	Nbr_of_used_xDSL_BROBA_lines	BROBA end user line, all broadband IP collections (public internet, VoD, VoIP), and broadband access to IP VPN
NLS2_1_Access_into_VirtualPath	Configured_Bandwidth(Gbps)	Symmetric accesses to IPVPN and BROBA access line

NLS2_1_Backbone_MulticastVPLS_IntraRegion	direct	For television
NLS2_1_Backbone_Pseudowire_InterCity	PeakBandwidth (Mbps) The PeakBandwidth is a realistic estimation (based on measurements in the network) of the traffic (Mbps) during peak hour.	Broadband public IP NLS3 service, VoIP , Broadcast TV, and private IPVPN routing.
NLS2_1_Backbone_UnicastVLAN_Transport_IntraRegion	PeakBandwidth (Mbps)	Broadband public IP NLS3 service, VoIP , VoD and access to private IPVPN routing, Ethernet backhaul and WBA transport.
NLS2_1_Backbone_VirtualPath_InterArea	VP bandwidth Gbps	BROBA transport, Broadband public IP NLS3 service, VoIP , VoD and access to private IPVPN routing
NLS2_1_Backbone_VirtualPath_IntraArea	VP equivalent bandwidth Gbps (Topological efficiency and QoS aspects are translated in bandwidth +or- committed bandwidth)	
NLS2_1_Backbone_VirtualPath_Local	VP equivalent bandwidth Gbps (Topological efficiency and QoS aspects are translated in bandwidth +or- committed bandwidth)	
NLS2_1_InterCityBackboneCapacity_Ethernet>=1G	Bandwidth (Mbps)	BLES EUS services, High capacity accesses to IPVPN, IP-VPN routers interconnection, internal networks routers interconnction
NLS2_1_IntraZonalBackboneCapacity_Ethernet>=1G	Bandwidth (Mbps)	
NLS2_1_InterZonalBackboneCapacity_Ethernet>=1G	Bandwidth (Mbps)	
NLS2_1_LocalTailCapacity_Ethernet>=10M	Bandwidth (Mbps)	
NLS2_1_LocalTail_PrivateVLAN_transport_HighEnd	direct	Access to IPVPN layer 3 services
NLS2_1_LocalTail_PrivateVLAN_transport_lowEnd	direct	Access to IPVPN layer 3 services

7.6.3 Contributors to the data packet infrastructure services

NLS2_1 ADSL SDSL Bitstream is the result of the central office (the Proximus technical building closest to the end customer) based network element NE_ADSL equipment. That function interacts with the broadband CPE equipment (at the customer site) by means of copper connectivity and potentially fiber connectivity to optical subtended nodes.

The Ethernet based layer 2.1 services (NLS2_1_Backbone_Uni/MulticastVPLS_IntraRegion and NLS2_1_Backbone_Pseudowire_InterCity) are implemented by the configuration of the Ethernet/MPLS network elements interacting with each other using lower layer connectivity services (see picture Figure 9).

NLS2_1 VDSL Bitstream is the result of the function present in the deployed VDSL equipment (network elements NE_NGA Active equipment and NE_NGA Housing).

That function interacts with the broadband CPE equipment (at the customer site) by means of copper and fibre connectivity.

NLS2_1 Backbone UnicastVLAN Transport IntraRegion is the result of the Ethernet/MPLS unicast function present in the deployed Ethernet equipment. The function is activated in different locations to form aggregation clusters, whose links are mainly deployed on DWDM and in a limited number by direct fibre connectivity. The NLS2_1 Backbone Pseudowire InterCity and the NLS2_1 Backbone MulticastVPLS IntraRegion are implemented in the exact same way.

NLS2_1 LocalTail PrivateVLAN transport HighEnd or LowEnd and NLS2_1 LocalTail Eline HighEnd are the result of customer sited Ethernet equipment and the connectivity to the Proximus network. Such connectivity consists of a fibre based link for the high end cases and of a copper based link in the low end situation.

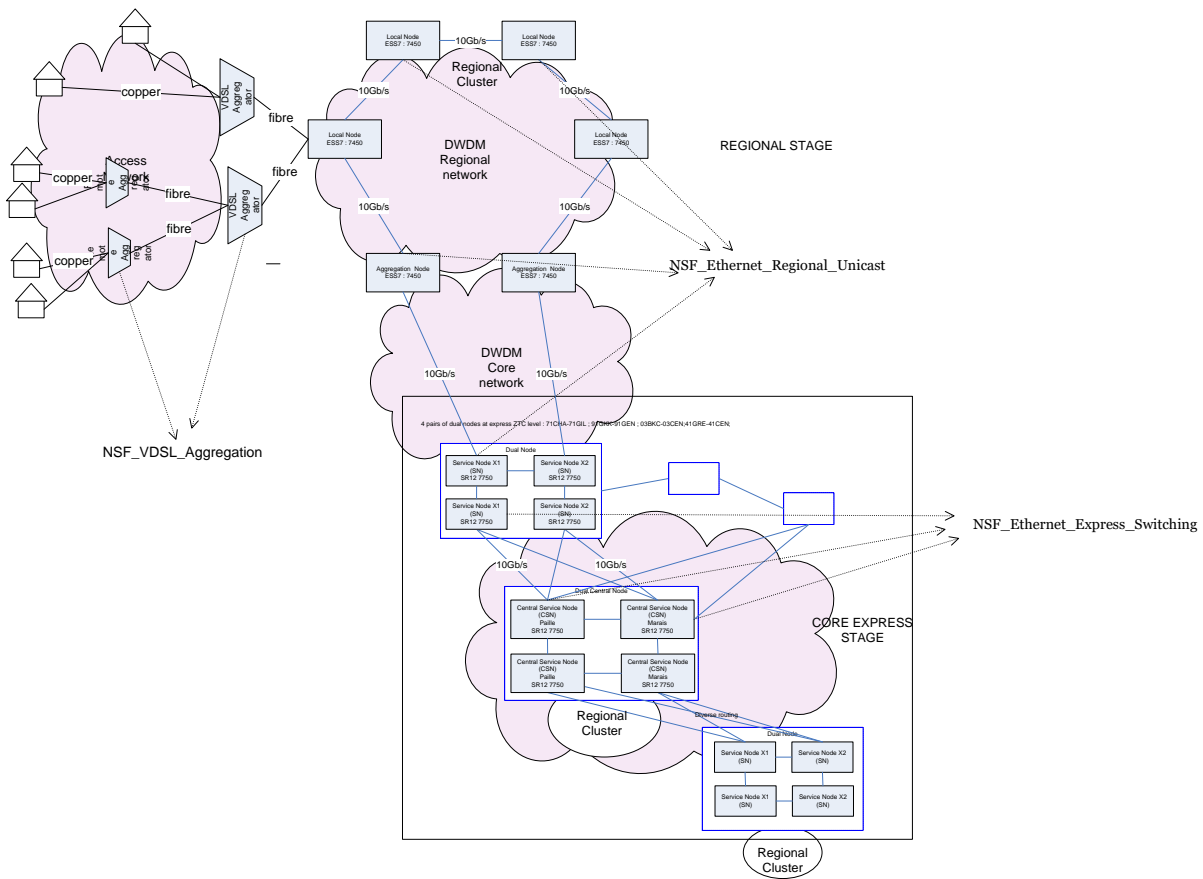

Figure 9: Ethernet layer 2.1

The dedicated Ethernet transparent backbone connection services (NLS2_1_xxxBackboneCapacity_Ethernet>=1G) are realized over the DWDM network with its Add Drop Multiplexers (ADM) or, when the capacity of the ADMs and rings is not sufficient, over point to point DWDM links.

The dedicated Ethernet transparent local tail connection services NLS2_1_LocalTailCapacity_Ethernet>=10M, is realized either on SDH equipment (up to 100 Mbps), reusing the SDH clusters deployed and already discussed in 7.5.3 (SDH over fibre) or for very high capacity connections (above 100 Mbps) they are directly realized on a wavelength (deployed as Fibre_connect_to_the_office for the local tail and as (D)WDM for the other cases).

The table hereunder summarizes the drivers used to distribute the cost contributors to the NLS2.1 services.

NLS2_1 service category	Building block of layer 2_1 service	Driver name
Ethernet transport	NE_DWDM_ADM_Cluster	Number of Lambda
	NE_DWDM_ADM_Core	Number of Lambda
	NE_DWDM_Transponder	Number of Transponder
	NSF_Express_DWDM_ADM	Number of Lambda
	NSF_Express_DWDM_Transponder	Number of Transponder

	NE_EthernetSwitch_Chassis	Usage of Switch in Percentage
	NE_EthernetSwitch_Port10GE	Number of Port
	NE_EthernetSwitch_Port1GE	Number of Port
	NE_EthernetSwitch_Port1GE_Adapter	Number of Adapter
	NSF_Express_EthernetSwitch_Chassis	Traffic in Mbps
	NLS1_0_Fibre_connect_Backbone_DWDM_Express	generic (CAPEX costs from Express DWDM equipment)
Broadband aggregation	NLS1_0_Fibre_connect_Backbone_DWDM_Regional&Core	generic (CAPEX costs from DWDM equipment)
	NE_ADSL equipment	direct
	NE_NGA Active equipment	direct
	NE_NGA Housing	direct
	NLS1_0_Copper_Localloop_testing	nbr of broadband lex based without voice
	NLS1_0_Copper_Subloop	direct
	NLS1_0_Copper_Subloop_testing	Nbr_of_used_pairs
	NLS1_0_Fibre_connect_to_the_OpticalNode	Nb_access_fibres_used
	NLS1_0_Raw_Copper	Nbr_of_used_pairs
	NLS2_0_InterCityBackboneCapacity>2M	Bandwidth (Mbps)
	NLS2_0_IntraAreaBackboneCapacity>2M	Bandwidth (Mbps)
	NLS2_0_IntraZonalBackboneCapacity>2M	Bandwidth (Mbps)
	NLS2_0_LocalBackboneCapacity>2M	Bandwidth (Mbps)
	NSF_FTTC_FibreConnectivity	direct
Ethernet local tail	NE_ethernet equipment	Yearly Direct CAPEX Cost
	NLS1_0_Continue_Raw_Copper	Nbr_of_used_pairs
	NLS1_0_Fibre_connect_to_the_office	Nb_access_fibres_used
	NLS1_0_Raw_Copper	Nbr_of_used_pairs
Transparent Ethernet backbone connection services	NE_DWDM_ADM_Cluster	Number of Lambda
	NE_DWDM_ADM_Core	Number of Lambda
	NE_DWDM_Point_to_Point_InterZonal	Direct
	NE_DWDM_Point_to_Point_IntraZonal	Direct
	NE_DWDM_Transponder	Number of Transponder
	NSF_Express_DWDM_ADM	Number of Lambda
	NSF_Express_DWDM_Amplifier	Number of Lambda
	NSF_Express_DWDM_Point_to_Point	Direct
	NSF_Express_DWDM_Transponder	Number of Transponder
	NLS1_0_Fibre_connect_Backbone_DWDM_Express	generic (CAPEX costs from Express_DWDM_equipment)
NLS1_0_Fibre_connect_Backbone_DWDM_Regional&Core	generic (CAPEX costs from DWDM equipment)	
NLS1_0_Fibre_connect_to_the_office	Nb_access_fibres_used	

The cost relative to the building blocks and the driver values, for Ethernet transport and Transparent Ethernet backbone connection services, are determined in a top-down model, which was derived from the BIPT NGN-NGA model. (by Analysis Mason)

7.7 Network services of the mobile backhauling infrastructure (NLS 2.2)

7.7.1 Leased Lines infrastructure for mobile access backhauling

- NLS2_2_Mobile_Access_Backhaul_Abis is related to backhauling of the 2G network, providing connectivity by means of leased lines between the Base Station Transceiver (BTS) and the Base Station controller (BSC).

- NLS2_2_Mobile_Access_Backhaul_luB is related to backhauling of the 3G network, providing connectivity by means of leased lines between the Node B antenna and the Radio Network Controller (RNC) in the Radio Access Network.

7.8 Network services of the IP infrastructure layer (NLS3-IP)

7.8.1 Scope

This layer provides the following basic IP services in the model.

Fixed IP service type	IP service
Collection of IP traffic for public internet or internal internet	NLS3_xDSL_Public_IP_collection
	NLS3_VoD_IP_collection
	NLS3_VoIP_IP_collection
	NLS3_Public_IP_Extension_on_symmetric
Public Internet routing	NLS3_Public_IP_switching
Connection of IP sites to IP-VPN	NLS3_Private_IP&Ethernet_Extension_on_symmetric_HighEnd
	NLS3_Private_IP&Ethernet_Extension_on_symmetric_LowEnd
	NLS3_Private_IP&Ethernet_Routing
	NLS3_Private_IP&Ethernet_Extension_on_asymmetric
	NLS3_Private_IP&Ethernet_Extension_on_symmetric_Datacenter
IP security	NLS3_IP_security

In addition, NLS3 also includes collection of mobile data traffic in the mobile access and backbone network.

The actual NLS3's are described further. A comprehensive listing of which NLS or EUS they contribute to together with a description of the driver utilized in each case is also presented.

7.8.1.1 Public services

7.8.1.1.1 IP_collection

Gathers all the data traffic, except that of the private networks, generated by the customers at their locations -homes and offices placed all over the country- at the highest network level where it can be further delivered to the Internet.

This gathering is achieved thanks to the broad and narrow band servers together with the connectivity capabilities of the MPLS backbone network.

This generic service is in fact divided in several actual NLS3, depending on the traffic type and/or underlying technology, as follows:

- Data traffic:
 - NLS3_xDSL_Public_IP_Collection

- NLS3_Public_IP_Extension_on_symmetric: where the customer-IP router connectivity is provided by means of Leased Lines, as opposed to the other services which are based on broadband access technologies.
- Video on Demand traffic:
 - NLS3_VoD_IP_Collection
- Voice over IP traffic:
 - NLS3_VoIP_IP_Collection

Further, these NLS3's contribute to the following higher network layer services and end user services (EUS) as specified hereunder:

NLS3	Driver name	Target element
NLS3_xDSL_Public_IP_collection	Nbr_of_retail_wholesale_xDSL_lines	EUS_xDSL_Carrier_wholesale subscription
	Nbr_of_retail_wholesale_xDSL_lines	EUS_FastInternet subscription
NLS3_Public_IP_Extension_on_symmetric	Direct	EUS_Public_IP_Extension_on_Symmetric
NLS3_VoD_IP_collection	Direct	NLS4_0_VoD
NLS3_VoIP_IP_collection	Direct	NLS4_0_PSTN_access

7.8.1.1.2 Public IP switching

This service brings the intelligence to route the gathered traffic by the “IP_collection” generic NLS3 into the appropriate external network within the “public Internet”.

This service, NLS3_Public_IP_switching, is fully and exclusively realized by the Proximus Internet Routers and is totally dedicated to the end user service EUS_FastInternet subscription.

7.8.1.2 Private services

7.8.1.2.1 Private IP&Ethernet Extension

This NLS transparently extends the customer's private local area networks, situated at any location within Belgium, to the edge of the Proximus's network, thanks to the routers installed at the customer premises (CPE) and the connectivity capabilities of the MPLS aggregation and core- clouds.

This generic service consists in fact of several actual services, specific to the access technology type, as follows:

- NLS3_Private_IP&Ethernet_Extension_on_symmetric_Datacenter
- NLS3_Private_IP&Ethernet_Extension_on_asymmetric
- NLS3_Private_IP&Ethernet_Extension_on_symmetric_lowEnd
- NLS3_Private_IP&Ethernet_Extension_on_symmetric_highEnd

The higher level NLS/EUS to which the above NLS3's deliver their services and their costs allocations are:

NLS3	Driver name	Target element
NLS3_Private_IP&Ethernet_Extension_on_asymmetric	Number of Access	EUS_Private_IP&Ethernet_on_backup
NLS3_Private_IP&Ethernet_Extension_on_asymmetric	Number of Access	EUS_Private_IP&Ethernet_on_asymme tric subscription – National

NLS3_Private_IP&Ethernet_Extension_on_symmetric_Datcenter	direct	EUS_DataManagedServices
NLS3_Private_IP&Ethernet_Extension_on_symmetric_HighEnd	Number of Access	EUS_Private_IP&Ethernet_on_backup
NLS3_Private_IP&Ethernet_Extension_on_symmetric_HighEnd	Number of Access	EUS_Private_IP&Ethernet_on_symmetric_HighEnd Subscription – National
NLS3_Private_IP&Ethernet_Extension_on_symmetric_LowEnd	Number of Access	EUS_Private_IP&Ethernet_on_backup
NLS3_Private_IP&Ethernet_Extension_on_symmetric_LowEnd	Number of Access	EUS_Private_IP&Ethernet_on_symmetric_lowEnd Subscription – National

7.8.1.2.2 NLS3_Private_IP&Ethernet_Routing

This NLS delivers the capability of routing the private networks traffic to the requested end point, within the Proximus private IPVPN network.

This service, NLS3_Private_IP&Ethernet_Routing, is completed by the Proximus IPVPN Routers and the core MPLS cloud and, in turn, supports all the following EUS:

NLS3	Driver name	Target element
NLS3_Private_IP&Ethernet_Routing	PeakBandwidth (Mbps)	EUS_Private_IP&Ethernet_on_asymmetric_subscription - National
NLS3_Private_IP&Ethernet_Routing	PeakBandwidth (Mbps)	EUS_Private_IP&Ethernet_on_symmetric_HighEnd Subscription - National
NLS3_Private_IP&Ethernet_Routing	PeakBandwidth (Mbps)	EUS_Private_IP&Ethernet_on_international Subscription
NLS3_Private_IP&Ethernet_Routing	PeakBandwidth (Mbps)	EUS_DataManagedServices
NLS3_Private_IP&Ethernet_Routing	PeakBandwidth (Mbps)	EUS_Private_IP&Ethernet_on_symmetric_lowEnd Subscription - National

Figure 10: Layer 3 topology and contributors exhibits the layer's basic topology and all the contributors to the Layer 3 services.

NLS3 - IP

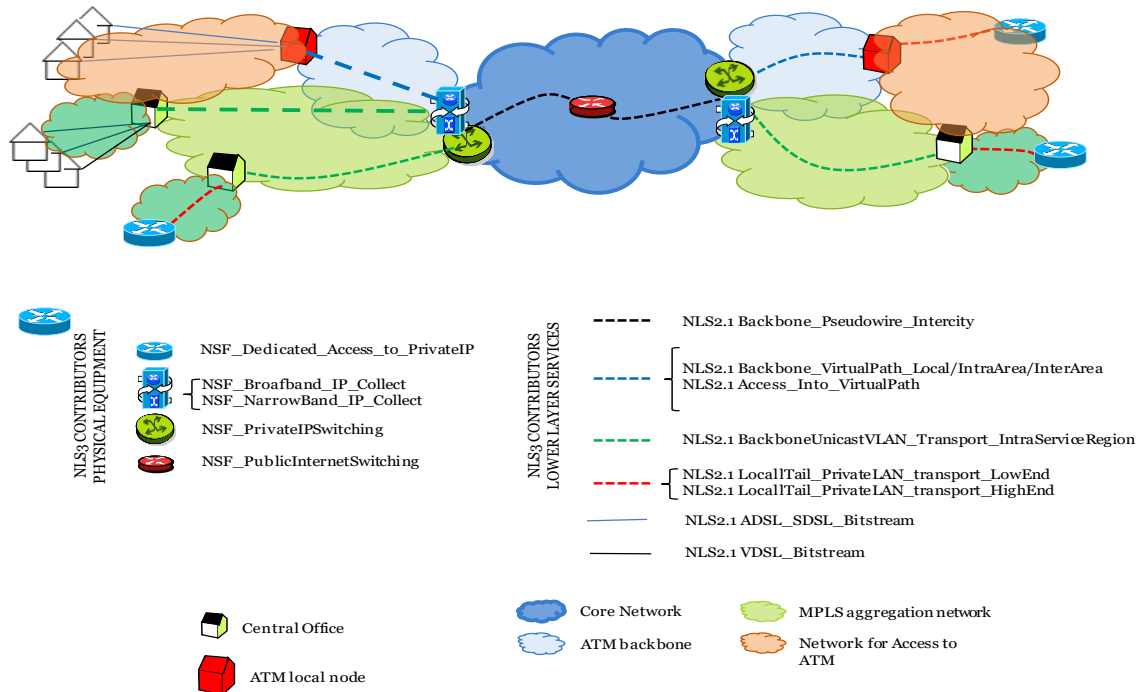

Figure 10: Layer 3 topology and contributors

7.8.1.3 Mobile Data traffic

The network layer 3 elements included at this level are :

- NLS3_o_BGC_Mobile_Access_Data
- NLS3_o_BGC_Mobile_Backbone_Data

7.8.2 Contributors to the Network Layer 3 services

The table hereunder summarizes the contributors and the drivers used to distribute the costs to the NLS3 services.

NLS3 service category	Building block of layer 3 service	Driver name
Asymmetric Private_IP&Ethernet_Extension	NLS2_1_xDSL_Bitstream	Nbr_of_used_xDSL_BROBA_lines
	NLS2_1_Backbone_UnicastVLAN_Transport_IntraRegion	PeakBandwidth (Mbps)
	NLS2_1_Backbone_VirtualPath_InterArea	VP bandwidth Gbps
	NLS2_1_Backbone_VirtualPath_IntraArea	VP equivalent bandwidth Gbps (Topological efficiency and QoS aspects)

		are translated in bandwidth +or-committed bandwidth)
	NLS2_1_Backbone_VirtualPath_Local	VP equivalent bandwidth Gbps (Topological efficiency and QoS aspects are translated in bandwidth +or-committed bandwidth)
	NSF_Dedicated_Access_to_PrivateIP	Number of Access
Symmetric Private_IP&Ethernet_Extension	NLS2_0_InterCityBackboneCapacity<2M	Bandwidth (Mbps)
	NLS2_0_InterCityBackboneCapacity=2M	Bandwidth (Mbps)
	NLS2_0_InterCityBackboneCapacity>2M	Bandwidth (Mbps)
	NLS2_0_IntraAreaBackboneCapacity<2M	Bandwidth (Mbps)
	NLS2_0_IntraAreaBackboneCapacity=2M	Bandwidth (Mbps)
	NLS2_0_IntraAreaBackboneCapacity>2M	Bandwidth (Mbps)
	NLS2_0_IntrazonalBackboneCapacity<2M	Bandwidth (Mbps)
	NLS2_0_IntrazonalBackboneCapacity=2M	Bandwidth (Mbps)
	NLS2_0_IntrazonalBackboneCapacity>2M	Bandwidth (Mbps)
	NLS2_0_LocalBackboneCapacity<2M	Bandwidth (Mbps)
	NLS2_0_LocalBackboneCapacity=2M	Bandwidth (Mbps)
	NLS2_0_LocalBackboneCapacity>2M	Bandwidth (Mbps)
	NLS2_0_LocalTail<2M	Nbr_of_Customer_sites
	NLS2_0_LocalTail=2M	Nbr_of_Customer_sites
	NLS2_0_LocalTail>2M	Nbr_of_Customer_sites
	NLS2_1_Access_into_VirtualPath	Configured_Bandwidth(Gbps)
	NLS2_1_xDSL_Bitstream	Nbr_of_used_xDSL_BROBA_lines
	NLS2_1_Backbone_UnicastVLAN_Transport_IntraRegion	PeakBandwidth (Mbps)
	NLS2_1_Backbone_VirtualPath_InterArea	VP bandwidth Gbps
	NLS2_1_Backbone_VirtualPath_IntraArea	VP equivalent bandwidth Gbps (Topological efficiency and QoS aspects are translated in bandwidth +or-committed bandwidth)
	NLS2_1_Backbone_VirtualPath_Local	VP equivalent bandwidth Gbps (Topological efficiency and QoS aspects are translated in bandwidth +or-committed bandwidth)
	NLS2_1_BackboneCapacity_Ethernet>=10M	Bandwidth (Mbps)
	NLS2_1_InterCityBackboneCapacity_Ethernet>=10M	Bandwidth (Mbps)
	NLS2_1_LocalTail_PrivateVLAN_transport_lowEnd	Direct

	NLS2_1_LocalTailCapacity_Ethernet>=10M	Bandwidth (Mbps)
	NSF_Dedicated_Access_to_PrivateIP	Nbr_of_Sites
Symmetric Public_IP_Extension	NLS2_0_InterCityBackboneCapacity=2M	Bandwidth (Mbps)
	NLS2_0_IntrazonalBackboneCapacity=2M	Bandwidth (Mbps)
	NLS2_0_LocalBackboneCapacity=2M	Bandwidth (Mbps)
	NLS2_0_LocalTail=2M	Nbr_of_Customer_sites
	NLS2_1_BackboneCapacity_Ethernet>=10M	Bandwidth (Mbps)
	NLS2_1_LocalTailCapacity_Ethernet>=10M	Bandwidth (Mbps)
Public_IP_collection	NLS2_0_InterCityBackboneCapacity>2M	Bandwidth (Mbps)
	NLS2_0_IntraAreaBackboneCapacity>2M	Bandwidth (Mbps)
	NLS2_0_IntrazonalBackboneCapacity>2M	Bandwidth (Mbps)
	NLS2_0_LocalBackboneCapacity>2M	Bandwidth (Mbps)
	NLS2_1_ADSL_SDSL_Bitstream	Nbr_of_used_xDSL_BROBA_lines
	NLS2_1_Backbone_UnicastVLAN_Transport_IntraRegion	PeakBandwidth (Mbps)
	NLS2_1_Backbone_VirtualPath_InterArea	VP bandwidth Gbps
	NLS2_1_Backbone_VirtualPath_IntraArea	VP equivalent bandwidth Gbps (Topological efficiency and QoS aspects are translated in bandwidth +or-committed bandwidth)
	NLS2_1_Backbone_VirtualPath_Local	VP equivalent bandwidth Gbps (Topological efficiency and QoS aspects are translated in bandwidth +or-committed bandwidth)
	NSF_BroadBand_Public_IP_Collect	PeakHour_PublicInternetTraffic(Gbps)
VoD_IP_collection	NLS2_1_xDSL_Bitstream	Nbr_of_used_xDSL_BROBA_lines
	NLS2_1_Backbone_UnicastVLAN_Transport_IntraRegion	PeakBandwidth (Mbps)
	NSF_BroadBand_VoD_IP_Collect	PeakHour_VoDTraffic(Gbps)
VoIP_IP_collection	NLS2_1_Backbone_Pseudowire_InterCity	PeakBandwidth (Mbps)
	NLS2_1_Backbone_UnicastVLAN_Transport_IntraRegion	PeakBandwidth (Mbps)
	NSF_BroadBand_VoIP_IP_Collect	Direct
Public_IP_switching	NLS2_0_InterCityBackboneCapacity=2M	Bandwidth (Mbps)
	NLS2_0_InterCityBackboneCapacity>2M	Bandwidth (Mbps)
	NLS2_0_IntrazonalBackboneCapacity=2M	Bandwidth (Mbps)
	NLS2_0_IntrazonalBackboneCapacity>2M	Bandwidth (Mbps)

	NLS2_0_LocalBackboneCapacity=2M	Bandwidth (Mbps)
	NLS2_0_LocalBackboneCapacity>2M	Bandwidth (Mbps)
	NLS2_1_BackboneCapacity_Ethernet>=10M	Bandwidth (Mbps)
	NLS2_1_InterCityBackboneCapacity_Ethernet>=10M	Bandwidth (Mbps)
	NLS2_1_LocalTailCapacity_Ethernet>=10M	Bandwidth (Mbps)
	NSF_PublicInternetSwitching	TotalPeakHour_PublicInternetTraffic(Gbps)
Private_IP&Ethernet_Routing	NLS2_0_IntrazonalBackboneCapacity=2M	Bandwidth (Mbps)
	NLS2_0_LocalBackboneCapacity=2M	Bandwidth (Mbps)
	NLS2_0_LocalBackboneCapacity>2M	Bandwidth (Mbps)
	NLS2_1_Backbone_Pseudowire_InterCity	Bandwidth (Mbps)
	NLS2_1_Backbone_VirtualPath_InterArea	VP bandwidth Gbps
	NLS2_1_Backbone_VirtualPath_IntraArea	VP equivalent bandwidth Gbps (Topological efficiency and QoS aspects are translated in bandwidth +or-committed bandwidth)
	NLS2_1_Backbone_VirtualPath_Local	VP equivalent bandwidth Gbps (Topological efficiency and QoS aspects are translated in bandwidth +or-committed bandwidth)
	NLS2_1_BackboneCapacity_Ethernet>=10M	Bandwidth (Mbps)
	NLS2_1_InterCityBackboneCapacity_Ethernet>=10M	Bandwidth (Mbps)
NSF_PrivateIPSwitching	Direct	
IP_security	NSF_IP_security	Direct
Mobile Data Handling	NSF_Mobile_RAN_Data	Routed volumes
	NSF_Mobile_Backbone_Data	Routed volumes

7.9 Network Services of the application layer

7.9.1 Definition

This layer deals with the telecommunication application services to end users. The application layer services are:

NLS4_o_BroadcastTV, NLS4_o_VoD, NLS4_o_iDTV and voice telephony related services classified as follows:

Class of Application Service	Application Service
------------------------------	---------------------

Access to VoiceCallHandling	NLS4_0_Voice_traffic_PointOfInterconnect
Mobile IN Platform	NLS4_0_Mobile_Data_Services
	NLS4_0_Mobile_Traffic_Services
	NLS4_0_Private_Communication_Call_Handling
	NLS4_0_SMS_Services
Mobile Voice&Messaging Handling	NLS4_0_BGC Mobile_Access_Collect_SMS
	NLS4_0_BGC Mobile_Access_Collect_Voice
	NLS4_0_BGC Mobile_Access_Distribute_SMS
	NLS4_0_BGC Mobile_Access_Distribute_Voice
	NLS4_0_BGC Mobile_BackBone_SMS
	NLS4_0_BGC Mobile_BackBone_Voice
	NLS4_0_MobileTerminatingLinks
Special	NLS4_0_Automated_call_distribution
Telephony Access	NLS4_0_ISDN_access
	NLS4_0_ISDN-PRA_access
	NLS4_0_PSTN_access
TV	NLS4_0_BroadcastTV
	NLS4_0_iDTV
	NLS4_0_VoD
VAS application	NLS4_0_Advanced_Number_Translation_CallHandling
	NLS4_0_Advanced_CallHandling
	NLS4_0_Voicemail&Messaging
Voice transport	NLS4_0_BGC MobileSwitchedVoice_transport_National_offnet
	NLS4_0_FixedSwitchedVoice_transport_National_offnet
	NLS4_0_RemotelyAggregatedVoice_transport
VoiceCallHandling	NLS4_0_Voice_traffic_Collect
	NLS4_0_Voice_traffic_OnNet
	NLS4_0_Voice_traffic_Terminate
	NLS4_0_Voice_traffic_Transit

For the access, the voice application services are end-to-end voice connections between the customer site and the central office (technical building closest to the user). For the backbone, voice applications are either pure call handling related and do not span over distant nodes, or they are voice transport applications between distant nodes.

7.9.2 Usage of the application layer

The TV related applications are completely used for iDTV end-user services, no specific consumption driver needs to be defined.

The voice application services are distributed to a variety of traffic types , each with a specific driver. The following table summarizes the used drivers per voice application service.

Class of Application Service	Application Service	Driver to distribute the NLS4.0 application service to EUS or NLS4.1
Access to VoiceCallHandling	NLS4_0_Voice_traffic_PointOfInterconnect	TimeSlot_capacity_used
Mobile IN Platform	NLS4_0_Mobile_PrepaidData_Services	cumulated invested value
	NLS4_0_Mobile_PrepaidTraffic_Services	cumulated invested value
	NLS4_0_Private_Communication_Call_Handling	cumulated invested value
	NLS4_0_SMS_Services	cumulated invested value
Mobile Voice&Messaging Handling	NLS4_0_BGC Mobile_Access_Collect_SMS	routed volumes
	NLS4_0_BGC Mobile_Access_Collect_Voice	routed minutes
	NLS4_0_BGC Mobile_Access_Distribute_SMS	routed volumes
	NLS4_0_BGC Mobile_Access_Distribute_Voice	routed minutes
	NLS4_0_BGC Mobile_BackBone_SMS	routed volumes
	NLS4_0_BGC Mobile_BackBone_Voice	routed minutes
	NLS4_0_MobileTerminatingLinks	routed minutes
Special	NLS4_0_Automated_call_distribution	direct
Telephony Access	NLS4_0_ISDN_access	Nbr_equilines_inUse
	NLS4_0_ISDN-PRA_access	Nbr_equilines_inUse
	NLS4_0_PSTN_access	Nbr_equilines_inUse
TV	NLS4_0_BroadcastTV	direct
	NLS4_0_iDTV	direct
	NLS4_0_VoD	direct
VAS application	NLS4_0_Advanced_Number_Translation_CallHandling	NumberTranslationProcessedTime(min)
	NLS4_0_Advanced_CallHandling	direct
	NLS4_0_Voicemail&Messaging	direct
Voice transport	NLS4_0_BGC	
	MobileSwitchedVoice_transport_National_offnet	routed minutes
	NLS4_0_FixedSwitchedVoice_transport_National_offnet	TimeSlot_capacity_used
VoiceCallHandling	NLS4_0_RemotelyAggregatedVoice_transport	routed minutes
	NLS4_0_Voice_traffic_Collect	routed minutes
	NLS4_0_Voice_traffic_OnNet	routed minutes
	NLS4_0_Voice_traffic_Terminate	routed minutes
	NLS4_0_Voice_traffic_Transit	routed minutes

The driver “routed minutes” (or “routed volumes” in the case of mobile SMS) consists in determining the average number of times (=routing factor) a traffic type is using the voice application service across all possible call scenarios compatible with the traffic type. The routed minutes result from multiplication of the routing factor with the amount of calls (expressed in minutes) of that traffic type.

The traffic types (“consumers”) of these voice applications are:

Class of Application Service	End User Service
Access to VoiceCallHandling	EUS_voice_traffic_Fixed_on_net_to Mobile_national EUS_voice_traffic_Fixed_outbound_intal EUS_voice_traffic_Fixed_outbound_intal_VAS EUS_voice_traffic_Fixed_outbound_national_to FOLO EUS_voice_traffic_Fixed_outbound_national_to MOLO EUS_voice_traffic_Fixed_outbound_VAS_national EUS_voice_traffic_Fixed_transit_intal EUS_voice_traffic_Fixed_transit_national EUS_Voice_traffic_IAA_PointOfInterconnect subscription EUS_voice_traffic_Mobile_on_net_to Fixed EUS_voice_traffic_Mobile_on_net_VAS_national EUS_voice_traffic_Mobile_outbound_national_to FOLO EUS_voice_traffic_Mobile_outbound_VAS_national EUS_voice_traffic_Mobile_Roaming_IN_Origination EUS_voice_traffic_Mobile_Roaming_IN_Termination
Mobile IN Platform	EUS_BGC Mobile_Roaming Out data EUS_Mobile_Data national EUS_SMS_on_net_national EUS_SMS_outbound_intal EUS_SMS_outbound_national EUS_SMS_Roaming_OUT_Origination EUS_voice_traffic_Fixed_on_net_to Mobile_national EUS_voice_traffic_Mobile_inbound_intal EUS_voice_traffic_Mobile_on_net_to Fixed EUS_voice_traffic_Mobile_on_net_to Mobile EUS_voice_traffic_Mobile_on_net_VAS_national EUS_voice_traffic_Mobile_outbound_intal EUS_voice_traffic_Mobile_outbound_national_to FOLO EUS_voice_traffic_Mobile_outbound_to MOLO EUS_voice_traffic_Mobile_outbound_VAS_national EUS_voice_traffic_Mobile_Roaming_out_Origination
Special	EUS_AUTOMATEDCALLDISTRIBUTION
Telephony Access	EUS_Voice_mutichannels EUS_Voice_one_channel
TV	EUS_IDTV_subscription
Voice transport	EUS_Carrier PreSelection EUS_notAllocated EUS_SMS_outbound_intal EUS_SMS_outbound_national EUS_SMS_Roaming_IN_Origination EUS_voice_traffic_Fixed_inbound_intal EUS_voice_traffic_Fixed_inbound_intal_VAS EUS_voice_traffic_Fixed_inbound_national

VoiceCallHandling

EUS_voice_traffic_Fixed_inbound_VAS_national
EUS_voice_traffic_Fixed_on_net_national
EUS_voice_traffic_Fixed_on_net_to Mobile_national
EUS_voice_traffic_Fixed_on_net_VAS_national
EUS_voice_traffic_Fixed_outbound_intal
EUS_voice_traffic_Fixed_outbound_intal_VAS
EUS_voice_traffic_Fixed_outbound_national_to FOLO
EUS_voice_traffic_Fixed_outbound_national_to MOLO
EUS_voice_traffic_Fixed_outbound_VAS_national
EUS_voice_traffic_Fixed_transit_intal
EUS_voice_traffic_Fixed_transit_national
EUS_voice_traffic_Mobile_inbound_VAS_national
EUS_voice_traffic_Mobile_on_net_to Fixed
EUS_voice_traffic_Mobile_on_net_VAS_national
EUS_voice_traffic_Mobile_outbound_intal
EUS_voice_traffic_Mobile_outbound_intal_VAS
EUS_voice_traffic_Mobile_outbound_national_to FOLO
EUS_voice_traffic_Mobile_outbound_to MOLO
EUS_voice_traffic_Mobile_outbound_VAS_national
EUS_voice_traffic_Mobile_Roaming_IN_Origination
EUS_voice_traffic_Mobile_Roaming_IN_Termination
EUS_voice_traffic_Mobile_Roaming_out_Origination
EUS_voice_traffic_Mobile_Roaming_out_Termination
EUS_Carrier PreSelection
EUS_voice_traffic_Fixed_inbound_intal
EUS_voice_traffic_Fixed_inbound_intal_VAS
EUS_voice_traffic_Fixed_inbound_national
EUS_voice_traffic_Fixed_inbound_VAS_national
EUS_voice_traffic_Fixed_on_net_national
EUS_voice_traffic_Fixed_on_net_to Mobile_national
EUS_voice_traffic_Fixed_on_net_VAS_national
EUS_voice_traffic_Fixed_outbound_intal
EUS_voice_traffic_Fixed_outbound_intal_VAS
EUS_voice_traffic_Fixed_outbound_national_to FOLO
EUS_voice_traffic_Fixed_outbound_national_to MOLO
EUS_voice_traffic_Fixed_outbound_VAS_national
EUS_voice_traffic_Fixed_transit_intal
EUS_voice_traffic_Fixed_transit_national
EUS_voice_traffic_Mobile_inbound_VAS_national
EUS_voice_traffic_Mobile_on_net_to Fixed
EUS_voice_traffic_Mobile_on_net_VAS_national
EUS_voice_traffic_Mobile_outbound_national_to FOLO
EUS_voice_traffic_Mobile_outbound_VAS_national
EUS_voice_traffic_Mobile_Roaming_IN_Origination
EUS_voice_traffic_Mobile_Roaming_IN_Termination
EUS_voice_traffic_Mobile_Roaming_out_Origination

EUS_voice_traffic_OPS

7.9.3 Contributors to the application services

TV services

The broadcast TV application service is the result of the video streaming network stage function and the nationwide broadcast using the SDH clusters and simultaneously the multicast features of the Ethernet/MPLS regional clusters combined with the express pseudowires in order to reach all regional clusters.

Contributor to NLS4_0_BroadcastTV	Driver
NSF_BroadcastTV	Nbr_TV_users
NLS1_0_Fibre_connect_to_the_OpticalNode	Nb_access_fibres_used
NLS2_0_InterCityBackboneCapacity<2M	Bandwidth consumed (Mbit/s)
NLS2_0_InterCityBackboneCapacity=2M	Bandwidth consumed (Mbit/s)
NLS2_0_InterCityBackboneCapacity>2M	Bandwidth consumed (Mbit/s)
NLS2_0_IntraAreaBackboneCapacity<2M	Bandwidth consumed (Mbit/s)
NLS2_0_IntraAreaBackboneCapacity=2M	Bandwidth consumed (Mbit/s)
NLS2_0_IntraAreaBackboneCapacity>2M	Bandwidth consumed (Mbit/s)
NLS2_0_IntraZonalBackboneCapacity>2M	Bandwidth consumed (Mbit/s)
NLS2_0_LocalBackboneCapacity>2M	Bandwidth consumed (Mbit/s)
NLS2_1_Backbone_MulticastVPLS_IntraRegion	Direct
NLS2_1_Backbone_Pseudowire_InterCity	TotalPeakBandwidth_used(Gbps)
NLS2_1_BackboneCapacity_Ethernet>=10M	Bandwidth consumed (Mbit/s)
NLS2_1_InterCityBackboneCapacity_Ethernet>=10M	Bandwidth consumed (Mbit/s)
NLS2_1_LocalTailCapacity_Ethernet>=10M	Bandwidth consumed (Mbit/s)

Similarly, the Video On Demand service is the result of Video Movie servers delivering the content and the transport services towards the closest local node to the customer . The transport is realized on the Ethernet/MPLS network.

Contributor to NLS4_0_VoD	Driver
NLS3_VoD_IP_collection	direct

Voice application services in the access

PSTN access services are the result of the voice concentrator function in the Access Gateways and the physical copper connectivity between the customer site and the Access Gateways (in ROP or in local exchange). In addition, the data connectivity required to transport Voice over IP signaling and traffic to the Voice over IP switching units is also included as a contributor to voice access.

PRA access services do not need a concentrator function (that function is typically realized within the customer site by private switches) but merely a voice transport link to the local exchange. This one is obtained directly from layer 2.0 transport segments and local tails.

Hereunder a summary of the contributors to voice access together with the drivers used to determine their level of involvement in the service

Voice Access Services	Contributor	Driver
NLS4_0_ISDN_access	[NLS1_0_Continue_Raw_Copper]	Nbr_of_used_pairs
	[NLS1_0_Raw_Copper]	Nbr_of_used_pairs
	[NSF_ISDN_NetworkTermination]	Nbr_of_accesses
NLS4_0_ISDN-PRA_access	[NLS1_0_CentralOffice2RemoteOpticalNode_Duct]	Number of physical site routes
	[NLS1_0_CentralOffice2RemoteOpticalNode_Fibre]	Number of physical site routes
	[NLS2_0_InterCityBackboneCapacity<2M]	Bandwidth (Mbps)
	[NLS2_0_InterCityBackboneCapacity=2M]	Bandwidth (Mbps)
	[NLS2_0_IntraAreaBackboneCapacity=2M]	Bandwidth (Mbps)
	[NLS2_0_IntrazonalBackboneCapacity<2M]	Bandwidth (Mbps)
	[NLS2_0_IntrazonalBackboneCapacity=2M]	Bandwidth (Mbps)
	[NLS2_0_LocalBackboneCapacity=2M]	Bandwidth (Mbps)
NLS4_0_PSTN_access	[NLS2_0_LocalTail=2M]	Number_of_customer_sites
	[NLS1_0_Continue_Raw_Copper]	Nbr_of_used_pairs
	[NLS1_0_Raw_Copper]	Nbr_of_used_pairs
	[NLS2_0_IntrazonalBackboneCapacity<2M]	Bandwidth (Mbps)
	[NLS2_0_LocalBackboneCapacity<2M]	Bandwidth (Mbps)
	[NLS3_VoIP_IP_collection]	direct
	[NSF_PairGainSystem]	direct
[NSF_PSTN_Voice_concentrator]	Nbr_equilines_inUse	

Voice application services in the backbone (see picture **Error! Reference source not found.**)

The services in the group “Access to VoiceCallHandling” allow to access the Fixed Voice NGN Platform.

In summary the contributors are distributed using following drivers:

Network functions used to realize Access to Voice Call Handling services	Driver used to attribute network functions to access to VoiceCallHandling services
--	--

[NSF_Interconnecting_CallHandling]	Attributed ecodep of capex from bottom up model
[NSF_OwnNetwork_CallHandling]	Attributed ecodep of capex from bottom up model
[NSF_Voice_call_CAE_Processing]	routed minutes
[NSF_Voice_call_CAE_Trunks]	Nbr Time Slots
[NSF_Voice_o_Broadband_SBC]	Attributed ecodep of capex from bottom up model
[NSF_VoiceIP_Router]	Attributed ecodep of capex from bottom up model

The driver “routed minutes” consists in determining the average nbr of times (=routing factor) a voice call handling type is using the network functions. The routed minutes result from multiplication of the routing factor with the amount of calls (expressed in minutes) exercising that voice call handling type.

The services in the group “Voice transport” are emanating from layer 2.0 Backbone transport capacity (<=2M) which are distributed according to the consumed bandwidth.

Contributor to NLS4_x	Driver	NLS4_x element
NLS2_0_InterCityBackboneCapacity<2M	Bandwidth (Mbps)	NLS4_0_BGC Mobile_Access_Collect_Voice NLS4_0_BGC MobileSwitchedVoice_transport_National_offnet NLS4_0_FixedSwitchedVoice_transport_National_offnet NLS4_0_ISDN-PRA_access NLS4_0_MobileTerminatingLinks
NLS2_0_InterCityBackboneCapacity=2M	Bandwidth (Mbps)	NLS4_0_ISDN-PRA_access
NLS2_0_InterCityBackboneCapacity>2M	Bandwidth (Mbps)	NLS4_0_BroadcastTV
NLS2_0_IntraAreaBackboneCapacity=2M	Bandwidth (Mbps)	NLS4_0_BGC Mobile_Access_Collect_Voice NLS4_0_BroadcastTV NLS4_0_ISDN-PRA_access
NLS2_0_IntraAreaBackboneCapacity>2M	Bandwidth (Mbps)	NLS4_0_BroadcastTV
NLS2_0_IntrazonalBackboneCapacity<2M	Bandwidth (Mbps)	NLS4_0_BGC Mobile_Access_Collect_Voice NLS4_0_FixedSwitchedVoice_transport_National_offnet NLS4_0_ISDN-PRA_access NLS4_0_MobileTerminatingLinks NLS4_0_PSTN_access
NLS2_0_IntrazonalBackboneCapacity=2M	Bandwidth (Mbps)	NLS4_0_BGC Mobile_Access_Collect_Voice NLS4_0_ISDN-PRA_access NLS4_0_MobileTerminatingLinks
NLS2_0_LocalBackboneCapacity<2M	Bandwidth (Mbps)	NLS4_0_BGC Mobile_Access_Collect_Voice NLS4_0_BGC MobileSwitchedVoice_transport_National_offnet NLS4_0_FixedSwitchedVoice_transport_National_offnet NLS4_0_MobileTerminatingLinks NLS4_0_PSTN_access
NLS2_0_LocalBackboneCapacity=2M	Bandwidth (Mbps)	NLS4_0_BGC Mobile_Access_Collect_Voice NLS4_0_ISDN-PRA_access NLS4_0_MobileTerminatingLinks

<u>NLS2_0_LocalBackboneCapacity>2M</u>	Bandwidth (Mbps)	NLS4_0_BroadcastTV
<u>NLS2_0_LocalTail<2M</u>	Number_of_customer_sites	NLS4_0_FixedSwitchedVoice_transport_National_offnet
<u>NLS2_0_LocalTail=2M</u>	Number_of_customer_sites	NLS4_0_FixedSwitchedVoice_transport_National_offnet
		NLS4_0_ISDN-PRA_access

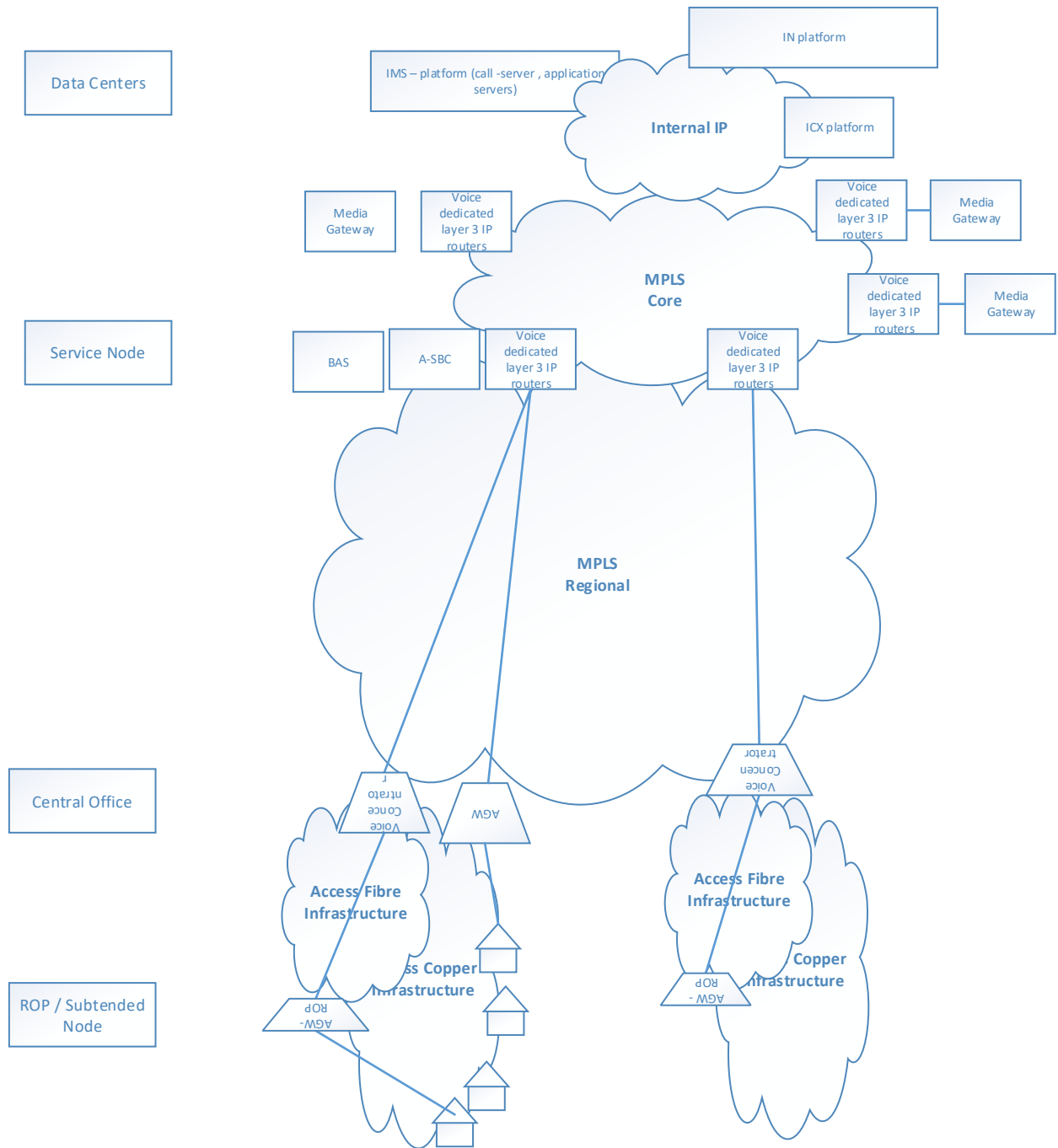

Figure 11: Fixed Voice NGN Network

8 Annex I: SCF Flow Acronyms

SCF	Support and Customer Flow
BIPT	Belgian Institute for Postal services and Telecommunications
BTN	Business Transformation
CBU	Consumer Business Unit
CC	Costs Center
CCG	Costs Center Group
CP	Costs Pool
CWS	Carrier & WholeSale
CUO	Customer Operations
DIY	Do It Yourself
EBU	Enterprise Business Unit
FAC	Fully Allocated Costs
HCA	Historical Cost Accounting
HMC	Human Manpower Cost
MOS	Material Out of Stock
NRA	National Regulatory Authority
REG	(Proximus) Group Regulatory Affairs
SMP	Significant Market Power
SOG	Services & Other Goods
S&S	Staff & Support

9 Annex II: Network and IT Flows Acronyms

AC	Asset Class
ADSL	Asymmetric Digital Subscriber Line
ATM	Asynchronous Transfer Mode
BA	Basic Access
BAS	Broadband Access Server
BES	Proximus European Solutions
BGC	Proximus
BILAN	Proximus Interconnection of LANs
BLES	Proximus LAN Extension Service
BROBA	Proximus Reference Offer for Bitstream Access
BROTSOLL	Proximus Reference Offer for Terminating Segment of Leased Line
BVAS	Business Value Added Services
CAE	Coverage Exchange Area
CAPEX	CApital Expenditures
CP	Cost Pool
CPE	Customer Premises Equipment
CPU	Central Processing Unit
CWDM	Coarse Wavelength Division Multiplexing
DACS	Digital Analog Cross-connect System
DCN	Data Communication Network
DSL	Digital Subscriber Line
DSLAM	Digital Subscriber Line Access Multiplexer
DU	Dispatch Unit
DWDM	Dense Wavelength Division Multiplexing
EAA	Extra Access Area
EAL	Ethernet Access Line
EFM	Ethernet First Mile
ESS	Ethernet Service Switch
Ethane	ETHernet Aggregation NETwork
EUS	End User Service
FAC	Fully Allocated Costs

FIFA	Fast Internet Future Architecture
FTTC	Fiber To The Cabinet
FTTO	Fiber To The Office
Gb	Giga bit
Gbps	Giga bits per second
HW	HardWare
IAA	Intra Access Area
iDTV	interactive Digital TeleVision
IN	Intelligent Network
TCE	Telecom CostExpert
IO	In/Out
IP	Internet Protocol
IPVPN	Internet Protocol Virtual Private Network
ISAM	IP Subscriber Line Access Multiplexer
ISDN	Integrated Services Digital Network
LAN	Local Area Network
LDC	Local Distribution Center
LEX	Local Exchange
LL	Leased Line
LTE	Line Terminating Equipment
Mbit	Mega bit
MEO	Modern Equivalent Opex
MOLO	Mobile Other Licensed Operator
MPLS	MultiProtocol Label Switching
MSR	Multi Server Router
MUX	Multiplexer
MVAS	Mass Value Added Services
MWE	MicroWave Equipment
NE	Network Element
NGA	New Generation Access
NGN	New Generation Network
NLS	Network Layer Service
NTE	Network Terminating Equipment

NTP	Network Termination Point
NSF	Network Stage Function
OLO	Other Licensed Operator
OLTE	Optical Line Terminating Equipment
OPEX	OPERational Expenditure
OVH	Overhead
PDH	Plesiochronous Digital Hierarchy
PRA	Primary Access
PSTN	Public Switched Telephony Network
QoS	Quality of Service
RAM	Random Access Memory
ROP	Remote Optical Platform
SDH	Synchronous Digital Hierarchy
SDSL	Symmetric Digital Subscriber Line
STM	Synchronous Transport Module
TDM	Time Division Multiplexing
TV	TeleVision
VAS	Value Added Services
VDSL	Very high speed Digital Subscriber Line
VLAN	Virtual Local Area Network
VoD	Video on Demand
VoIP	Voice over Internet Protocol
VP	Virtual Path
VPLS	Virtual Private Local area network Service
VPN	Virtual Private Network
WDM	Wavelength Division Multiplexing
SDE	Service Delivery Engine
CUO	Customer Operations
CFE	Customer Field Force
TEC	Technology
NEO	Network Engineering & Operations
TSI	Technology, Strategy & Innovation
ITS	Information Technology Services

ARP Architecture, Road map & Program Office

SPC Services, Platforms & Cloud