

Belgacom Regulatory Cost Model

2012

General Description

Authors:

DECHEVRE Agnès

DE CEUSTER Luc

DESTAILLEUR Laurent

DIEU Peter

DOOMS Françoise

GABRIELS Niels

LINGURI Philippe

MEERSMAN Raf

PEETERS Patrick

ROOSE Dirk

VANDENPLAS Danny

TABLE OF CONTENTS

1	GENERAL DESCRIPTION	5
2	MODEL ALLOCATION STRUCTURE	7
3	COST BASE.....	11
3.1	Périmètre des coûts inclus dans le modèle	11
3.1.1	Coûts inclus dans le modèle.....	11
3.1.2	Coûts exclus du modèle.....	12
3.2	Cost regrouping	13
3.3	Organisation	14
3.4	Répartition du périmètre des coûts entre le flow SRW et le flow Network / IT	15
3.5	Assets revaluation.....	17
3.5.1	Decision tree.....	17
3.5.2	Methods used to reevaluate the network assets	17
3.5.2.1	Price Indexation.....	18
3.5.2.2	Inventory	19
3.5.2.3	Keep as it is.....	19
3.5.2.4	Index Based on a fixed PPC.....	19
3.5.2.5	Price Indexation for mobile assets.....	20
3.5.2.6	Asset valuation based on the Belgacom Reference Offer tariffs.....	20
3.5.2.6.1	Method background and rationale	20
3.5.2.6.2	Method description	20
3.5.2.6.3	Scope	20
3.5.2.6.4	Method implementation	21
3.5.2.6.5	Exceptions to the generic implementation	22
3.5.2.6.6	BIPT BRxx tariffs as base for asset valuation	23
3.5.2.6.6.1	BRUO	23
3.5.2.6.6.2	Blocks and tie cables	23
3.5.2.6.6.3	BROBA rental per end-user line.....	24
3.5.2.6.6.3.1	Active part	24
3.5.2.6.6.3.2	Transport rental ATM.....	24
3.5.2.6.6.4	BROBA ATM transport.....	24
3.5.2.6.6.5	BROTSoLL (access line only)	25
3.5.2.6.6.6	WBA VDSL2 end user line.....	25
3.5.2.6.6.6.1	Passive part	25
3.5.2.6.6.6.2	Active part	25

3.5.2.6.6.7	WBA transport	25
3.5.2.6.6.8	BROTSoLL Ethernet	26
3.5.2.6.6.8.1	BROTSoLL Ethernet model for 1 Gbps lines	27
3.5.2.6.7	Transport PDH/SDH valuation	27
3.5.2.6.8	Non regulated tariffs as base for asset valuation	27
3.5.2.6.8.1	Adapted unicast price model for multicast	27
3.5.2.6.8.2	Local Tail Explore	28
3.5.2.6.8.3	Incremental intercity model	28
3.5.2.6.9	ATM equipment asset valuation	28
3.5.2.6.9.1	CAPEX Costing of the VP switching component	29
3.5.2.6.9.1.1	Elimination of IT, Overhead and backhaul components in BIPT tariffs	29
3.5.2.6.9.1.2	Calculation of ATM costs (CAPEX & OPEX)	34
3.5.2.6.9.1.3	Elimination of ATM OPEX costs	34
3.5.2.6.9.2	CAPEX Costing of the ATM access component	34
3.5.3	TAM: Tilted Annuity Method	34
3.5.3.1	Theory	34
4	SRW STREAM	37
4.1	Allocation of the support costs	37
4.2	Allocation of Retail costs	38
4.2.1	Determination of the retail cost perimeter	38
4.2.2	Retail cost allocation	39
4.2.2.1	Introduction of 2 cost type attributes	39
4.2.2.2	Criteria for Attribute dimension VAR_TYPE	39
4.2.2.3	Criteria for attribute dimension PS_TYPE	40
4.2.3	Retail allocation process	40
4.2.3.1	Allocation of organisational group costs (block 1)	40
4.2.3.1.1	Consumer Business Unit Organisational group allocation	42
4.2.3.1.1.1	CBU non CCA organizational group allocation	42
4.2.3.1.1.2	CBU CCA organizational group allocation	42
4.2.3.1.2	Enterprise Business Unit Organisational group allocation	43
4.2.3.2	Allocation of retail support costs (block 2)	43
4.2.3.3	Retail costs which do not have a causal relationship with products (block 3)	44
4.2.3.4	Retail costs with causal relation to products (block 4)	45
4.2.3.5	Graphical view on retail allocation flow	46
4.3	Allocation of CWS (Customer Whole Sale Division) related costs	47
4.3.1	Determination of the CWS cost perimeter	47
4.3.2	WholeSale cost allocation	48

4.3.2.1	Introduction of 2 cost type attributes	48
4.3.2.2	Criteria for Attribute dimension VAR_TYPE.....	48
4.3.2.3	Criteria for attribute dimension PS_TYPE.....	49
4.3.3	Wholesale allocation process.....	49
4.3.3.1	Allocation of organisational group costs (block 1)	49
4.3.3.1.1	Customer WholeSale Unit Organisational group allocation (2011)	50
4.3.3.2	Allocation of WholeSale support costs (block 2).....	50
4.3.3.1	Wholesale costs which do not have a causal relationship with products (block 3).....	51
4.3.3.2	Wholesale costs with causal relation to products (block 4).....	51
4.3.3.3	Graphical view on Wholesale allocation flow.....	52
5	SDE OPEX (NETWORK&IT) STREAM	54
5.1.1	Determination of the SDE cost perimeter	54
5.2.1	GL61 accounts – Services and Other Goods (SOG).....	61
5.2.2	GL60 accounts – Material Out of Stock.....	62
6	IT STREAM.....	64
6.1	IT delivery	64
6.1.1	IT allocation flow : Introduction	64
6.1.2	Data sources: IT Inventories and Reporting Systems:.....	65
6.1.3	Modules and Objects composing the IT allocation flow	66
6.1.4	Allocation Process for IT Assets and Operational Costs:	68
6.1.5	Applications to Markets.....	78
6.1.6	Projects to Markets	79
6.1.7	Allocation to Markets of IT costs that are common to several Markets :.....	79
7	NETWORK STREAM	80
7.1	A layered allocation model.....	80
7.2	From Assets to Network Stage Functions.	84
7.3	End User Services.....	90
7.4	Network services of the passive infrastructure layer : NLS1.0.....	91
7.4.1	Definition.....	92
7.4.2	Usage of the passive infrastructure	93
7.4.3	Contributors to the passive infrastructure layer	94
7.4.3.1	Access	94
7.4.3.2	Backbone	95
7.5	Network services of the transmission infrastructure (NLS2_0)	96
7.5.1	Definition.....	96
7.5.2	Usage of the transmission infrastructure	97
7.5.3	Contributors to the transmission infrastructure	99

7.5.3.1	Local Tail	99
7.5.3.2	Transport Segments.....	99
7.6	Network services of the packet based infrastructure (NLS2_1)	100
7.6.1	Definition	100
7.6.2	Usage of the data packet infrastructure	101
7.6.3	Contributors to the data packet infrastructure services.....	103
7.7	Network services of the IP infrastructure layer (NLS3-IP).....	106
7.7.1	Scope.....	106
7.7.1.1	Public services.....	106
7.7.1.1.1	IP_collection.....	106
7.7.1.1.2	Public_IP_switching	107
7.7.1.2	Private services.....	107
7.7.1.2.1	Private_IP&Ethernet_Extension	107
7.7.1.2.2	NLS3_Private_IP&Ethernet_Routing.....	108
7.7.2	Contributors to the Network Layer 3 services	109
7.8	Network Services of the application layer	112
7.8.1	Definition	112
7.8.2	Usage of the application layer	114
7.8.3	Contributors to the application services	124
8	ANNEX I: SRW FLOW ACRONYMS	130
9	ANNEX II: NETWORK AND IT FLOWS ACRONYMS.....	131

1 General description

Le département REG (Group Regulatory Affairs) assure la préparation des comptes séparés et opère le modèle d'élaboration des coûts sous-jacent à la production des coûts séparés et utilisé dans différents autres dossiers réglementaires. Conformément aux recommandations de la Commission Européenne, la totalité des coûts issus de la comptabilité générale (statutaire) est prise en compte dans le cadre de l'élaboration des comptes séparés et du modèle de coûts sous-jacent, à l'exception des comptes 65 à 68 et des coûts des autres comptes écartés du périmètre. Les coûts utilisés dans l'exercice de modélisation sont directement issus du système SAP qui administre la comptabilité générale de Belgacom S.A. Les comptes statutaires ont fait l'objet d'un audit statutaire en 2013 effectué par Deloitte, Réviseurs d'Entreprises. Le collège des réviseurs d'entreprises a émis une attestation sans réserve des comptes annuels.

Les comptes séparés émanent des flux d'allocation de coûts réseau, IT et des flux SRW (Support, Retail and Wholesale) du système de comptabilisation des coûts de Belgacom, incluant le périmètre issu de la comptabilité générale ainsi que le coût du capital repris dans ces deux modules.

Le schéma suivant représente la structure du système de comptabilisation des coûts et mentionne les flux principaux. L'entièreté des éléments de coûts présents dans les flux est intégrée dans un logiciel (INCA) qui en effectuant des tests de validations empêche toute possibilité de double comptage ou d'attribution multiple.

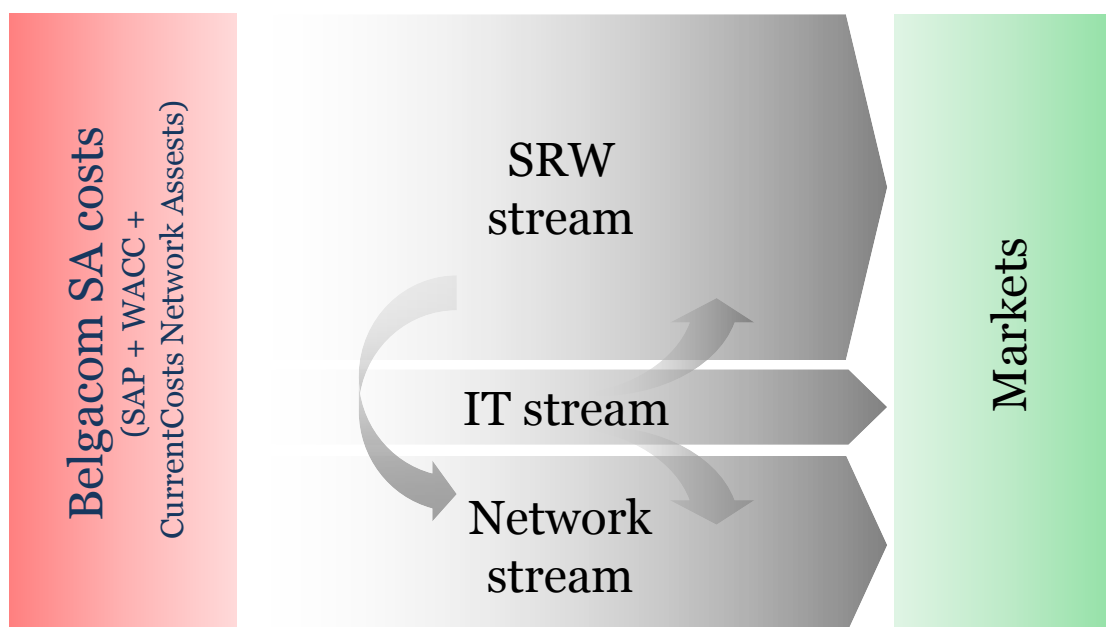

Figure 1

Les flux d'allocation de type SRW reprennent les coûts commerciaux et les autres coûts directs ou indirects qui ne sont pas repris dans les flux d'allocation « réseau » ni dans les flux « IT ».

Les flux « réseau » et les flux « IT » quant à eux , traitent tous les coûts en matière de réseau et de technologie de l'information.

Faisant partie d'un seul et même modèle intégré et prenant leur source à une seule base de coûts , les flux d'allocation « SRW » , « réseau » et « IT » sont vérifiés par l'outil de gestion de modèle INCA assurant l'absence de double comptage et la traçabilité des données calculées jusqu'aux données du système SAP.

Le modèle d'élaboration des coûts de revient par marché suit l'approche "top-down".

2 Model Allocation Structure

This section provides with a global view on the allocation structure of the model by walking through the major allocation flows and introducing the major building blocks and concepts in the model.

The following Figures will be the supporting tools for such discovery walk, where the major modules constituting the model as well as the global allocation flows among them are shown. The differentiation between SRW , IT and Network flows is also illustrated in the exhibit.

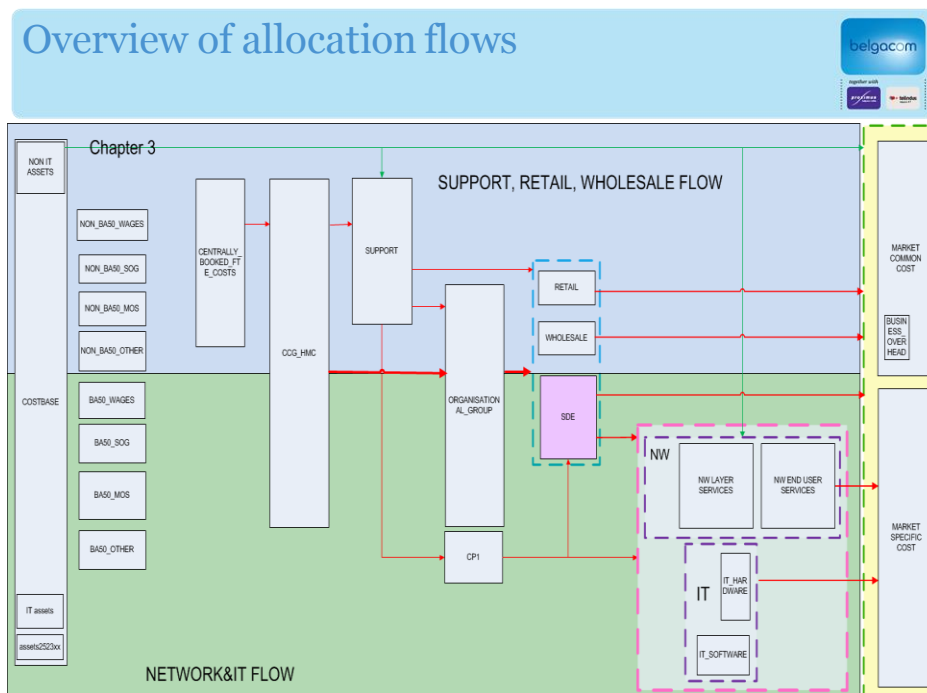

Overview of allocation flows

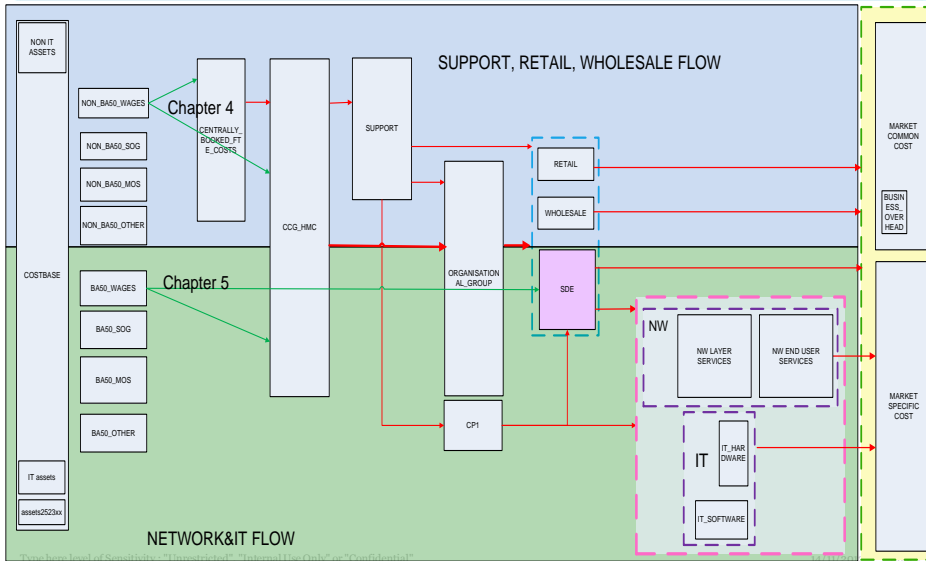

Overview of allocation flows

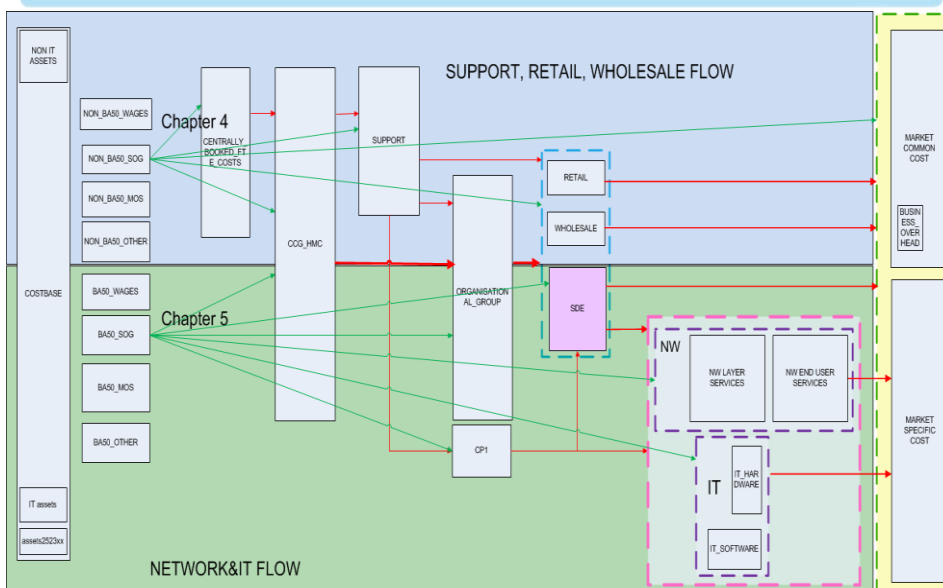

Overview of allocation flows

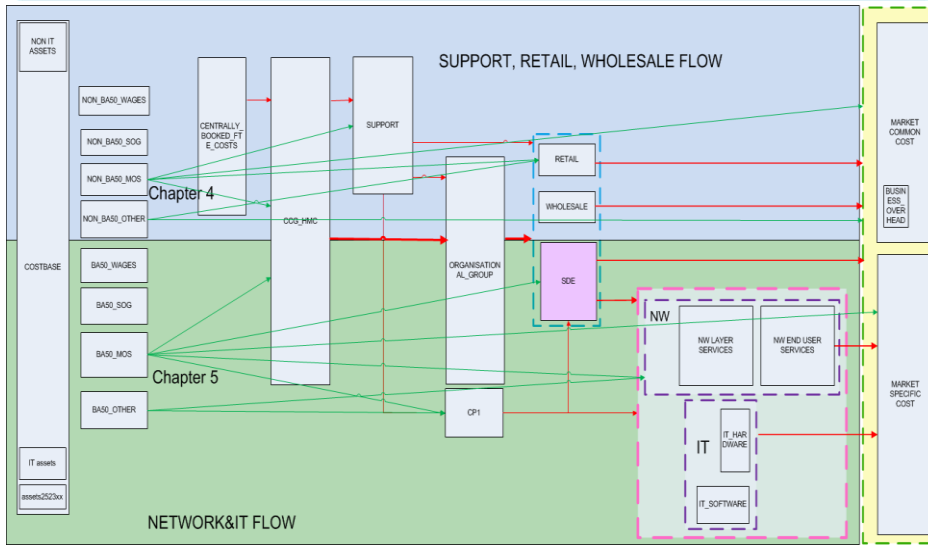

Type here level of Sensitivity: "Unrestricted", "Internal Use Only" or "Confidential"

15/11/2012 Slide 4

Overview of allocation flows

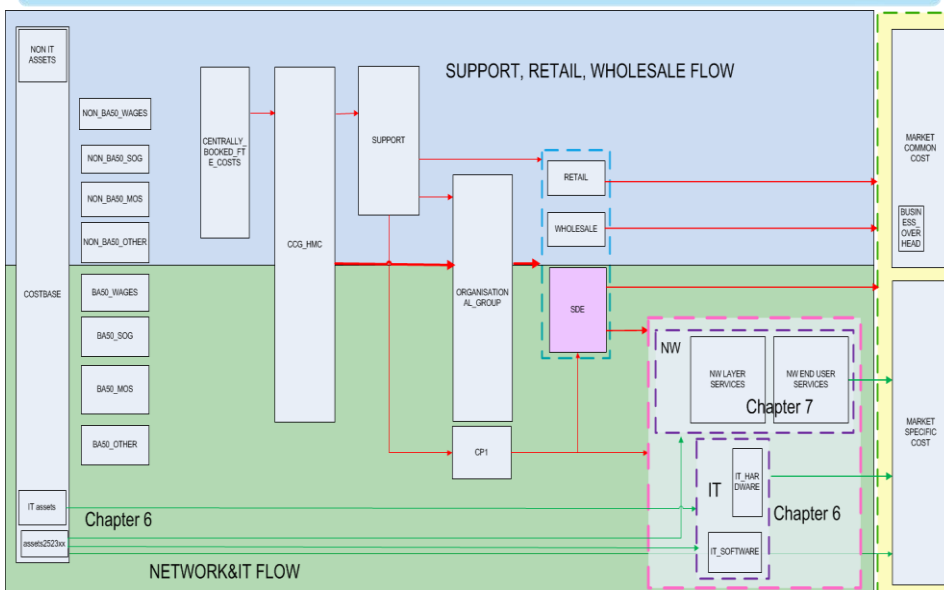

The overall objective of the model is allocating all the attributable costs present in the cost base to the markets as defined in the regulatory framework.

Therefore, the cost base constitutes the foundation of the model.

Further, the model allocation process can be subdivided into three main streams, SRW, IT and Network.

The SRW stream has as objective to allocate all costs that are not part of the Network or IT model towards the markets.

The IT and Network streams, although having completely separated CAPEX basis, both share a common OPEX source.

Once this has been discussed (chapter 5), the IT stream (chapter 6) and Network stream (chapter 7) can be dealt with independently.

3 Cost Base

3.1 Périmètre des coûts inclus dans le modèle

3.1.1 Coûts inclus dans le modèle

Les coûts inclus dans le modèle sont les comptes de charges opérationnelles, c'est à dire les comptes 60 à 64 de la comptabilité générale, ainsi qu'une partie du compte 69.

Le compte 60 "achats de matériel" comprend principalement des achats de matériel télécom (modem ADSL, terminaux, câbles, cartes, mobiles, ...) et de fournitures (cpe, ...) et des variations de stocks.

Le compte 61 "services et biens divers" comprend principalement les charges liées au trafic (notamment les redevances d'interconnexion) et les charges de maintenance, d'énergie, de locations, de publicité, de représentation, de consultants, de déplacements.

Le compte 62 correspond aux charges de personnel.

Le compte 63 correspond aux dotations aux amortissements, aux provisions et aux réductions de valeur.

Le compte 64 regroupe les autres charges opérationnelles, parmi lesquelles se retrouvent principalement les éléments suivants : abandons de créances, précompte immobilier et taxes sur pylones.

Le compte 69 reprend le montant d'affectations et prélèvements correspondant à la participation du personnel dans le bénéfice de l'exercice (bonus collectif).

Par ailleurs, le compte 72 – "Production immobilisée" vient diminuer la base des coûts pour annuler les charges liées à la production immobilisée et éviter un double comptage avec les charges d'amortissements correspondantes.

Au périmètre issu de la comptabilité générale s'ajoute le coût moyen pondéré du capital (WACC) de 9,61% pour Belgacom fixe et 10,05% pour Belgacom mobile.

Pour l'année 2012, la matérialité des coûts inclus dans le modèle (hors "coût moyen pondéré du capital" qui ne provient pas directement de la comptabilité) est la suivante :

60 Materials out of stock
61 Services & other goods
62 Remunerations, social security and pensions
63 Depreciations, write offs and accruals
64 Other operating charges
69 Appropriation
72 PFA
Total costs

Tableau 1: Matérialité des charges incluses dans le modèle de coûts de revient

(en EUR et en % du total des charges)

However in the Cost Base we have almost 10.500 lines with « zeros » or with "almost zeros" within a same CCG_CP combination (coming from transfers between GL accounts). The total amount of these lines is 6 EURO. For practical reasons these lines will not be loaded up in the model tool INCA.

Consequently the total cost included in the model is (Confidential) EURO

Au périmètre issu de la comptabilité générale s'ajoute le coût moyen pondéré du capital (WACC) de 9,61% sur le FIXE et de 10,05% sur le MOBILE.

Ainsi, la base totale de coûts traitée en entrée du modèle s'élève en 2012 à (Confidential) MEUR en coûts historiques.

Suite aux ajustements liés au passage des coûts historiques aux coûts courants qui sont effectués pour les coûts réseau, on arrive à une base totale de coûts en entrée du modèle (comptabilisation des coûts et comptes séparés) de l'ordre de (Confidential) MEUR en coûts courants.

3.1.2 Coûts exclus du modèle

Les autres charges sont exclues du modèle. Il s'agit des comptes 65 à 69 de la comptabilité générale, excepté une partie du compte 69.

Certaines charges sont exclues car considérées comme n'ayant pas de lien de causalité avec les produits et les activités. C'est le cas des charges exceptionnelles (compte 66) et des charges fiscales (comptes 67 et 68).

D'autres charges sont exclues du fait qu'elles sont déjà prises en compte dans le coût moyen pondéré du capital. Il s'agit des charges financières (compte 65) et des charges de dividendes (compte 69).

Il s'agit ici des coûts exclus du modèle en amont (c-à-d. lors de la délimitation du périmètre de coûts issus de la comptabilité générale) auxquels il faudra ajouter les coûts qui sont exclus en aval du modèle (c-à-d. lors du processus d'allocation, par exemple les coûts de support relatifs aux filiales).

Pour l'année 2012, la matérialité de ces coûts est la suivante :

65 financial Charges	
66 Extraordinary charges	
67 Income taxes	
68 Transfer to deferred taxes and untaxed reserves	
69 Appropriation	
Total costs excluded	

Tableau 2: Matérialité des charges exclues du modèle des coûts de revient

(en EUR et en % du total des charges)

3.2 Cost regrouping

Belgacom enregistre les coûts d'une part sur un compte défini dans la comptabilité générale et d'autre part sur un centre de coûts défini dans la comptabilité analytique. Cette étape a pour objectif d'agréger ces données afin de simplifier la manipulation de ces données.

Deux types de regroupement sont effectués :

- celui des 687 comptes de la comptabilité générale en 200 cost pools et
- celui des 633 centres de coûts en 364 groupes de centres de coûts.

Un **cost pool** est un groupe de coûts qui ont des caractéristiques communes et sont issus de la même famille de nature de coûts.

Dans le cas de ressources matérielles, seront regroupés les coûts qui remplissent une fonction similaire. Ainsi, le cost pool "Dépenses en formation" regroupe les coûts de formations organisées par Belgacom pour son staff, les coûts de séminaires extérieurs et les coûts de magazines, de livres et de documentation liés aux formations.

En ce qui concerne les ressources humaines, seront rassemblés les coûts des travailleurs qui ont le même profil. Ainsi, le cost pool "Level S" reprend les salaires des employés de niveau S (force de vente) ainsi que les primes et contributions allouées à ces travailleurs.

Les coûts repris dans un même cost pool ont une relation de causalité identique avec les activités ou les produits auxquels ils peuvent être attribués, ils ont le même "resource driver".

Un **groupe de centres de coûts** regroupe des centres de coûts qui ont des caractéristiques communes et qui réalisent des activités similaires. Par exemple, les centres de coûts représentant un point de vente particulier sont repris sous le groupe des centres de coûts des points de vente en général (p.ex. le point de vente de Wavre appartient au groupe de centres de coûts "points de vente" car tous les points de vente réalisent le même type d'activités et peuvent donc être regroupés au sein d'un même groupe).

Chaque groupe de centres de coûts consomme les différents cost pools. En effet, le point de vente de Wavre emploie des employés de niveau S. Dès lors le groupe de centres de coûts "points de vente" regroupera la « consommation » en employés de niveau S de l'ensemble des points de vente.

Ainsi, les combinaisons cost pool/groupe de centres de coûts forment des groupes de ressources. Ce sont ces groupes de ressources qui constituent la base de coûts du modèle.

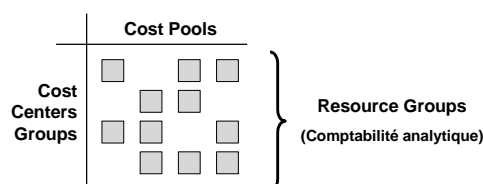

Groupes de ressources

3.3 Organisation

In 2012 the main change was the reorganisation of SDE where all IT applications and services were put into a new ITS department called Information Technology Services. Business Transformation (BTN) and Program Office (POP) were brought together in an APP department called Architecture, Planning and program offices. New departments were created like NEO (Network Engineering & Operations) and CIS (customer ICT Services) out of the existing ones SDV (Solution Development), IDO (Infrastructure Deployment & Field Operations) and SIO (Service Center & Remote Infrastr. Operations). All this in the perspective to improve customer's experience and to work more efficiently.

Within CBU the IMU (Integrated Media Unit) activities were integrated within BED (BGC Entertainment Division). The EBS department (E-Business Services) was integrated within SLS (Sales). New departments were created, i.e. PS (Products & Solutions) and SPV (Strategic planning & Value Mgmt) formerly part of MKT (Marketing) and MKT became MKC (Marketing & Content).

There are small changes within S&S where the COM department disappears. Internal communication went to GHR (Group Human Resources) and Group Communication is integrated within GPA (Group Public Affairs). Also the CSE (Corporate Sponsoring & Events) department disappears and is split over GHR, GPA and STR (Strategy) which changed from name in STC (Group Strategy & Content).

There was a new structure for BA_49 Supply Chain Mgmt with SRC (Sourcing) previously PRO (Procurement), COE (Center of excellence) and OPS (Operations) formerly LOG (Logistics).

The organisational structure is laying upon 4 pillars:

- Consumer Business Unit (CBU) has the responsibility over the residential customers
- Enterprise Business Unit (EBU) has the responsibility over the professional customers
- Service Delivery Engine (SDE) centralises wholesale, network and IT services
- Staff and support (S&S) groups all horizontal functions sustaining the Group activities

For information, find below the organisation as on December 31, 2012 :

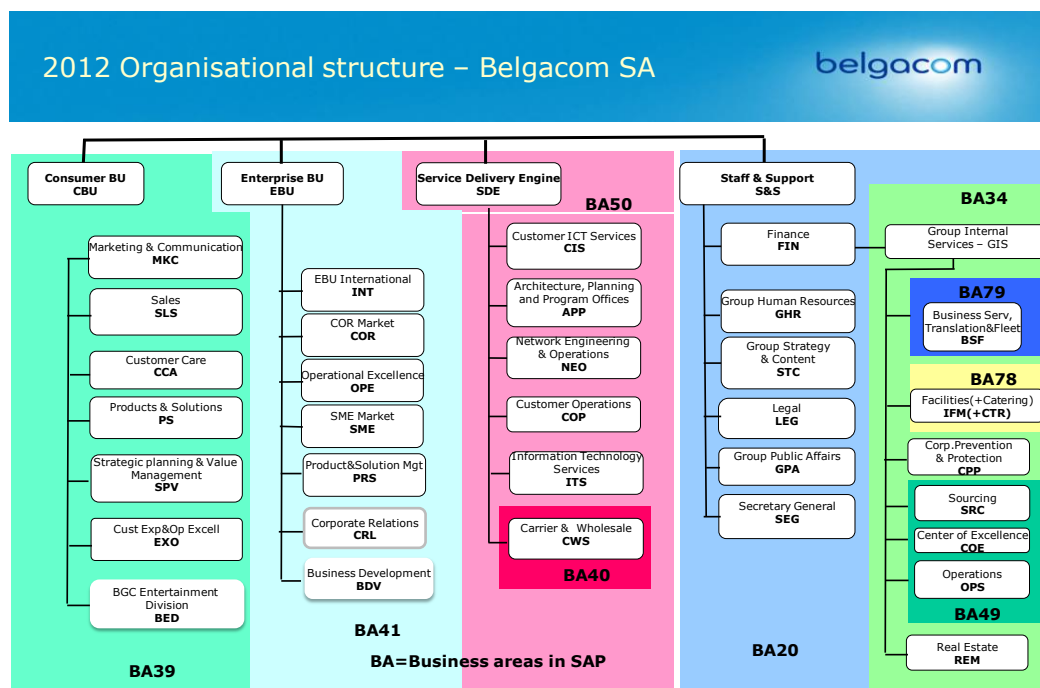

Figure 2

- This organisation has a clear split between the residential and professional customers by creating the division Consumer and Enterprise Business Units.
- The Service Delivery Engine brings together Network and IT services , Customer Operations (COP) and Carrier Wholesale (CWS).
- Within Staff & Support the content (FIN, GHR, STC, LEG, GPA....) remains the same. Group Internal Services grouping internal services like Fleet, Facilities, Prevention&Protection, Sourcing... falls under the responsibility of FIN, the Financial department.

3.4 Répartition du périmètre des coûts entre le flow SRW et le flow Network / IT

Le périmètre des coûts est réparti par le département REG entre les flux d'allocation de coûts réseau, IT et SRW en s'assurant que les données de coûts issues de SAP soient complètes et ne contiennent pas de doublons. Comme mentionné dans la description générale, le flux Network / IT alloue tous les coûts et investissements en matière d'informatique et de réseau alors que le flux SRW alloue tous les autres coûts et investissements.

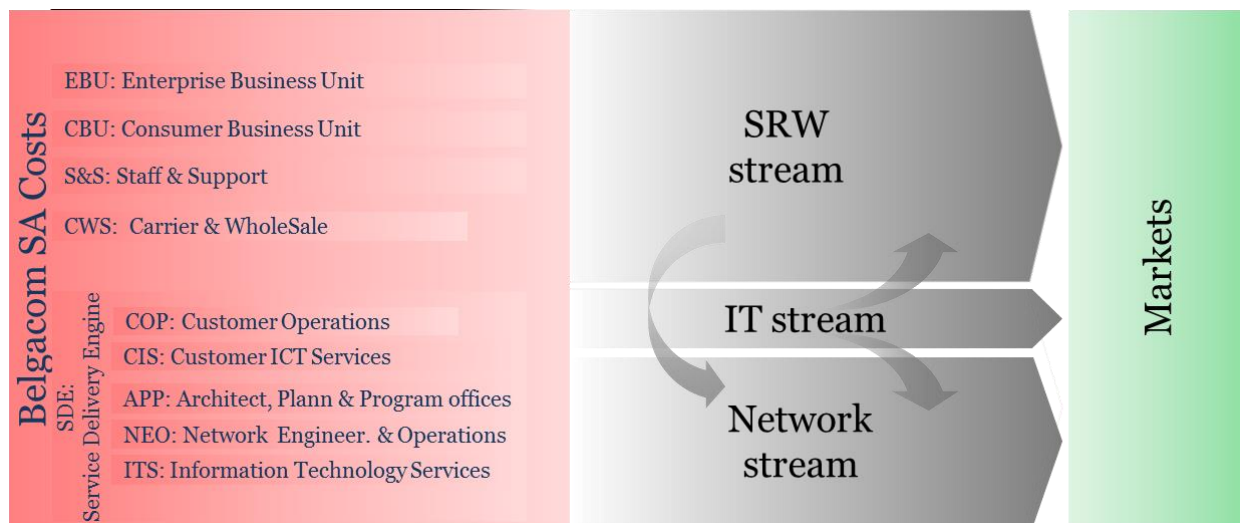

Figure 3

La répartition du périmètre des coûts entre les flux Network / IT et SRW est réalisée comme suit:

- All departments within SDE are treated within the Network / IT flow.
- Les provisions relatives aux taxes sur équipements télécom qui sont enregistrées au niveau de SDE Mgmt sont réparties entre les flux sur base des classes d'actifs sous-jacentes.
- All other costs, not mentioned above are treated within the SRW flow namely the divisions CBU (Consumer Business Unit) and EBU (Enterprise Business Unit), CWS (Carrier Wholesale) and Staff & Support. The Staff & Support division comprises different departments. Firstly, STB (Services to Business) which includes Headquarters, Legal, Group Public Affairs and Secretary General. Then we have departments like Finance, Group Human Resources, Group Strategy & Content and GIS (Group Internal Services) for departments like Real Estate, Business Services, Facilities, Prevention & Protection, CSM (Corporate Sourcing & Supply Change).
- En ce qui concerne les investissements (amortissements et coût moyen pondéré du capital), la répartition entre les flux SRW et Network / IT est effectuée sur base d'une analyse des classes d'actifs: les actifs IT et réseau enregistrés au niveau de la division SDE sont traités dans le flux Network / IT tandis que tous les autres actifs (bâtiments, installations énergie, CPE,...) sont traités dans le flux SRW.

3.5 Assets revaluation

3.5.1 Decision tree

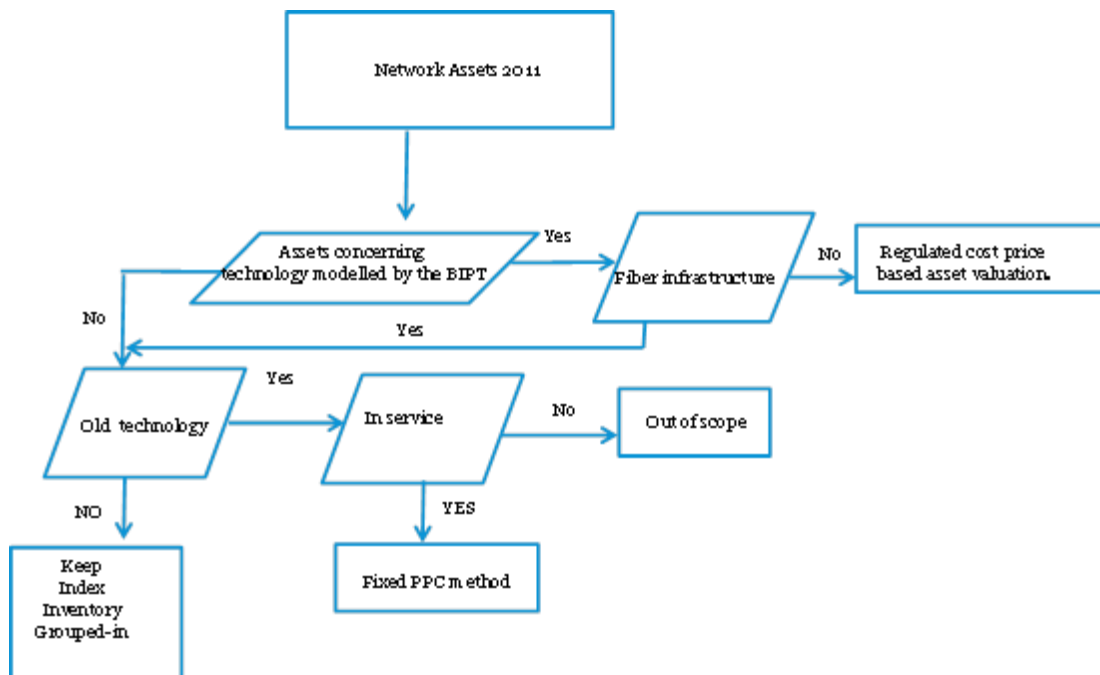

3.5.2 Methods used to revalue the network assets

The regulatory framework clearly states that the cost accounting systems of operators being declared as dominant on relevant markets must be set based on Current cost accounting for the network costs.

The network & IT flows within the top down model 2012 calculate the current costs for the network related assets. Current costs have been computed as explained hereafter.

There are five methods to evaluate the current value of the network: reassessment of the current inventory, price indexation, by default “keep everything as it is”, index based on a fixed PPC and regulated cost price based. For old assets concerning technology still in service we use a method based on a fixed PPC2007. Each of these methods requires its own set of inputs. It is mainly the availability (or lack) of input which dictates the choice of the method. Nevertheless each method has its advantages and disadvantages with respect to the others.

The inventory and price indexation methods assume that network departments replace the equipment of its assets by equivalent equipment. The notion of equivalent is quite fuzzy. An engineer would tell you that over time there are always more functions integrated in new equipment and that they are always more cost-effective. It makes the comparison between different generations of equipment difficult. The notion of equivalent has therefore been addressed through the term Modern Equivalent Asset (MEA). The assets must be replaced by their MEA. The MEA is the replacement cost of the technology expected to be in place within the planning horizon. Note that this notion takes into account the introduction speed of a new technology in the network. If network departments plan to have replaced 50% of an old technology by a new one within the planning horizon, it makes no sense to simulate the costs with higher percentages because the planning takes into account the availability of the resources to carry out the work.

Find hereafter the rules that have been used:

- Technology still in procurement: use current price, e.g. SDH equipment, DWDM equipment
- Technology to be replaced within the planning horizon: use current price of the modern equivalent asset, e.g. some PDH line system equipments are replaced by SDH equivalents.
- Obsolete technology: use current price of the modern equivalent asset, e.g. the HDSL technology for high speed services on copper replaces the less cost-effective HDB3 technology.
- Technology grouped in : those assets will be revaluated by another asset concerning the same technology
- Old technology not anymore in service : those assets are set out of scope and will not be revaluated
- Old technology still in service (in maintenance mode) ; those assets are revaluated by an index method based on a fixed PPC instead of index or inventory method . Old assets revaluated by keep will keep the CAV value as GRC
- BIPT regulated technology : use the BIPT regulated cost price to calculate the annual capital cost

3.5.2.1 Price Indexation

This is the most straightforward approach, provided historical costs are available. The investments for each year (from 1981 on) are multiplied by the price index of the year concerned. The price index is equal to the ratio of the current price to the historical price of the equivalent service/product.

The method is refined by defining price indexes depending on the nature of the cost. This is particularly true when costs of a different nature experienced a different price evolution. Three different types of price indices have been defined: the labour index, the indices for services delivered by external companies and the material index. Note that indices for services supplied by external companies vary according to the asset involved. For example, services supplied by external companies related to cable assets, are in fact outsourced labour costs for trenching and cable

installation. In such case, a labour index has been applied. Other external services less labour intensive are resulting in other price indices, such as a fibre cable index.

3.5.2.2 Inventory

This is the best method to reflect accurately the price of assets currently in service in the network. The revaluation is merely performed by multiplying the volume of each specific type of equipment currently deployed in the network by its average current unit cost. The current unit costs are based on the prices defined in the current frame agreements we have with our suppliers.

In terms of inputs it is the most demanding method. It requires an extensive inventory of equipment.

The inventory method has been used for data, switching, transmission and access equipment. Switching data is based on the inventory reports delivered by the engineering service. Transmission and access data are obtained from the technical database ITR. Data inventories are obtained from field operational tracking sheets.

3.5.2.3 Keep as it is.

The “keep as it is” method is merely what its name says. We keep the price we have in the historical accounting books. This method is only valid for costs with a very short depreciation period or for software intensive products. For the latter we assume that on the one hand software development is labour intensive but on the other hand the rapidly evolving programming environment improves the productivity compensating for the higher labour cost. This results in a stable software price. Another practical reason to select the “Keep as it is” method is the amount booked on the asset. If this amount is small, the method has also been applied. In this particular case, the effort to collect all the information about the cost evolution outweighs the impact on the service costs.

3.5.2.4 Index Based on a fixed PPC

Old technology still in service (in maintenance mode) ; those assets are revaluated by an index method based on a fixed PPC.

If Belgacom has done some investments for keeping those technologies in service, we take those investments also into account.

If Belgacom has done some great retirements, the revaluation method is revised.

□ Formula :

$$GRC_{yearN} = [(GRC_{yearN-1}) * (1 + fixedPPC\ 2007)] + investments_{YearN}$$

3.5.2.5 Price Indexation for mobile assets

The investments for each year are multiplied by the price index of the year concerned. The price index is equal to the ratio of the current price to the historical price of the equivalent service/product.

The historical series of indexes for each asset has been derived from the yearly percentage price change determined in the **BIPT model 2008**.

Formula :

Index year = (1+ (ppc year))* (1+(ppc year -1))* (1+(ppc year -2))*

3.5.2.6 Asset valuation based on the Belgacom Reference Offer tariffs

3.5.2.6.1 Method background and rationale

The market for fixed telecommunication services, the related technologies and the competition have evolved through the years leading to the current situation where the vast majority of the telecom services provided by the Belgacom's access and area backbone networks are regulated. This regulation has been enforced, amongst other initiatives, by clearly specifying the services and applying regulated tariffs, as reflected in the Belgacom Reference Offers (BRUO, BROBA, BROTSOLL, BROTSOLL Ethernet and WBA).

Since the regulated tariffs are cost oriented and determined by bottom-up costing models, it is reasonable to use the direct CAPEX component of these prices to calculate the annuity of the assets addressed by the Belgacom Reference Offers.

3.5.2.6.2 Method description

All the assets, except optical fiber infrastructure, concerned by the technologies covered by the Belgacom Reference Offer models (BRxx), namely BRUO, Block&Tie cables, BROBA, BROTSOLL, BROTSOLL Ethernet and WBA, are valued by applying the direct CAPEX component of the relevant BRxx tariff to the appropriate volumes extracted from the Belgacom inventories.

3.5.2.6.3 Scope

The technologies to be valued by this method, since they are covered by the Belgacom Reference Offers, are:

- Copper infrastructure: including trenching, ducting and copper cable.
- (D)WDM
- PDH/SDH
- ATM
- xDSL: including ADSL, ADSL2+ and SDSL
- VDSL
- Ethernet

However, some parts of the networks deployed with the above mentioned technologies are not covered by the BIPT tariffs for they provide non regulated services. Consequently they cannot be valued by means of the regulated tariffs.

These services are:

- Any service provided by the Belgacom express network layer, also called intercity network.
- Multicast services, namely broadcast TV.
- Access lines for the Explore customers.

The chosen alternative for valuing the network sections providing the non regulated services has been the development of specific models in order to determine applicable direct CAPEX unit prices.

3.5.2.6.4 Method implementation

- *Inputs*

- *Broken down tariffs*

- *Broken down tariff based on the BIPT BRxx models*

By analyzing each of the current BRxx models, the direct CAPEX component of each product of each tariff has been isolated. Further, this constituent has been broken down into all its applicable technological contributors, so that a unit price per technology, per product and per tariff is extracted (Figure 4: Conceptual description of the BRxx tariff breakdown.).

Although the above described process is applicable to the majority of the BRxx models, there is an exception to the rule, the BIPT BROBA transport model. A complete explanation on how this tariff is broken down, in order to obtain the direct CAPEX component, is given in paragraph 3.5.2.6.9.

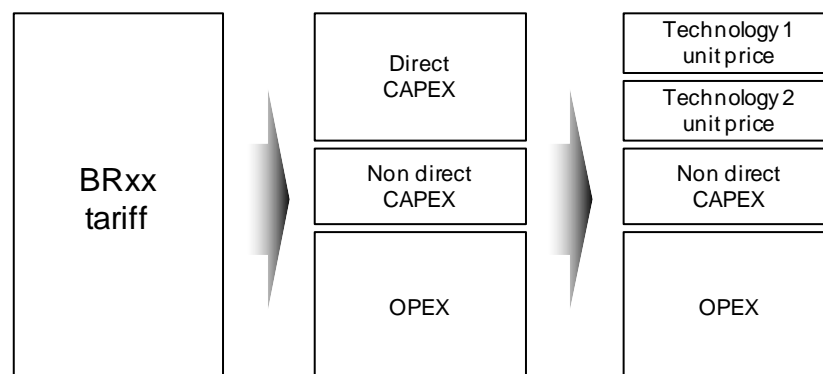

Figure 4: Conceptual description of the BRxx tariff breakdown.

Note: There is no relation between the size of the components and any broken down BRxx tariff.

- *Broken down tariff for network areas not under the BIPT BRxx models scope*

For those areas of the network not within the scope of the BIPT models, specific models have been developed in order to derive applicable broken down tariffs. These models have been built up on similar principles to those applied in the models developed by the BIPT. Whenever possible the actual BIPT tariff components have been re-used and existing BIPT models have been adjusted so that the obtained results are as comparable to those of the BIPT models as possible.

- *Volumes*

The volumes (demands) of all the telecommunication services utilizing the technologies subject to this valuation methodology are extracted from or determined based on Belgacom inventory systems.

• **Valuation**

- In a first step, each pair, line, VP, link or VLAN present in the volumes is valued by applying each and all of the technology unit prices of the relevant BRxx tariff. In this way, each telecom service’s individual contribution to the assets valuation is calculated.
- Finally, all the individual contributions are summarized per network asset, obtaining the final asset annuity.

3.5.2.6.5 Exceptions to the generic implementation

Although the above described process is applicable to the majority of the tariffs and related technologies, there are two exceptions to the rule.

The breakdown of the BIPT BROBA transport tariff is made differently. A complete explanation on how this tariff is broken down, in order to obtain the direct CAPEX component, and how it is applied is given in paragraph 3.5.2.6.9.

The valuation of the transport SDH/PDH assets implementing the regulated part of the Belgacom’s SDH network, although based on the BIPT’s BROTSoLL model, do not follow the above described generic process. The used methodology is described under the paragraph “Updated BROTSoLL model to the 2012 demand”.

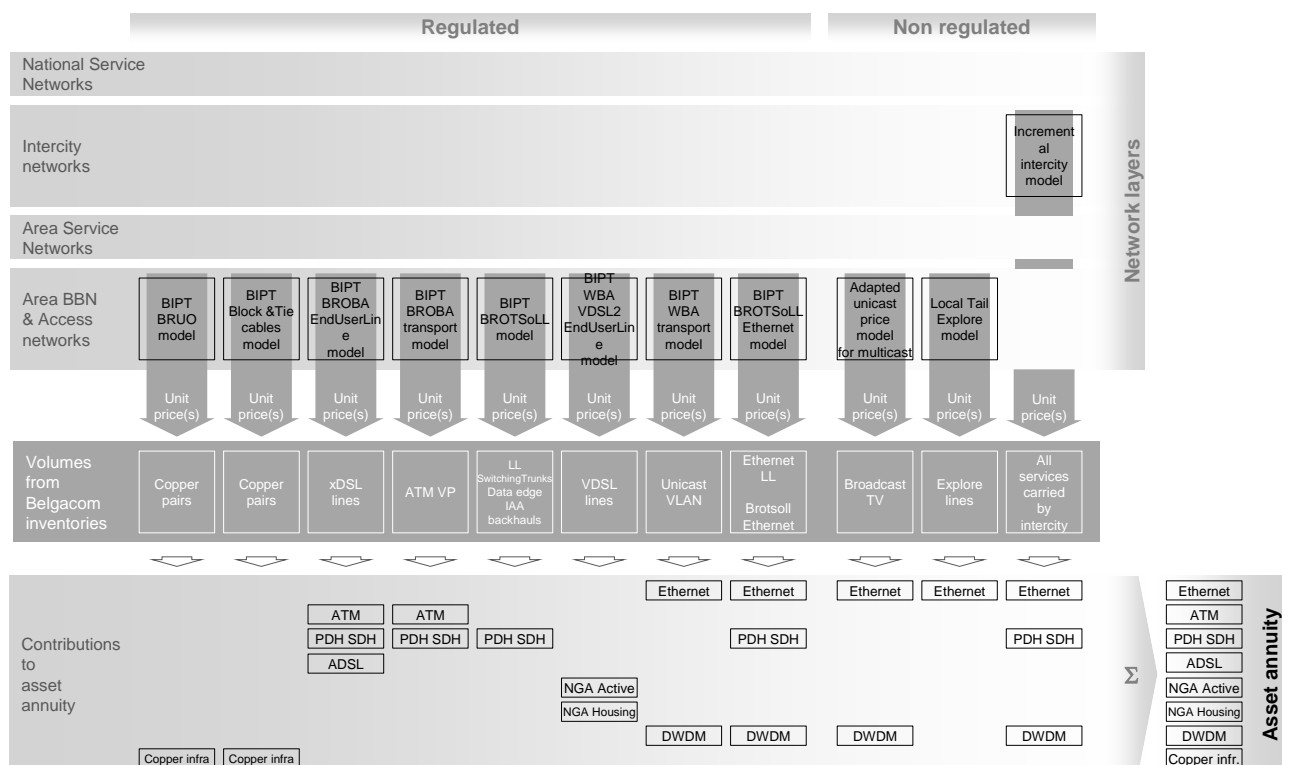

Figure 5: BRxx based valuation method. Scope and implementation.

3.5.2.6.6 BIPT BRxx tariffs as base for asset valuation

3.5.2.6.6.1 BRUO

The BIPT BRUO model (decision of 9/11/2011) has been used to value assets included in the asset AC2_20104 Copper infrastructure. These assets have been valued based on the unit direct CAPEX cost in the BRUO model and the number of pairs used. It mainly includes the cost of copper cables, trenching and street cabinets and covers the copper distribution and copper feeding networks.

The yearly direct CAPEX cost of the following assets has been calculated based on BRUO tariffs:

- Raw Copper for PSTN/ISDN accesses, central site based broadband without voice accesses, local tails for leased lines type of connectivity, BRUO raw copper.
- Copper subloop, for ROP based VDSL connections without voice accesses.
- Copper subloop testing cost, to ensure remote line testing of ROP based VDSL connections without voice accesses. This cost is valued based on the unit direct CAPEX cost of the feeding network that can be derived from the BRUO tariffs (local loop, subloop).

In the frame of a possible fixed/variable analysis of the results of the model, copper distribution and feeding network costs are categorized as fixed. It should be noted that this has no impact on the results of the model itself.

Our analysis is based on the approach used by BIPT and its consultant, Analysys Mason, for the development of an NGN/NGA model. The dimensioning of the copper distribution and feeding network is dependant on the evolution of the number of households, reflecting the universal service obligation of Belgacom. The evolution of the number of copper pairs actually used by customers subscriptions or internal usage, has no impact on the total copper access investment cost calculated by the BIPT NGN/NGA model. Copper access (distribution and feeding) is a fixed cost, with no causality of the volume of copper pairs actually used.

Its allocation method could be based on the market value of the different products using the network. However, in order to be conform with the approach used by BIPT in the BRUO/BROBA reference offers, we have attributed the copper access network cost towards the different en-user services and markets based on the number of consumed copper pairs.

The cost of the copper splitters, to split narrowband and broadband signals for shared pairs has been valued based on the shared pairs inventory.

3.5.2.6.6.2 Blocks and tie cables

The BIPT Blocks and Tie cable model (decision 2/7/2008) has been used to value assets included in the asset AC2_20104 Copper infrastructure. This bottom-up model defines direct CAPEX prices for Main Distribution Frame blocks and for tie cables to other access network equipments.

The current value of following assets has been calculated based on Blocks and Tie cable tariffs:

- Copper local loop testing: internal cabling for copper connectivity to perform remote testing of broadband customer connections without voice accesses based at the central site.
- Copper subloop testing: internal cabling for copper connectivity of ROP based VDSL customer connections without voice accesses.
- Continue raw copper and shared feeding pairs: internal cabling for copper connectivity from the Main Distribution Frame or broadband splitter equipment to other access equipments or collocated access equipments.

3.5.2.6.6.3 BROBA rental per end-user line

The BROBA rental fee per end-user line is split by BIPT between the active part and the transport rental ATM or Ethernet part. This model is sometimes referred to as BROBA Bitstream.

3.5.2.6.6.3.1 Active part

The BROBA model (decision of 6/8/2010) has been used to value assets included in AC2_20102 ADSL equipment. It is related to DSLAM and Main Distribution Frame space yearly direct CAPEX costs.

The asset has been calculated based on the direct CAPEX part of the BROBA Bitstream tariff applied to ADSL, ADSL2+ and SDSL subscription volumes.

3.5.2.6.6.3.2 Transport rental ATM

Transport rental ATM refers to the cost of the backhaul line between the DSLAM and the ATM switch. These links are implemented as ATM over PDH/SDH which in turn is carried by the optical fiber infrastructure, therefore the cost is constituted by the following elements:

- ATM (AC2_20103 ATM equipment): it is valued as per BROBA transport description on paragraph 3.5.2.6.9.

3.5.2.6.6.4 BROBA ATM transport

This model regulates the service delivering ATM connectivity (virtual paths) between ATM switches. As mentioned in the former paragraph, the ATM services are always deployed as ATM over SDH, thus the following costs constituents emanate from this model:

- ATM cost

This cost relates to the function of the ATM network to provide switched Virtual Paths between a port of a local switch and another port of the same local switch (local VPs) or of an area switch (non local VPs). It is integrated in AC2_20103 ATM equipment.

This costing is based on the demand for xDSL (ADSL, ADSL2+ and SDSL) fast internet accesses and on the inventory of switched Virtual paths (local VPs, and non-local VPs) configured on the Belgacom ATM network, for all other virtual paths. Each virtual path is valued using the current BIPT BROBA VP tariffs (decision of 22/10/2008).

For xDSL fast internet accesses, the demand has been calculated based on the inventory of customers and DSLAMs per local exchange. Given the customer profile and the associated

constant average usage (kb/sec), the total required bandwidth per virtual path ATM has been calculated.

The complete description of this tariff component, its calculation and use is given on paragraph 3.5.2.6.9.

3.5.2.6.6.5 BROTSoLL (access line only)

The Belgacom Reference Offer for Terminating Segments of Leased Lines (BROTSoLL) regulates the complete PDH/SDH transmission network of Belgacom, with the exception of the highest hierarchy rings, the so called Intercity network or express layer. The current BIPT decision on this tariff dates from 10/3/2008.

Note that for the 2012 model the below explanation is only applicable to the valuation of the access lines to BROTSoLL services. The valuation of the transport costs has been done as described in the paragraph "Transport PDH/SDH valuation". The technologies covered by this reference offer and consequently to be valued through this tariff are:

- PDH/SDH : covering the costs of the access line equipment of this technology.

Further, this service can in fact make use of the copper infrastructure on the access side in case of small bandwidth lines. However, these costs are embedded in the BRUO based valuation.

The SDH access line valuation has been done by applying the above technologies direct CAPEX unit cost to all the links implemented over SDH under the BROTSoLL and BROTSoLL Ethernet over SDH scope which are documented in ITR, the Belgacom transmission inventory system.

3.5.2.6.6.6 WBA VDSL2 end user line

3.5.2.6.6.6.1 Passive part

The BIPT WBA model (decision 10/11/2010) has been used to value the assets AC2_20108 NGA Housing as well as part of the asset AC2_20106 fibre infrastructure related to external fiber connectivity to the cabinet (ROP ; Remote Optical Platform).

For the valuation of AC2_20108 NGA Housing, the BIPT unit direct CAPEX cost has been applied to the number of VDSL2 subscriptions. The main elements included are the cost of the ROP, the copper connectivity between the ROP and the street cabinet and power equipments.

3.5.2.6.6.6.2 Active part

The asset AC2_20107 NGA Active equipment has been valued based on the related BIPT direct CAPEX cost.

It is mainly related to the IP DSLAM installed in the ROP or in the local site, the equipment to aggregate the fibre cables connecting the ROP to the local exchange ("aggregators"), as well as the internal cabling and block positions on the optical main distribution frame (OMDF).

3.5.2.6.6.7 WBA transport

WBA transport regulates the transport of Ethernet based data (unicast VLANs), covering the complete Belgacom Ethernet/MPLS network, with the exception of the highest hierarchy level, the Intercity network or express layer. The current BIPT decision on this pricing dates from 6/8/2010.

The Ethernet data, grouped in VLANs, is directly carried on densely multiplexed optical wavelengths over optical fiber. Thus, the technologies to be valued via this model are:

- Ethernet (AC2_20105 ethernet equipment): values the ethernet routers and switches allowing the transport of Ethernet data within an ethernet area.
- DWDM (AC2_20101 (D)WDM equipment): covers the cost of the Dense Wavelength Division Multiplex network that, together with the fibre infrastructure, brings the physical connectivity amongst the Ethernet equipments.

In order to obtain the value of each of the above technological components, the direct CAPEX unit costs for the different technologies have been applied to the unicast VLANs implemented on the MPLS network. For each VLAN, the peak bandwidth is determined. This peak bandwidth :

- equals the ordered bandwidth (for Broba and E-line for OLO) or
- is determined on basis of number (and type of consumption) of subscribers and sizing rules (for FI, VoIP, VoD) or
- is estimated on basis of the ordered bandwidth and measurements on the ethernet equipments (relative to the service like IP-VPN, E-line)

The peak bandwidth is then distributed over the different (relevant) priority bits.

3.5.2.6.6.8 *BROTSoLL Ethernet*

Being a special case of BROTSoLL, the services within the BROTSoLL Ethernet scope are the dedicated transparent Ethernet connections. The current BIPT decision on this tariff dates from 10/3/2008.

In principle these lines are implemented as Ethernet over SDH. However, due to the rather large bandwidth typical to this type of services -10 Mbps, 100 Mbps or 1Gbps- this implementation is neither always possible nor efficient. Therefore we distinguish two main technical executions:

- Ethernet over SDH: for the 10 or 100 Mbps lines, also named Ethernet and Fast Ethernet respectively
- Ethernet over DWDM: for the 1 Gbps or Gigabit Ethernet lines, where the DWDM wavelength is dedicated to the line. Note that no SDH equipment is used in this case.

Ethernet over DWDM: for the 1 Gbps or Gigabit Ethernet lines, where the DWDM wavelength is dedicated to the line. Note that no SDH equipment is used in this case.

The Ethernet over SDH services require SDH and optical fiber for their implementation. Therefore, and following the 2012 model logic, the SDH costs incurred by the implementation of such services will be valued by the “Updated BROTSoLL model to the 2012 demand”. The optical fiber costs are not valued by the BRxx method anymore.

Regarding the Ethernet over DWDM services, due to the lack of a BIPT model backing up the regulated tariff, Belgacom has developed a simple model in order to arrive to a valid cost oriented tariff for asset valuation purposes (see the below sub-paragraph for further details on the development of this model). This tariff contributes to the valuation of the DWDM and optical fiber asset. Nevertheless, the DWDM tariff component will be the only one used by the BRxx valuation method since the fiber is not valued by this method in the 2012 model.

Finally, the only cost component valued by this method within BROTSoLL Ethernet is the DWDM. The valuation has been done by applying the DWDM direct CAPEX unit cost to all the links implemented over DWDM under the BROTSoLL Ethernet scope which are documented in ITR, the Belgacom transmission inventory system.

3.5.2.6.6.8.1 BROTSoLL Ethernet model for 1 Gbps lines

Transport tariff component

Given the fact that the lines subject to be valued by this model are dedicated DWDM wavelengths to the BROTSoLL Ethernet line, the average tariff is constituted by:

- the actual cost of a kilometer of DWDM wavelength according to the Belgacom Regulatory Cost Model 2009.
- the cost of a Km optical fiber infrastructure, according to BROTSoLL.

Finally, this average cost per kilometer of wavelength has been annualized and de-averaged to obtain a tariff per distance ranges as that of the regulated tariff.

Access tariff component

The access tariffs are the same as in BROTSoLL.

3.5.2.6.7 Transport PDH/SDH valuation

The present BROTSoLL model is based on the Belgacom SDH services inventory belonging to 2005. From 2005 until now the utilization of the SDH services has changed and new services consuming large bandwidth, typically Brotsoll Ethernet and the like products, have been implemented over SDH. These new services would alter the distribution of services per bandwidth, putting an extra weight on the higher bandwidths, imposing changes in the network dimensioned by the BROTSoLL calculation sheets which in turn will incur in (non linear) costs changes.

Therefore, in order to incorporate a more realistic SDH cost in the model, it was decided to re-play the current BROTSoLL model with the 2012 SDH services demand.

In order to do so, the relevant files of the cumbersome BROTSoLL model have been consolidated into two streamlined files that easily allow the dimensioning and costing of the required SDH network for any given demand.

Then the set of all the SDH based services running on the Belgacom network at the end of the year 2012 (all the links implemented over SDH under the BROTSoLL and BROTSoLL Ethernet over SDH scope which are documented in ITR) was entered into the new consolidated transport BROTSoLL engine and the resulting SDH costs represent the value of the PDH/SDH asset in the 2012 model.

3.5.2.6.8 Non regulated tariffs as base for asset valuation

3.5.2.6.8.1 Adapted unicast price model for multicast

The only multicast service currently carried by the Belgacom's network is BroadcastTV. Since the VLAN used by this service is shared by all the Belgacom TV customers, the VoD shared VLAN tariff could initially be contemplated as tariff.

However, the maximum bandwidth this VLAN can reach is reserved for multicast services, while the bandwidth of the unicast VLANs –within the WBA transport scope- cannot be reserved. Hence, the unicast VLAN tariff is not applicable anymore.

This bandwidth reservation characteristic needs to be valued, for it represents a disadvantage, a reduction of the overall available bandwidth, for the unicast VLANs coexisting in the same physical medium. Since the reserved bandwidth for multicast is one fifth of the physical medium bandwidth (maximum 2 Gbps multicast traffic over the 10 Gbps bandwidth of the DWDM bandwidth), the multicast tariff used for valuation purposes is five times that of the unicast.

As this model is an adaptation of the WBA transport model, it contributes to the same assets as the WBA transport:

- Ethernet
- DWDM

The valuation of the assets consumed by this service is calculated by applying the direct CAPEX tariff components to all the configured multicast VLANs in the network.

3.5.2.6.8.2 Local Tail Explore

Local Tail Explore refers to the access line, this is to say the set of equipments and infrastructure entailed to provide the connectivity between the customer and the Belgacom network, the Explore customers require. Given that Explore is not a regulated product and has specific technical requirements that are not contemplated by any of the existing BIPT models, a new model needed to be developed to cost this segment.

In fact the model is very straightforward since it just consists of isolating the few different components in the offered technical solutions and applying their respective annualized costs. Since the infrastructure components present in this model have already been valued by existing BIPT models, the regulated direct CAPEX unit costs have been applied to them.

The only asset in which this model participates is Ethernet.

In principle, this model should also contribute to the Copper infrastructure, since there is a technical solution on copper, however this asset valuation component is fully taken into consideration by the valuation based on the BRUO model.

The valuation has been done by applying the fitting direct CAPEX technology to all access lines to Explore services documented in ITR, the Belgacom transmission inventory system.

3.5.2.6.8.3 Incremental intercity model

This model is an incremental inventory based model that covers the cost of the equipment and infrastructure deploying the express layer of the network.

It is incremental since only the extra costs incurred in the implementation of such intercity network are taken into account.

Further, for it is an inventory based model, inventories of all the technologies present at the intercity level, namely DWDM, SDH and Ethernet, were gathered. Then the corresponding gross replacement costs have been applied and annualized arriving to the total gross replacement costs per technology of the intercity network.

3.5.2.6.9 ATM equipment asset valuation

The valuation of the ATM asset has been aligned with the BIPT BROBA model.

In the ATM network architecture two levels of ATM switches are present: the local ATM switch, and the area level ATM switch, the area level nodes correspond to the interconnect areas used in BRIO, BROBA and BROTSOLL. The function of the ATM network is to provide switched Virtual Paths between a port of a local switch and another port of the same local switch (local VPs) or of an area switch (nonlocal VPs). For Virtual Path switching two equipments are involved: the ATM switches themselves (also called switching fabric), and the trunk interfaces to interconnect distant ATM switches. In order to access configured Virtual Paths, access interface equipments are needed at the border of the local or area switches.

The ATM asset contains the investment costs of the equipments delivering switched Virtual Paths (the ATM local switches, the ATM area switches, the ATM trunk interfaces for the backhaul links between the ATM switches) and the equipment delivering access to VPs (ATM interfaces for the ATM tributaries or clients).

The costing of the asset is thus decomposed in the costing of the VP switching equipment (backbone ATM equipment) and in the costing of the access to VP equipment.

3.5.2.6.9.1 CAPEX Costing of the VP switching component

This costing is based on the inventory of switched Virtual paths (local VPs and non-local VPs) configured on the Belgacom ATM network. Each virtual path is valued using the BIPT BROBA VP tariffs. Indeed, the BIPT tariffs are cost based and are established using a bottom-up costing model.

However, the BIPT tariffs being full cost tariffs, they integrate the ATM CAPEX, the ATM OPEX, the backhaul transmission costs (links between the ATM trunks interfaces), the IT costs and the overhead costs. Applying directly the BIPT BROBA tariffs would incorporate costs other than ATM CAPEX costs in the ATM asset. Therefore the costing is conducted in 3 steps:

The first step eliminates the IT, the overhead and the backhaul costs component from the BIPT tariff computing a tariff structure free of IT/overhead/backhaul. The second step applies this tariff to the inventory of VPs yielding a ATM cost containing ATM CAPEX and ATM OPEX. The third step calculates the OPEX costs corresponding to the network equipment amounts allowing the VPs of the inventory and subtracts this cost from the ATM CAPEX&OPEX. The end result is an estimation of the pure CAPEX cost for all configured VPs.

There are many advantages in using this approach; first, the BIPT BROBA tariffs per VP value complex VP characteristics like Quality of Service, Peak Cell Rate / Sustained Cell Rate ratio, distance aspect (local, nonlocal VPs) and VP capacity. Secondly, the BIPT tariffs also value other material costs directly involved in ATM like cabling investment costs and ATM management platform investment costs.

3.5.2.6.9.1.1 Elimination of IT, Overhead and backhaul components in BIPT tariffs

We used the Bottom-Up tariff calculation model of the BIPT where the IT, overhead and backhaul transmission components are easily identified and isolated. The IT and overhead are calculated via markup percentages (resp. 6% and 7%). These are easily eliminated from the Tariffs.

Further, the BIPT tariff parameters are the parameters of 4 linear regressions on 4 data sets (see "Besluit van de Raad van het BIPT van 22 oktober 2008 met betrekking tot de BROBA rental fee" pages 31-to-36):

- a calculated data series of total VP costs versus growing bandwidth for local VP with bandwidth $\leq 1\text{Mbs}$
- a calculated data series of total VP costs versus growing bandwidth for nonlocal VP with bandwidth $\leq 1\text{Mbs}$
- a calculated data series of total VP costs versus growing bandwidth for local VP with bandwidth $> 1\text{Mbs}$
- a calculated data series of total VP costs versus growing bandwidth for nonlocal VP with bandwidth $> 1\text{Mbs}$

We used the BIPT bottom-up model to derive VP backhaul costs for the same series of bandwidths and subtracted them from the total VP costs in order to produce the same 4 data sets as in the BIPT model but without IT, overhead and backhaul costs. The linear regression parameters on these data sets provide the cost price parameters for VP costs without IT, overhead and backhaul costs. The next exhibits compare the 4 BIPT cost data sets presented in the BIPT pricing decision document (“Besluit van de Raad van het BIPT van 22 oktober 2008 met betrekking tot de BROBA rental fee”), with the data sets free of IT, overhead and backhaul costs.

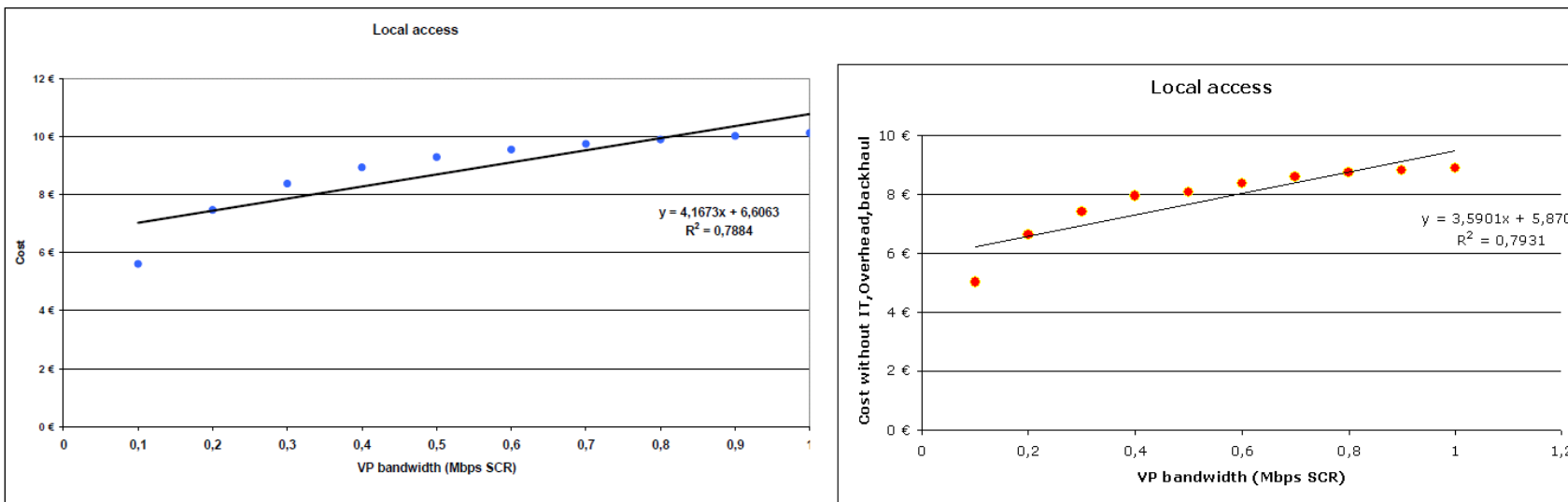

Figure 6: Local Access - Small bandwidth

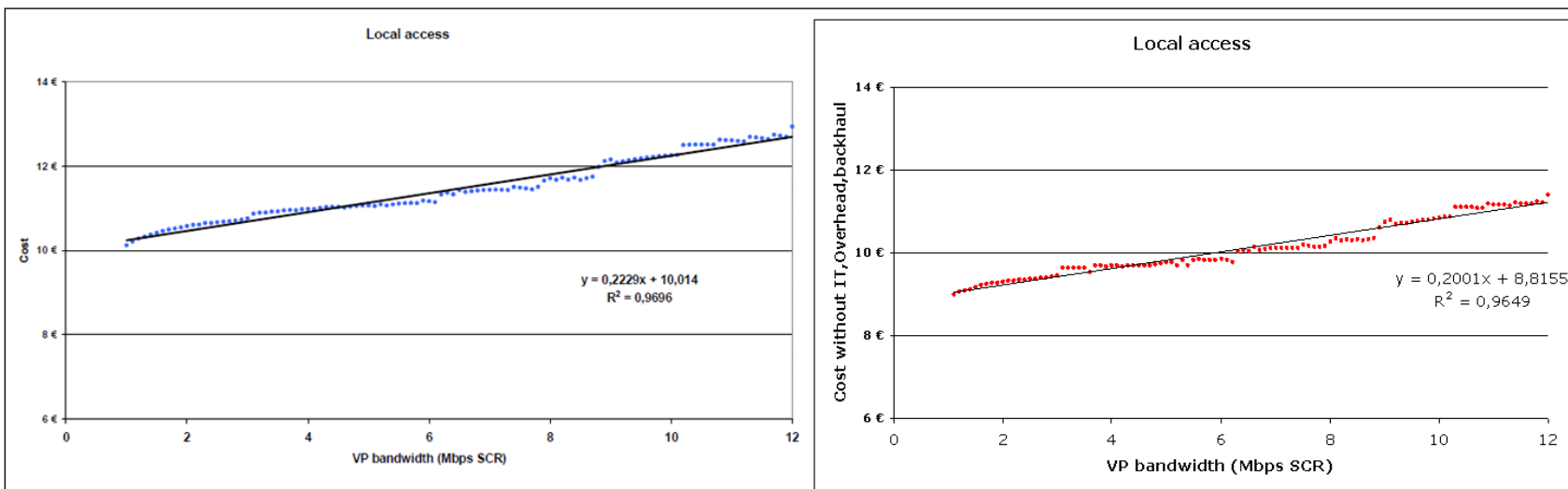

Figure 7: Local Access - Large bandwidth

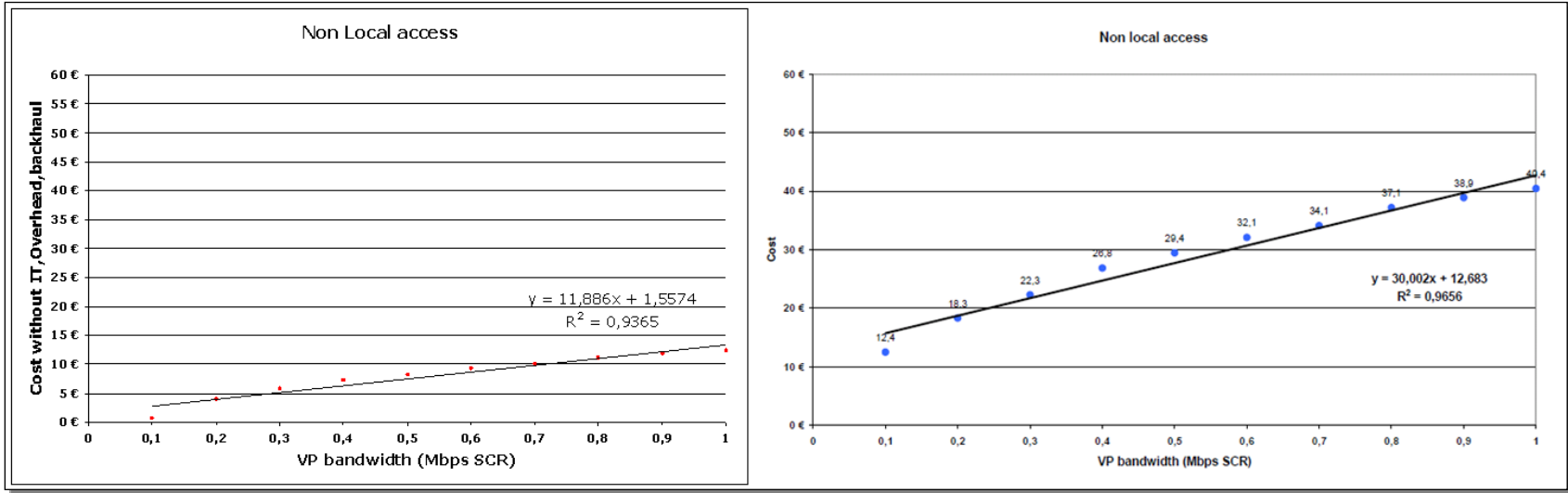

Figure 8: Non Local Access - Small bandwidth

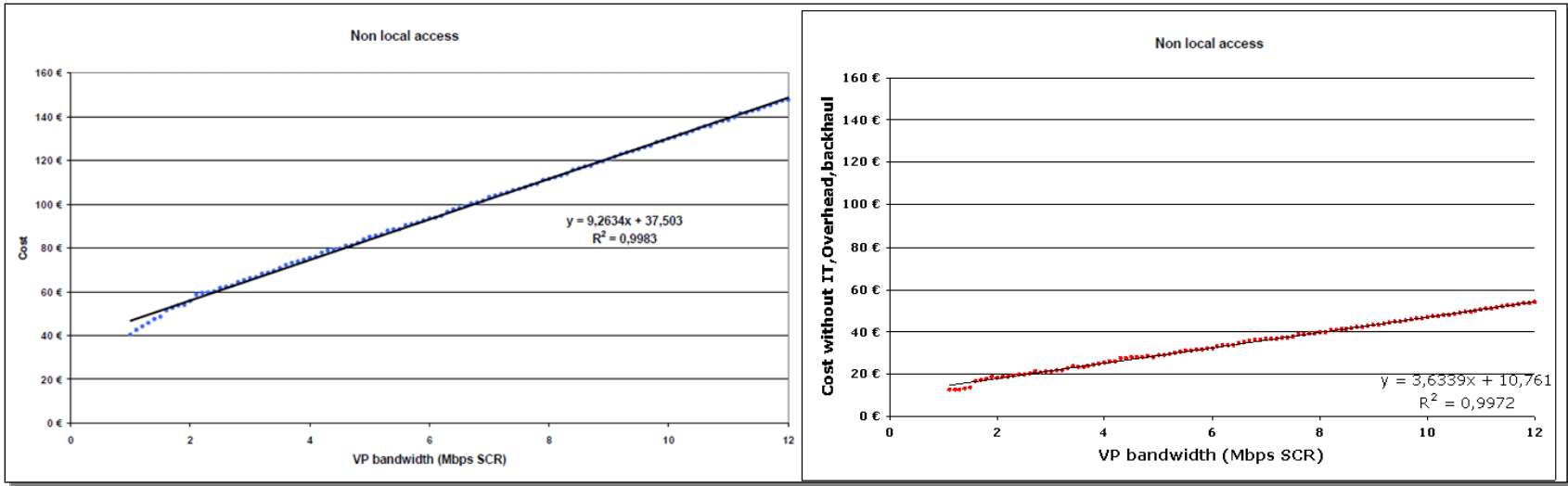
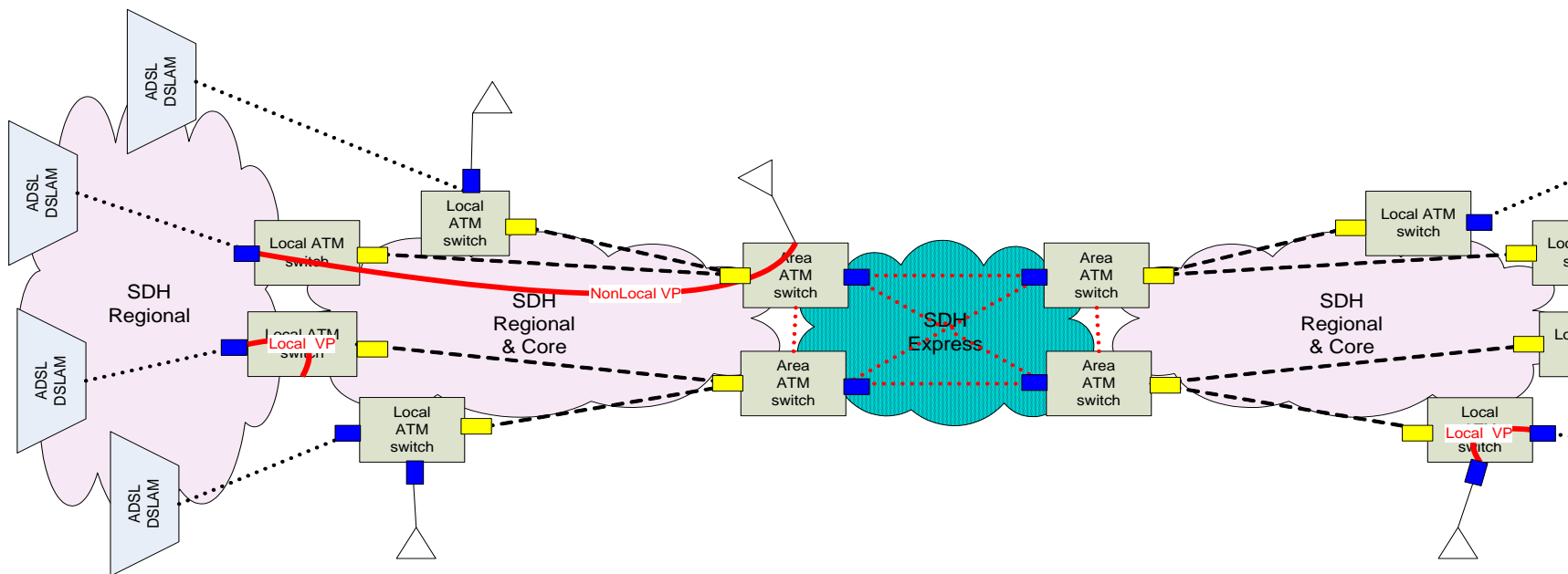

Figure 9: Non Local Access - Large bandwidth



Legend:

- DSLAM-ATM Backhaul links
- ATM-ATM Regional&Core Backhaul links
- ATM-ATM Express Backhaul links
- Access to ATM network
- NonLocal VP ATM Regional Virtual Path non local
- Local VP ATM Regional Virtual Path local
- ATM trunk interfaces (for links between regional ATM switches)

Figure 10 - ATM network

3.5.2.6.9.1.2 Calculation of ATM costs (CAPEX & OPEX)

The tariffs determined in previous step are free of IT, overhead and backhaul costs , in other words they correspond to the ATM CAPEX and OPEX costs . These tariffs are simply applied on the inventory of VPs configured on the Belgacom network yielding a total ATM CAPEX + OPEX cost.

3.5.2.6.9.1.3 Elimination of ATM OPEX costs

In the BIPT bottom-up model, the ATM OPEX costs depend on the amount of equipment deployed in the network, which itself depends on the network load (expressed as a load factor). Belgacom has estimated the network load factor of the BIPT model that best corresponds to the estimated traffic switched in all the VPs of Belgacom ATM network.

Afterwards, the ATM OPEX costs are calculated in the BIPT bottom-up model using that load factor.

The total ATM OPEX costs are subtracted from the total ATM CAPEX +OPEX costs determined in section 3.5.2.6.9.1.2, resulting in the ATM CAPEX cost. This final value is the yearly CAPEX costing of the VP switching component of the ATM asset.

3.5.2.6.9.2 CAPEX Costing of the ATM access component

The CAPEX costing of the ATM access component is based on the detailed inventory of access lines ending-up in ATM switches; the source of this inventory is the ITR infrastructure inventory system. Only the tributary lines are considered in this inventory as the accesses for ATM inter-switch links (trunks) are already valued in the VP switching component.

The same unit costs of ATM ports as in the BIPT Bottom-Up BROBA model are applied on this inventory depending on the capacity of tributary lines to come to the CAPEX costs of the ATM access component.

3.5.3 TAM: Tilted Annuity Method

3.5.3.1 Theory

The purpose of this section is to describe how the Tilted Annuity Method (TAM) is finally implemented in the Current Cost Accounting (CCA) based network cost model 2012.

As from the 2003 model, Belgacom implemented the formula that BIPT suggested.

$$ACC_{\mu Y} = F_{1, \mu Y} \times F_{2, \mu Y}$$

where

$$F_{1, \mu Y} = (GRC_{\mu Y, \text{begin}} + GRC_{\mu Y, \text{end}}) / 2$$

$$F_{2, \mu Y} = \sqrt{(1 + WACCY) \times [1 - (1 + APC_{\mu}) / (1 + WACCY)]} / [1 - [(1 + APC_{\mu}) / (1 + WACCY)]^{L_{\mu}}]$$

and where

- $ACC_{\mu Y}$: Annual CAPEX Cost of asset μ and year Y . It includes the annual depreciation and the cost of capital.
- $WACC_Y$: WACC of year Y .
- $GRC_{\mu Y, \text{begin}}$: Gross Replacement Cost of asset μ at the beginning of year Y .
- $GRC_{\mu Y, \text{end}}$: Gross Replacement Cost of asset μ at the end of year Y .
- APC_{μ} : Annual Price Change of asset μ .
- L_{μ} : Lifetime of asset μ .

Remarks:

The formula assumes that:

- In the beginning of year Y was invested in an asset and that at the middle of each year of the lifetime of the asset revenues will be generated.
- The annual price change is constant over the lifetime of the asset.
- The asset price does not evolve during the year, i.e. price changes only appear at January 1st.

The factor $F1_{\mu Y}$ represents the value of asset μ in the middle of year Y .

- The purpose of the arithmetic average of $GRC_{\mu Y, \text{begin}}$ and $GRC_{\mu Y, \text{end}}$ is to take into account investments or disinvestments of asset μ during the year Y .
- The arithmetic average of $GRC_{\mu Y, \text{begin}}$ and $GRC_{\mu Y, \text{end}}$ does not filter out the price evolution of the asset μ during the year Y .

The difference between the formula of BIPT and the formula of Exhibit 5, p. B3. of the white paper of Analysys is the factor $1 / \sqrt{1 + APC_{\mu}}$, which filters out the price evolution of the asset μ during the year Y .

The gross replacement cost (GRC) of assets at any particular point in time is calculated as the sum over all assets owned by the business at that point in time, of the investment that would be necessary to purchase and install new replacements for those assets at that point in time (using modern equivalent assets if the existing assets are no longer available or efficient). The replacement value of assets, used for costing purposes should always include the gross value of every asset in use by the business (the current cost of replacing it with a new, possibly modern equivalent asset), irrespective of the history of depreciation of that asset in any financial accounts to date.

L_{μ} : Lifetime of asset μ , i.e. the expected useful lifetime of the new asset μ .

The depreciation period and the expected useful lifetime of a new asset are defined differently. The depreciation period refers to accounting. The expected useful lifetime of a new asset does not refer to accounting. It refers to the period that is expected that a new asset will be used. The main factor to determine the expected useful lifetime of a new asset is the evolution of the associated operational costs, i.e. the asset will be replaced when operating it becomes too expensive. Another

factor is the appearance of new technology: if in the future new technology will come-up it could be that the asset will be replaced (even if it is not too expensive to operate).

Important remark :

This formula is applied for all network assets except for some assets related to radio access network. For these assets however, the assumption of a constant price trend over the lifetime period is inadequate because important negotiations for replacement of these assets and started during 2009 announce sharp and different price changes over short periods during the asset lifetime . In this case , the economic depreciation series must be computed step by step because it cannot be expressed analytically in a formula like the previous one.

4 SRW stream

4.1 Allocation of the support costs

In the 2012 cost model there are no changes in the way how support costs are allocated :

- All support costs are treated within one SUPPORT module.
- No cascade principle is used meaning that support costs, once in the SUPPORT module, could only be allocated to a non support destination and to a non support division.

A summary of the support activities and their drivers for the 2012 cost model is provided in the following table:

Support activity	Driver FROM support activity
CBU_billing	ALL CBU RETAIL PRODUCTS
CBU_billing_fix products	ALL CBU FIX RETAIL PRODUCTS
CWS_Billing	ALL CWS PRODUCTS
EBU_billing	ALL EBU RETAIL PRODUCTS
EBU_billing_fix products	ALL EBU FIX RETAIL PRODUCTS
Support_Industrial clothing	# FTE SDE_CCGs without an office
MOB_billing	ALL MOBILE LINE RETAIL PRODUCTS
Support_Internal mail services	Avg # FTE ALL LEVELS with office excl. support/centrally booked
Support_IT	ITBuilding
Support_Manage cables	total MOS value
Support_Manage goods, warehouse & equivalents	% Occupation/Picking Lines
Support_Manage internal distribution	Transported Volumes(%Cubages)
Support_Manage moves	Avg # FTE ALL LEVELS with office excl. support/centrally booked
Support_Manage waste and scrap	Avg # FTE ALL LEVELS with office excl. support/centrally booked
Support_Manage, maintain and repair buildings (excluding moves) (office space)	Avg # FTE ALL LEVELS with office excl. support/centrally booked
Support_Manage, maintain and repair buildings (excluding moves) (shop space)	ALL CBU RETAIL PRODUCTS
Support_Manage, maintain and repair fleet vehicles (management vehicles)	#management cars per orgUnit
Support_Manage, maintain and repair fleet vehicles (sales vehicles)	#sales cars per orgUnit
Support_Manage, maintain and repair fleet vehicles (utility vehicles)	#utility cars per orgUnit
SUPPORT_MOB	ALL MOBILE RETAIL PRODUCTS
Support_Power Chain for telecom_SDE	CP_Technical_Building
Support_Provide catering services	Avg # FTE ALL LEVELS with office excl. support/centrally booked
Support_Provide copy services	Avg # FTE ALL LEVELS with office excl. support/centrally booked
Support_Provide printing services (excluding outgoing invoices)	ALL CBU RETAIL PRODUCTS
Support_PROX_Pylons	NE_GroundAntenna
Support_Purchasing, quality and ordering	Amount_of_PO_SDE_nonSDE
Support_Reverse logistics	Nbr_entryLines_RSC
Support_Telecom space_SDE	CP_Technical_Building
Support_13001 Data Managed Services & Applications	
Support_14001 TV and VoD	
Support_15001 CPE GSM	
Support_22243 Nat. IC - infra. Co-location /Co-mingling	
Support_30000 Subsidiaries & externals	
Support_50000 Out of scope	
Support_30000 Subsidiaries & externals	
Support_50000 Out of scope	

4.2 Allocation of Retail costs

4.2.1 Determination of the retail cost perimeter

As stated previously the Belgacom organisational structure distinguishes between 4 distinct organisational pillars called Business units, we recapitulate :

- Consumer Business Unit (CBU) has the responsibility over the residential customers
- Enterprise Business Unit (EBU) has the responsibility over the professional customers
- Service Delivery Engine (SDE) centralises network, Carrier Wholesale and IT services
- Staff and support (S&S) groups all horizontal functions sustaining the Group activities

All commercial retail activities are situated at the level of Business unit CBU (consumer business unit) for the residential customers and at the level of Business unit EBU (enterprise business unit) for the professional customers.

The Belgacom financial and accounting structure clearly registers (directly attributable) retail costs on costcenters 39xxxx (retail for residential customers) or costcenter 41xxxx (retail for professional customers).

However, a number of costs are not directly attributed to retail in the accounting books but do relate to retail activities.

It concerns :

1. Costs which are centrally booked and/or managed but which need to be flagged towards all Belgacom personnel/FTE's (and thus also towards these residing under CBU and EBU). F.e. cost re. Fleet, office building, traincards, bonus, training, gsm's in the context of the employee phone program, ...
2. Non FTE related costs which are centrally booked and managed but relate to retail activities. F.e. Billing, Shop space, ...

The costs under point 1. above are added up with the directly attributable FTE related costs (essentially all payroll costs and all costs categorized with Cost type 'personnel-related', in lesser extent a limited number of costs categorized as 'non personnel-related', i.e. primarily training costs, printing costs and cost for office equipment) and allocated towards the organisational groups (as a general rule, the organisational group corresponds with the cost center group, except for customer care activities (cost center group CCG_CCA) which is restated towards organisational groups corresponding to internal CCA reporting) in module "Organisational_group".

The costs under point 2. above are identified as specific objects in Module Support and are further allocated towards products in the Retail allocation procedure (as described later in this document).

As a result of the above, we can thus identify 4 blocks of retail costs which constitute the perimeter of the retail allocation process :

1. Organisational group costs of organisational groups 39xxx, 41xxx and Customer Care activity (CCA) groups. These are situated at the level of Inca Module "organisational_group".

2. Retail (non FTE related) support costs, identified as specific objects in Inca Module “Support”

Retail related support objects

CBU_billing
 CBU_billing_fix products
 EBU_billing
 EBU_billing_fix products
 MOB_billing
 Support_Manage, maintain and repair buildings (excluding moves) (shop space)
 Support_MOB
 Support_Provide printing services (excluding outgoing invoices)

Table 1 : Retail support objects

3. Retail costs which do not have a direct causal relationship with products. These costs are directed to module “retail”.
4. Retail costs attributable to products, i.e. with an identifiable causal relationship to the products. F.i. Costs of sales and cost of goods sold, Vodafone fee, Bad debt, dedicated outsourcing costs, SOG Marketing costs (campaigns), ...

4.2.2 Retail cost allocation

4.2.2.1 Introduction of 2 cost type attributes

Two cost type attributes are introduced in the cost model.

These attributes are “VAR_TYPE” and “PS_TYPE” and they constitute a unique combination for each CP-CCG.

These attribute-qualifications are defined at the level of the cost base for all CP-CCG combinations except the CP-CCG combinations which are allocated towards CCG_HMC. The attribute-qualifications related to FTE related costs are introduced at the level of the organisational_groups (module ‘organisational_group’).

4.2.2.2 Criteria for Attribute dimension VAR_TYPE

Dimension VAR_TYPE qualifies retail costs based on their variability towards product¹ volumes.

We distinguish between 4 var_types :

¹ Products at the level of the customer (fast internet, TV, voice access, explore, traffic types, ...). These do not correspond with the (aggregated) notion of ABC_products as defined in the INCA cost model.

- a. Marginal (mar) : retail costs which can be considered variable with each additional unit of output of a single product. Typically it concerns costs of goods sold (f.e. handsets, customer premises equipment, ...) and costs of sales (commissions, interconnection costs,...).
- b. Variable (var) : retail costs which can be considered sensitive to (important) volume changes of a single product whereby this product is considered to be the last increment in the product portfolio. Examples of costs which are considered variable based on these criteria : the sales departments (FTE's), call center activities, bad debt, ...
- c. Fix (fix) : retail costs are considered as fixed when they are likely to be inert to important volume variances. F.e. Belgacom's Marketing budget is rather constant over time. Indeed, the allocation towards specific products alters over time, but the absolute amount of this budget is rather linked to the size and market position of the enterprise than to specific products.
- d. Common (common) : retail costs are considered common when they do not relate to the ordinary course of business or have no relation with products. F.e. Costs of litigation, branding & sponsoring expenses, ...

4.2.2.3 Criteria for attribute dimension PS_TYPE

Dimension PS_TYPE qualifies retail costs based on whether they are specifically generated and/or can be attributed directly or through a specific non generic and/or non general driver towards the specific products.

Thus , we distinguish between 2 PS_types :

- a. PRODUCT_SPECIFIC : these costs can either be allocated directly to the products (-and thus are generated specifically for that related product, f.i. the sale of a settopbox-) or they can be allocated to the products through a specific non generic, non general causal driver (f.e. SOG cost of advertising campaigns based on specific expenses on products for advertising campaigns).
- b. NON_PRODUCT_SPECIFIC : Retail costs which do not have a clear (causal) relation with specific products.

4.2.3 Retail allocation process

4.2.3.1 Allocation of organisational group costs (block 1)

Except for Call center activities, for retail, the organisational groups correspond with the cost center groupings as introduced at the level of the cost base.

The criteria as set above (4.2.2.2.) regarding variability are translated towards organisational groups based on this decision table :

	Criteria	Justification
fix FTE	Assigned as Team responsible in FTE file	Assumption of Belgacom as ongoing concern on the long run, independent of product mix or individual product volumes : maintain the same organisational structure (reflected through team respo's)
var FTE	Departments/costs insensitive to product (line) volume changes product (line) volume sensitive	Management & support departments & departments linked to the portfolio of products, not the product volume

Organisational groups dedicated to a specific product are categorized as product_specific.

Organisational groups covering a span of products are categorized as non_product_specific. The introduction of an additional dimension 'cost group' enables us to identify the (span of) products it covers.

Used cost groups at the level of organisational groups are :

CostGroup

11152 BGC Fixed Other traffic
 11302 Directory Assistance Services and listing
 12101 Fast internet
 12311 Data national incl. Explore
 13001 Data Managed Services & Applications
 17020 Mobile traffic, data and Access
 ALL CBU FIX RETAIL PRODUCTS
 ALL CBU RETAIL PRODUCTS
 ALL EBU FIX RETAIL PRODUCTS
 ALL EBU RETAIL PRODUCTS
 ALL FIXED LINE RETAIL PRODUCTS
 ALL MOBILE RETAIL PRODUCTS
 ALL RETAIL PRODUCTS
 MVAS & Mobile traffic, data and access
 Staff teams

Product_specific (dedicated) organizational groups are allocated towards the products (markets) which correspond with the related costgroup (which in casu corresponds with the product).

Non_product_specific fix (parts of) organizational groups are allocated towards Market 'Fixed Common Market 1 – Access PSTN&ISDN & Market 0 – Residual Market'.

Non_product_specific variable (parts of) organizational groups are allocated towards Markets based on volume provisioning drivers (see yellow arrows in organisational group allocation overviews beneath).

Technically the determination of the var_type , the ps_type and the costgroup is done through the allocation of the organisational groups towards module Retail. Module Retail in turn allocates towards products (markets).

4.2.3.1.1 Consumer Business Unit Organisational group allocation

4.2.3.1.1.1 CBU non CCA organizational group allocation

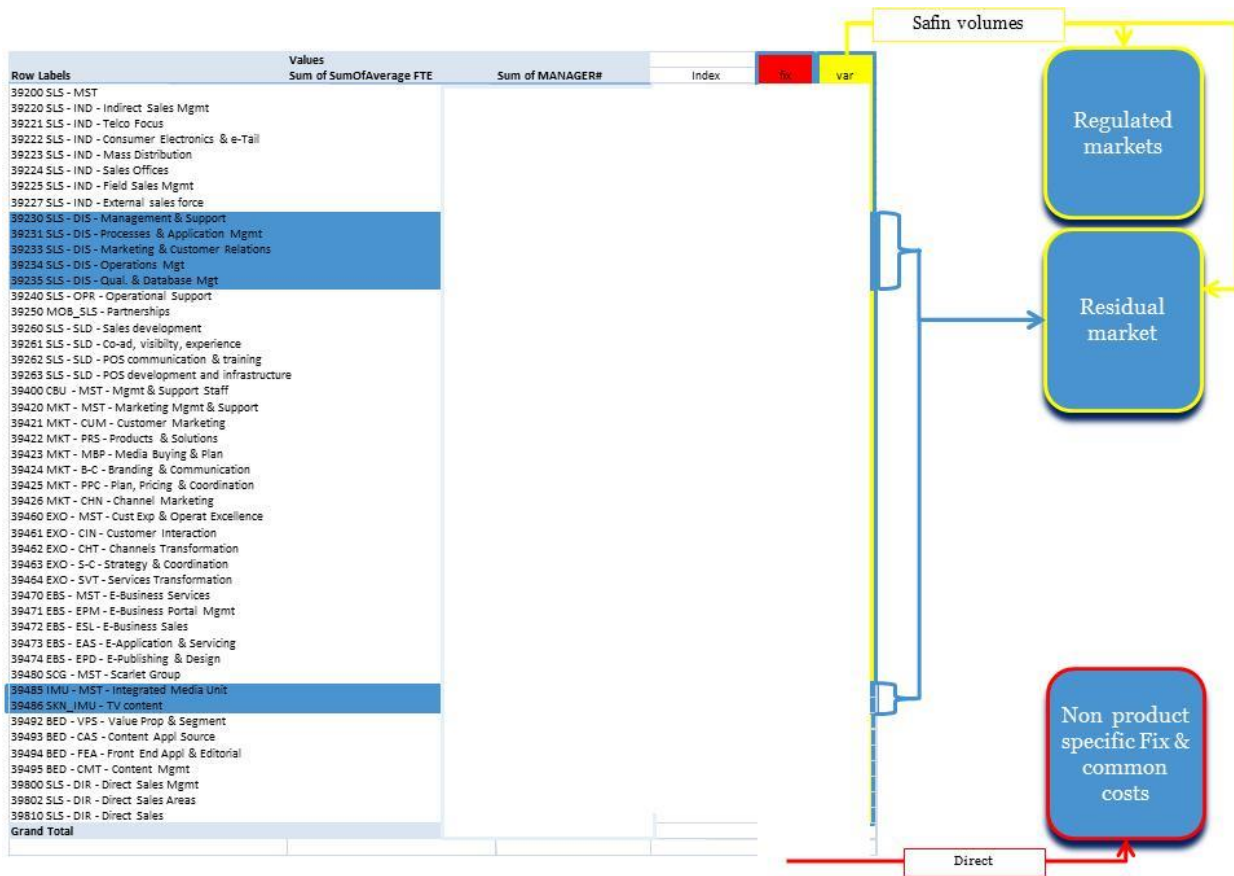

4.2.3.1.1.2 CBU CCA organizational group allocation

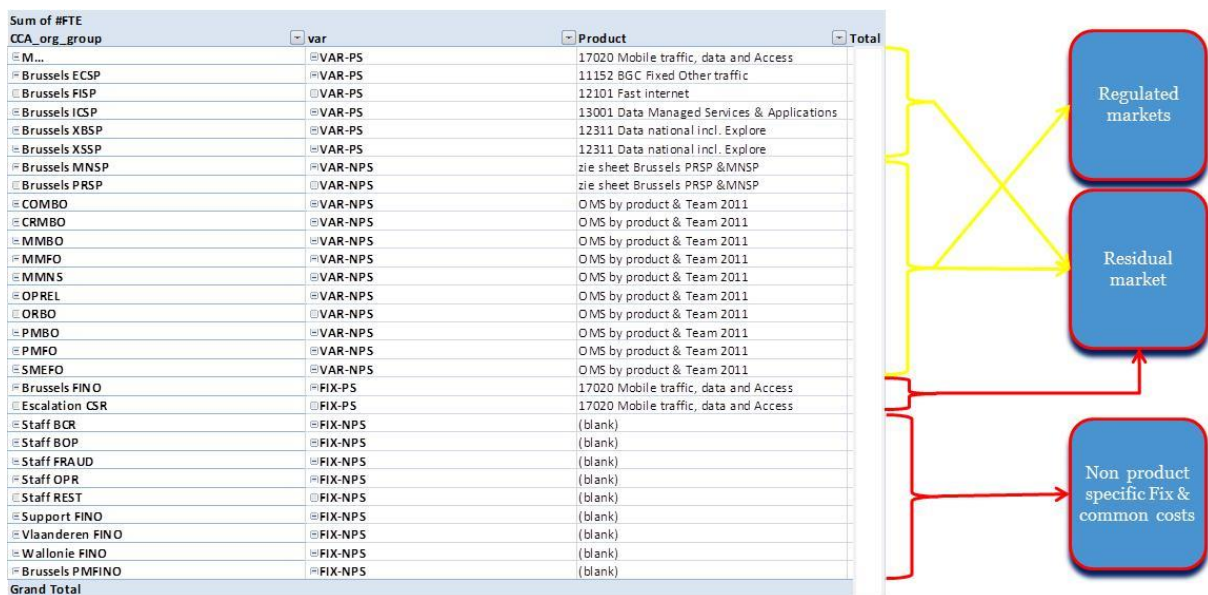

4.2.3.1.2 Enterprise Business Unit Organisational group allocation

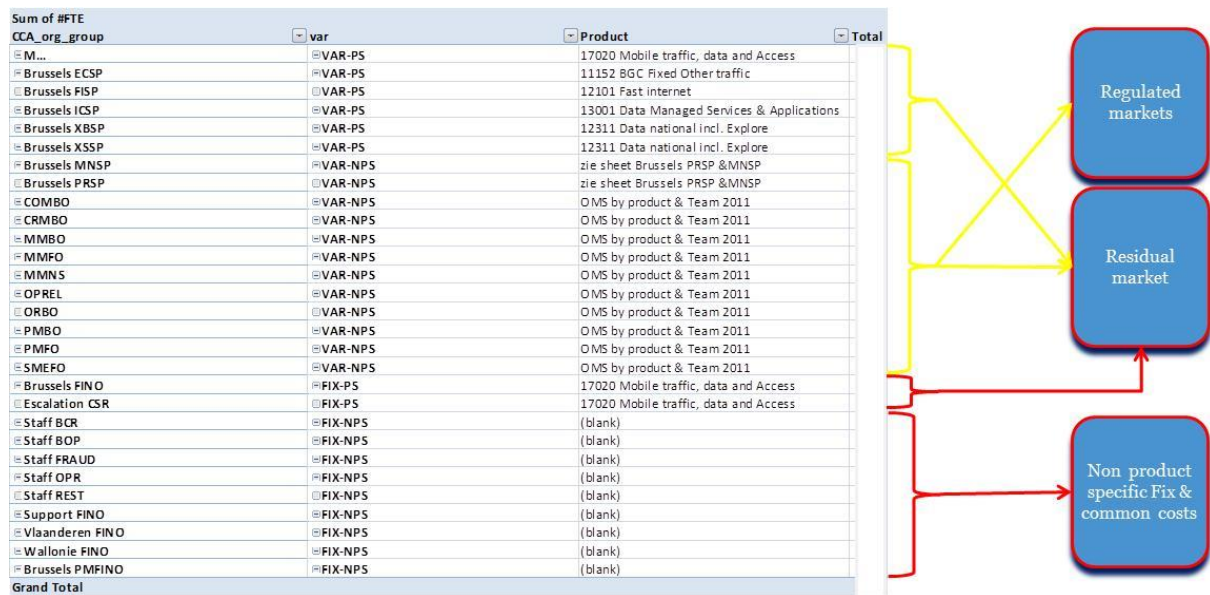

4.2.3.2 Allocation of retail support costs (block 2)

Module ‘Support’ identifies and collects the costs of a number of support objects which a.o. are retail related.

The retail related support objects primarily concern billing costs (invoice printing, stuffing and postage) and costs for shop space.

Costs for shop space are considered fix and non_product_specific as they are not dependant on a specific single product. All residential products are sold in these shops so they are assigned to the cost group “All CBU retail products”.

Billing costs are identified for different costgroups. They are categorized as non_product_specific fix costs. Billing costs are indeed variable towards the customer, but can be considered invariable towards productvolume variances of a specific product, as the vast majority of customers have a portfolio of different products, and thus the absence of 1 specific product out of the customers portfolio will not materially impact the invoicing of that customer.

Retail support costs, as they are materially considered as fix costs, are allocated towards Market ‘Fixed Common Market 1 – Access PSTN&ISDN & Market 0 – Residual Market’.

from destination	dest	COSTGROUP	VAR_TYPE	PS_TYPE
CBU_billing	RETAIL	ALL CBU RETAIL PRODUCTS ALL CBU FIX RETAIL	fix	non_product_specific
CBU_billing_fix products	RETAIL	PRODUCTS	fix	non_product_specific

<u>EBU_billing</u>	RETAIL	ALL EBU RETAIL PRODUCTS	fix	non_product_specific
<u>EBU_billing_fix products</u>	RETAIL	ALL EBU FIX RETAIL PRODUCTS	fix	non_product_specific
<u>MOB_billing</u>	RETAIL	ALL MOBILE RETAIL PRODUCTS	fix	non_product_specific
<u>Support_Manage, maintain and repair buildings (excluding moves) (shop space)</u>	RETAIL	ALL CBU RETAIL PRODUCTS	fix	non_product_specific
<u>Support_MOB</u>	RETAIL	ALL MOBILE RETAIL PRODUCTS	fix	non_product_specific
<u>Support_Provide printing services (excluding outgoing invoices)</u>	RETAIL	ALL CBU RETAIL PRODUCTS	fix	non_product_specific

Table 2 : support retail related objects with attributes

4.2.3.3 Retail costs which do not have a causal relationship with products (block 3)

Retail Costs (not residing under point 4.2.3.1 & 2) not causally related to the products and for which we thus do not have a straightforward driver towards products are grouped in module Retail. Per definition these costs are non_product_specific.

The attributes var_type, ps_type and costgroup (span of products to which the costs relate) are determined based on the analysis of the combination cost pool-cost center group.

Fix and common (based on criteria defined under point 4.2.2.2) non_product_specific costs are allocated towards Market 'Fixed Common Market 1 – Access PSTN&ISDN & Market 0 – Residual Market' or to 'Market 0 - Residual Market' in case of costgroup 'Residual market'.

Variable non_product_specific costs are allocated based on a number of drivers as displayed in table beneath depending on the combination var_type, organisational group and cost group.

VAR_TYPE	var	
PS_TYPE	non_product_specific	
from descr cost group		Driver
ALL CBU RETAIL PRODUCTS	39220 SLS - IND - Indirect Sales Mgmt_var_non_product_specific	SAFIN volumes IND
	39227 SLS - IND - External sales Force_var_non_product_specific	SAFIN volumes IND
	39240 SLS - CHN - Sales Operational Support_var_non_product_specific	SAFIN Volumes IND/DIR
	39470 SLS - EBS - E-Business Services_var_non_product_specific	SAFIN volumes ECH
	39471 SLS - EBS - EPM - E-Business Portal Mgmt_var_non_product_specific	SAFIN volumes ECH
	39472 SLS - EBS - ESL - E-Business Sales_var_non_product_specific	SAFIN volumes ECH
	39473 SLS - EBS - EAS - E-Application & Servicing_var_non_product_specific	SAFIN volumes ECH
	39474 SLS - EBS - EPD - E-Publishing & Design_var_non_product_specific	SAFIN volumes ECH
	39800 SLS - DIR - Direct Sales Mgmt_var_non_product_specific	SAFIN volumes DIR
	39810 SLS - DIR - Direct Sales_var_non_product_specific	SAFIN volumes DIR
	CCG_CCA_var_non_product_specific	SAFIN volumes CCA
ALL EBU RETAIL PRODUCTS	41000 EBU - MST - Mgmt & Support Staff_var_non_product_specific	EBU revenue
	41002 EBU - MST - Dummy_var_non_product_specific	EBU revenue
	41200 INT - EBU International_var_non_product_specific	EBU revenue
	41300 COR - MST - Mgmt & Support Staff_var_non_product_specific	EBU revenue
	41311 COR - SFM - Sales Finance, Ind & Media_var_non_product_specific	EBU provisioning volumes
	41312 COR - SPH - Sales Public & Health_var_non_product_specific	EBU provisioning volumes
	41320 COR - SPS - Specialised Sales_var_non_product_specific	EBU provisioning volumes
	41340 COR - OUT - Outsourcing_var_non_product_specific	EBU revenue
	41350 COR - BID - Marketing_var_non_product_specific	EBU revenue
	41360 COR - BID - Bid Sales Ops & Marketing_var_non_product_specific	EBU revenue
	41370 COR - PS - Pre Sales_var_non_product_specific	EBU provisioning volumes
	41380 COR - STS - Solutions Sales_var_non_product_specific	EBU provisioning volumes
	41510 SME - SAL - Sales Area_var_non_product_specific	EBU provisioning volumes
	41530 SME - SSP - Specialised Sales & Presales_var_non_product_specific	EBU provisioning volumes
	41540 SME - CSI - Channel Strategy & Integration_var_non_product_specific	EBU revenue
	41550 SME - MKT - Marketing_var_non_product_specific	EBU revenue
	41560 SME - SEI - Sales & Indirect_var_non_product_specific	EBU provisioning volumes
	41600 PRS - MST - Product & Solutions Mgmt_var_non_product_specific	EBU revenue
	41610 PRS - PPR - Cross-Product Partnership & Pricing_var_non_product_specific	EBU revenue
	41620 PRS - CIF - Mobility_var_non_product_specific	EBU revenue
	41640 PRS - OUC - Unified Collaboration_var_non_product_specific	EBU revenue
	41650 PRS - HUS - Wan, Internet & Security Services_var_non_product_specific	EBU revenue
	41680 PRS - MMP - M2M Integrated Solutions_var_non_product_specific	EBU revenue
	41740 OPE - CPM - Customer Project Mgmt_var_non_product_specific	EBU revenue
	41750 OPE - BSC - Business Support Center_var_non_product_specific	EBU provisioning volumes
	41810 BDV - BCD - Be Cloud_var_non_product_specific	EBU revenue
	41820 BDV - BDV - Busin. Developm. Verticals_var_non_product_specific	EBU revenue
	41830 BDV - BPP - Business Planning & Partnership_var_non_product_specific	EBU revenue
	CCG_CCA_var_non_product_specific	EBU revenue

Table 3 : Retail drivers (non organisational group) non product specific variable costs

4.2.3.4 Retail costs with causal relation to products (block 4)

The main costs of this category are bad debt (and bad debt related costs), Costs of sales, Marketing expenses and consultancy costs.

All combinations of VAR_type and PS_type may occur.

F.i. bad debt (& related costs) is not really a characteristic of a specific product as such, in fact it is the customer who becomes insolvent. So in that view we consider 'bad debt' as a non product specific cost. It is however a variable cost as the risk and materiality of insolvency increases with growing product volumes and thus growing revenue. Moreover, based on the unpaid invoice amounts per product we have a clear identifiable causal driver towards the products.

Bad debt is consequently considered as a variable non product specific cost with a causal driver towards the products.

The drivers for (Non organisational group) retail costs with a causal relation are listed below :

Attribute	Driver
☐BAD DEBT	☑SAP documenttype split mob-fix & unpaid invoices (for fix) for GL63 (amount in €) ☑SAP documenttype split mob-fix & unpaid invoices (for fix) for GL64 (amount in €) ☑SAP documenttype split mob-fix (amount in €) ☑SAP Documenttype split mob-fix (amount in €) & CCG ☑SAP documenttype split mob-fix (amount in €) & CP
☐COGS	☑Direct direct margin cube SAP product ☑Direct margin cube SAP product (amount in €) ☑Direct_ccg ☑Direct_cp ☑Direct_cp_ccg ☑SAP invoices analysis (amount n €) ☑SAP product - Amount in €
☐MAT	☑Direct fair allocation following CCG stock consumption cp 6035 ☑Direct fair allocation following CCG stock consumption cp 6060 ☑Direct_cp ☑Direct_cp_ccg
☐OTHER OPEX	☑Detail MKT AL Mardaga taxes (amount in €) ☑Direct detail SAP ☑Direct_ccg ☑Direct_cp ☑Direct_cp_gl ☑Direct_cp_gl_ccg
☐SOG	☑Bad debt Prorata (split fix - mob) & unpaid invoices (for fix) for GL61 (amount in €) ☑BCR info + CCA opex split for fixed line ☑Detail Campaign management (amount in€) ☑Detail MKT AL Mardaga GL614 (amount in €) ☑Detail MKT AL Mardaga postage (amount in €) ☑Detail numbering (amount in €) ☑Detail outsourcing (amount in €) ☑Direct ☑Direct BCR info ☑Direct detail numbering ☑Direct detail SAP ☑Direct_ccg ☑Direct_costtype ☑Direct_cp ☑Direct_cp_ccg ☑Direct_cp_non material ☑Indirect channel Advertising detail (amount in €) ☑Split Direct marketing/Mailing based on General ledger account + Detail MKT AL Mardaga postage & GL61 ☑Split Mob/fix based on supplier (amount in €) + split fix part based on OMS orders (#of orders) ☑Vodafone Fee_2011 detail (amount in €)

4.2.3.5 Graphical view on retail allocation flow

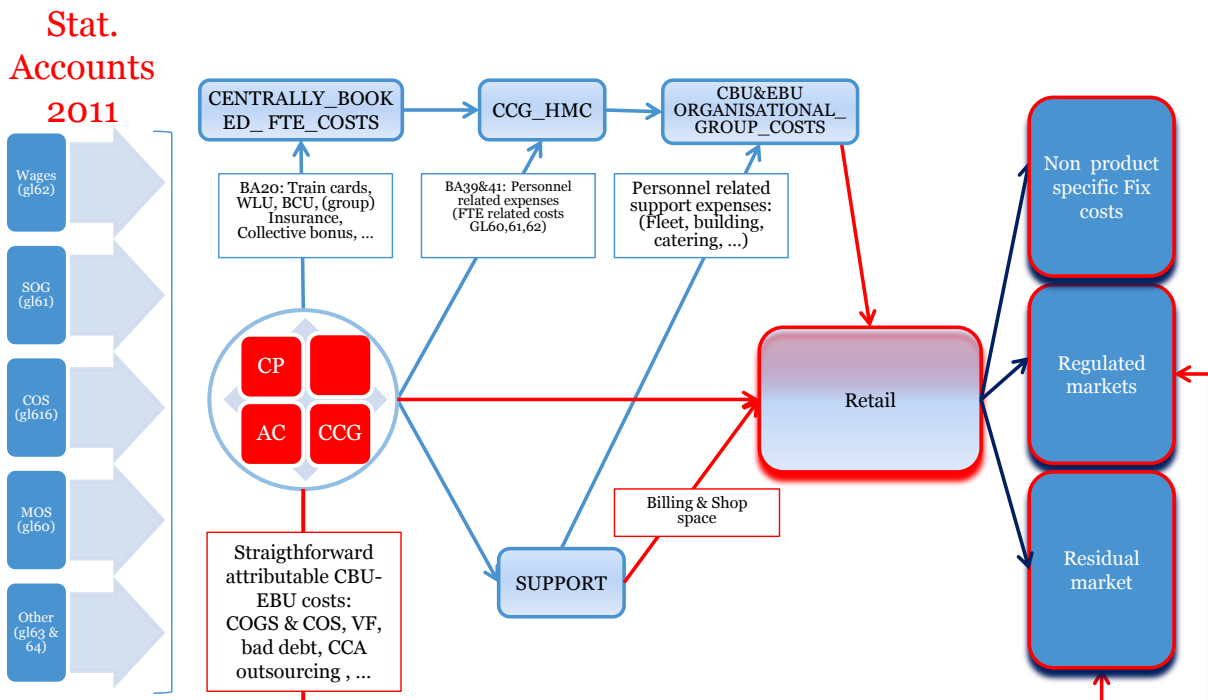

CP = costpool = a grouping of G/L accounts/costs which have similar characteristics and reside under the same nature of costs. Typically, the G/L accounts/costs consolidated in a single cost pool feature the same causal relation to the end products.
 •CCG = cost center grouping = grouping of cost centers with comparable characteristics
 •AC = Asset Class

Figure 11: Retail Allocation Flow - General

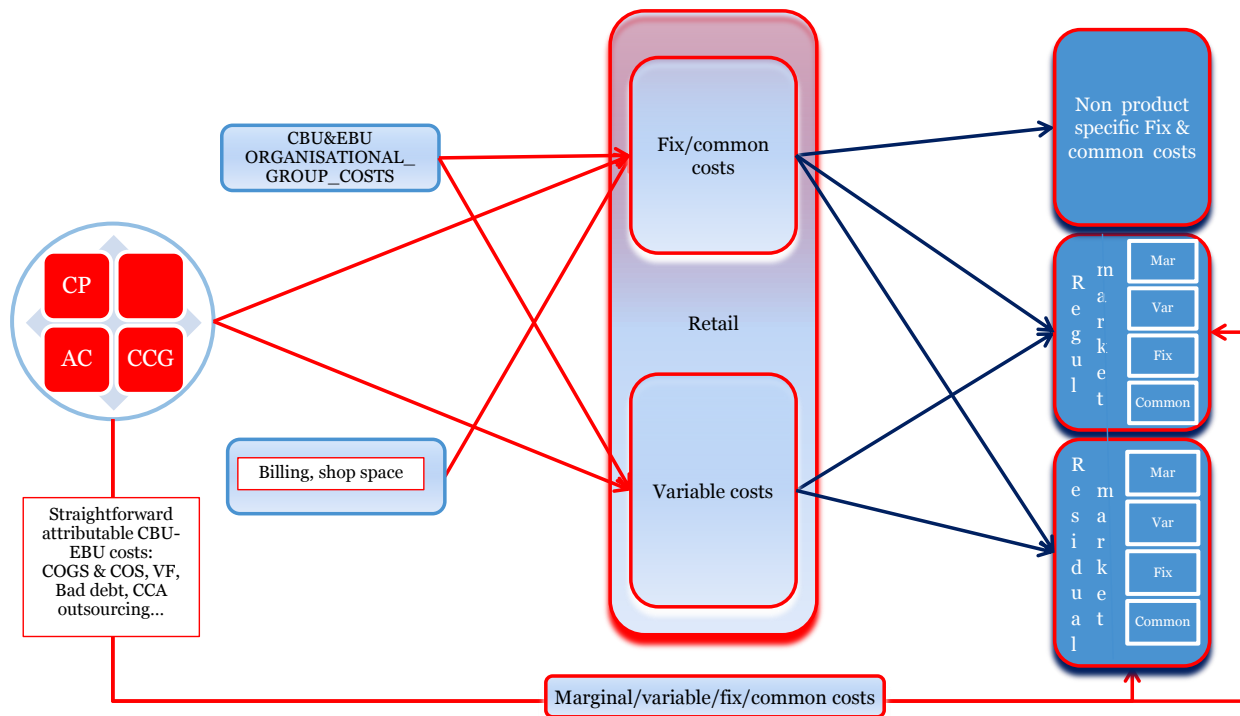

Figure 12: Retail Allocation Flow - Fix / Var

4.3 Allocation of CWS (Customer Whole Sale Division) related costs

The allocation flow and principles are identical to the retail cost allocation flow.

4.3.1 Determination of the CWS cost perimeter

All Wholesale activities are situated at the level of Business unit CWS (Customer Whole Sale).

The Belgacom financial and accounting structure clearly registers (directly attributable) Wholesale costs on costcenters 40xxxx.

However, a number of costs are not directly attributed to wholesale in the accounting books but nevertheless do relate to Wholesale activities.

It concerns :

1. Costs which are centrally booked and/or managed but which need to be flagged towards all Belgacom personnel/FTE's (and thus also towards these residing under CWS). F.e. cost re. Fleet, office building, traincards, bonus, training, gsm's in the context of the employee phone program, ...
2. Non FTE related costs which are centrally booked and managed but relate to Wholesale activities F.e. Billing.

The costs under point 1. above are added up with the directly attributable FTE related costs (essentially all payroll costs and all costs categorized with Cost type 'personnel-related', in lesser

extent a limited number of costs categorized as ‘non personnel-related’, i.e. primarily training costs, printing costs and cost for office equipment) and allocated towards the organisational groups (as a general rule, the organisational group corresponds with the cost center group) in module “Organisational_group”.

The costs under point 2. above are identified as specific objects in Module Support and are further allocated towards products in the Wholesale allocation procedure (as described later in this document).

As a result of the above, we can thus identify 4 blocks of Wholesale costs which constitute the perimeter of the Wholesale allocation process :

1. Organisational group costs of organisational groups 40xxx. These are situated at the level of Inca Module “organisational_group”.
2. (Non FTE related) support costs, specifically it concerns the support object “CWS billing” (i.e. costs for invoice printing, stuffing and postage) in Inca Module “Support”.
3. Wholesale costs which do not have a direct causal relationship with products. These costs are directed to module “Wholesale”.
4. Wholesale costs attributable to products, i.e. with an identifiable causal relationship to the products. F.i. Costs of sales and cost of goods sold, Vodafone fee, Bad debt, ...

4.3.2 WholeSale cost allocation

4.3.2.1 Introduction of 2 cost type attributes

Two cost type attributes are introduced in the cost model.

These attributes are “VAR_TYPE” and “PS_TYPE” and they constitute a unique combination for each CP-CCG.

These attribute-qualifications are defined at the level of the cost base for all CP-CCG combinations except the CP-CCG combinations which are allocated towards CCG_HMC.

The attribute-qualifications related to FTE related costs are introduced at the level of the organisational_groups (module ‘organisational_group’).

4.3.2.2 Criteria for Attribute dimension VAR_TYPE

Dimension VAR_TYPE qualifies wholesale costs based on their variability towards product² volumes.

We distinguish between 4 var_types :

- a. Marginal (mar) : wholesale costs which can be considered variable with each additional unit of output of a single product. Typically it concerns costs of goods sold (f.e. handsets, customer premises equipment, ...) and costs of sales (commissions, interconnection costs,...).

² Products at the level of the customer (fast internet, TV, voice access, traffic, ...). These do not correspond with the (aggregated) notion of ABC_product as defined in the INCA cost model.

- b. Variable (var) : wholesale costs which can be considered sensitive to (important) volume changes of a single product whereby this product is considered to be the last increment in the product portfolio. Examples of costs which are considered variable based on these criteria : the sales departments (FTE's), call center activities, bad debt, ...
- c. Fix (fix) : wholesale costs are considered as fixed when they are likely to be inert to important volume variances.
- d. Common (common) : wholesale costs are considered common when they do not relate to the ordinary course of business or have no relation with products. F.e. Costs of litigation, branding & sponsoring expenses, ...

4.3.2.3 Criteria for attribute dimension PS_TYPE

Dimension PS_TYPE qualifies wholesale costs based on whether they are specifically generated and/or can be attributed directly or through a specific non generic and/or non general driver towards the specific products.

Thus , we distinguish between 2 PS_types :

- a. PRODUCT_SPECIFIC : these costs can either be allocated directly to the products (-and thus are generated specifically for that related product, f.i. the sale of a settopbox-) or they can be allocated to the products through a specific non generic, non general causal driver (f.e. SOG cost of advertising campaigns based on specific expenses on products for advertising campaigns).
- b. NON_PRODUCT_SPECIFIC : Wholesale costs which do not have a clear (causal) relation with specific products.

4.3.3 Wholesale allocation process

4.3.3.1 Allocation of organisational group costs (block 1)

For Wholesale, the organisational groups correspond with the cost center groupings as introduced at the level of the cost base.

The criteria as set above (4.3.2.2.) regarding variability are translated towards organisational groups based on this decision table :

Criteria	Justification
fix FTE Assigned as Team responsible in FTE file Departments/costs insensitive to product (line) volume changes	Assumption of Belgacom as ongoing concern on the long run, independent of product mix or individual product volumes : maintain the same organisational structure (reflected through team respo's) Management & support departments & departments linked to the portfolio of products, not the product volume
var FTE product (line) volume sensitive	

Organisational groups dedicated to a specific product are categorized as product_specific.

Organisational groups covering a span of products are categorized as non_product_specific. The introduction of an additional dimension 'cost group' enables us to identify the (span of) products it covers.

Used cost groups at the level of organisational groups are :

COSTGROUP
20000 Mobile Roaming IN
ALL CWS COMMERCIAL PRODUCTS
ALL CWS products
ALL CWS products exc. Roaming

4.3.3.1.1 Customer WholeSale Unit Organisational group allocation

CCG 2011	TeamName2	TeamName	Values			Variability decision			Product driver	
			Average	Sum of	PTE MANAGER	index	fix	var		Costgroup
40000 CWS - MST - Mgmt & Support Staff	Carrier & Wholesale	CARRIER & WHOLESAL							All CWS products	na
40200 CWS - SAL - Sales	S&D CHANNEL & KEY PARTNERS	S&D CHANNEL & KEY PARTNERS							All CWS products	provisioning volume
	S&D CHANNEL & KEY PARTNERS	S&D CHANNEL & KEY PARTNERS							All CWS products	provisioning volume
	S&D MANAGEMENT & SALES OPERATIONS	S&D MANAGEMENT & SALES OPERATIONS							All CWS products	provisioning volume
	SALES	SALES							All CWS products	provisioning volume
40800 CWS - Ops - Carrier Prod & Solutions	BRANDS AND ACCESS	BRANDS AND ACCESS							All CWS products exc roaming	na
	MARKETING	MARKETING							All CWS products exc roaming	na
	PRODUCT & MARKET MANAGEMENT	PRODUCT & MARKET MANAGEMENT							All CWS products exc roaming	na
	PROFESSIONAL CONNECTIVITY	PROFESSIONAL CONNECTIVITY							All CWS products exc roaming	na
	STRATEGY & ENVELOPE	STRATEGY & ENVELOPE							All CWS products exc roaming	na
	VOICE & WHOLESAL PLATFORMS	VOICE & WHOLESAL PLATFORMS							All CWS products exc roaming	na
40400 CWS - OCA - Customer Care	CUSTOMER CARE	CUSTOMER CARE							All CWS products	na
	Operational excellence	BUSINESS QUALITY							All CWS products	na
		BUSINESS PROCESSES							All CWS products	na
		BUSINESS SYSTEMS							All CWS products	na
		BUSINESS TESTING							All CWS products	na
	Customer center payments	CUSTOMER IMPAIRMENT							All CWS products	na
		COLLECTIONS							All CWS products	product revenue weight
		DISPUTES							All CWS products	product revenue weight
		PRODUCTION BILLING							All CWS products	product revenue weight
		VALUATIONS							All CWS products	product revenue weight
		PRODUCTION BILLING HANDBOOK							All CWS products	product revenue weight
	CUSTOMER HELPDESK	CUSTOMER HELPDESK							All CWS products	Database driver SC calls time in minutes (weighted for 40%) & cases created (P)
	CUSTOMER SUPPORT DESK	CUSTOMER SUPPORT DESK							All CWS products	Database driver SC cases created (weighted for 40%)
	Exception handling	EXCEPTION HANDLING DESK							All CWS products	Database driver SC cases closed
		MONITORING							All CWS products	Database driver SC cases closed
		PRODUCT PROVISIONING							All CWS products	Database driver SC cases closed
		RESOLV							All CWS products	Database driver SC cases closed
40600 CWS - SOI - Solution Design & Implementation	SERVICE DELIVERY & PROJECT MANAGEMENT	SERVICE DELIVERY & PROJECT MANAGEMENT							All CWS products exc roaming	Subscribers
	SOLUTION DESIGN & IMPLEMENTATION	SOLUTION DESIGN & IMPLEMENTATION							All CWS products exc roaming	Subscribers
	TECHNICAL PRE-SALES	TECHNICAL PRE-SALES							All CWS products exc roaming	provisioning volume
40600 MOB_CWS - MOA - Roaming	ROAMING	ROAMING							roaming	na
40700 CWS - BPM - Business Performance Mgmt	BUSINESS PERFORMANCE	BUSINESS PERFORMANCE							All CWS products	na
Grand Total										

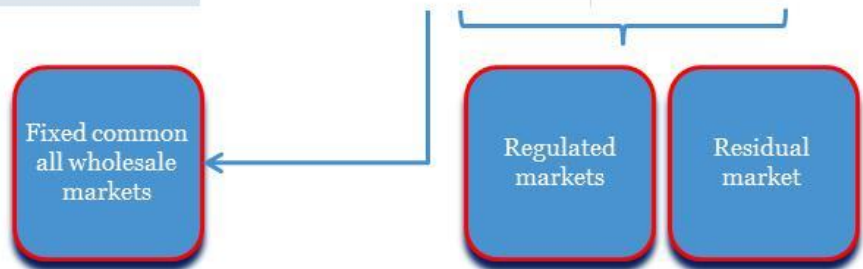

4.3.3.2 Allocation of WholeSale support costs (block 2)

The Wholesale support costs as identified in Module “support” specifically concern “CWS_Billing” (i.e. costs for invoice printing, stuffing and postage).

We qualify CWS_Billing as a fix non_product_specific cost.

For sure, billing costs are customer specific, but in the light of the major and majority of the clients having more than 1 product, we can state that these costs are non product specific.

Indeed, analyses at the level of the customer clusters learns that 54% of the customer clusters, adding up to more than 99% of the (non traffic) revenue, are CWS client for at least 2 products. In this context it is fair to state that the billing cost will not materially alter in absence of one specific product, and thus that billing costs are not variable towards a specific product.

Wholesale support costs, i.e CWS_Billing, are allocated towards “Fixed Common Wholesale Markets”.

4.3.3.1 Wholesale costs which do not have a causal relationship with products (block 3)

Wholesale Costs (not residing under point 4.3.3.1 & 2) not causally related to the products and for which we thus do not have a straightforward driver towards products are grouped in module Wholesale. Per definition these costs are non_product_specific.

The attributes var_type, ps_type and costgroup (span of products to which the costs relate) are determined based on the analysis of the combination cost pool-cost center group.

Fix and common (based on criteria defined under point 4.3.2.2) non_product_specific costs are allocated towards ‘Fixed Common Wholesale Markets’.

Variable non_product_specific costs are allocated based on a number of drivers as displayed in table beneath depending on the combination var_type, organisational group and cost group.

from descr cost group	Driver
☒ ALL CWS COMMERCIAL PRODUCTS	product Revenue weight
☒ ALL CWS PRODUCTS	product Revenue weight
☒ ALL CWS PRODUCTS EXC. ROAMING	subscriptions
ALL CWS PRODUCTS excl. 20000 Mobile Roaming IN, 21160 Mobile Terminating (voice), 27001 Oher wholesale Mobile & 23001 Data	
☒ Managed Services & Applications	product Revenue weight

4.3.3.2 Wholesale costs with causal relation to products (block 4)

The main costs are bad debt and related costs, Costs of sales and consultancy costs.

The drivers for (Non organisational group) wholesale costs with a causal relation are listed below :

Sum of Amount Attribute	Driver
BAD DEBT	SAP documenttype split mob-fix (amount in €)
	SAP Documenttype split mob-fix (amount in €) & CCG
	SAP documenttype split mob-fix (amount in €) & CP
COGS	CWS Direct margin Cube (amount in €)
	Direct
	Direct_cp
	Direct_cp_ccg
MAT	Direct_cp
OTHER OPEX	Detail Accounting CWS (amount in €)
	Direct detail SAP - Doscom 23610
SOG	Detail SAP (amount in €)
	Direct detail numbering
	Direct detail SAP
	Direct_ccg
	Info CWS (amount in €)
	VodafoneFee_2011 detail (amount in €)

4.3.3.3 Graphical view on Wholesale allocation flow

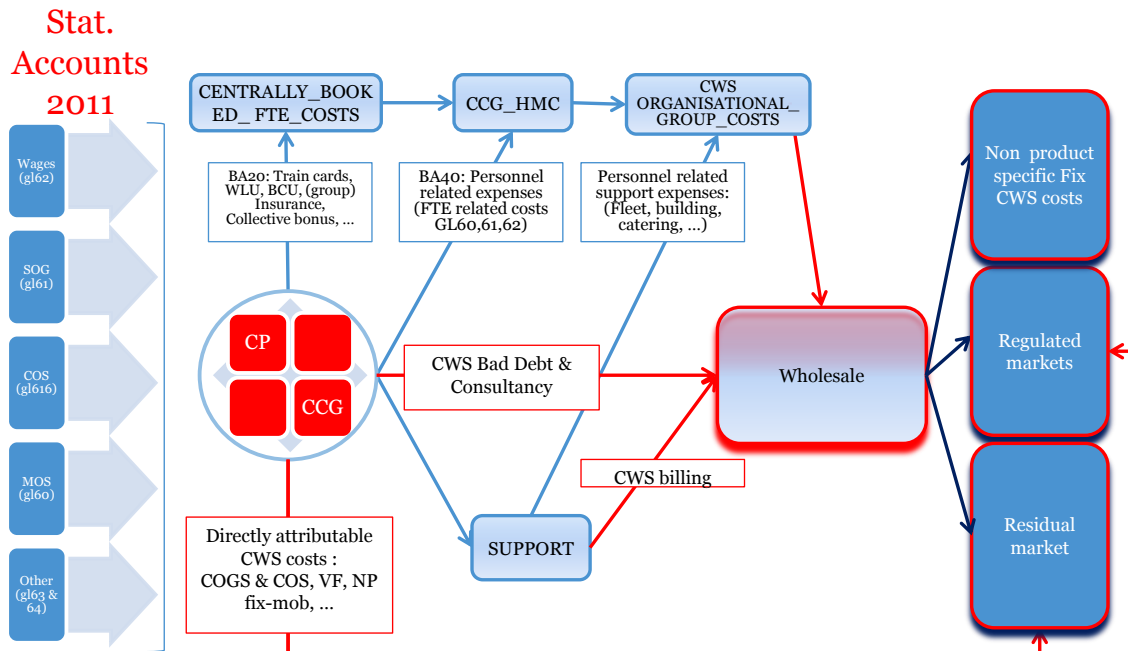

CP = costpool = a grouping of G/L accounts/costs which have similar characteristics and reside under the same nature of costs. Typically, the G/L accounts/costs consolidated in a single cost pool feature the same causal relation to the end products.
 •CCG = cost center grouping = grouping of cost centers with comparable characteristics

Figure 13: Wholesale Allocation Flow - General

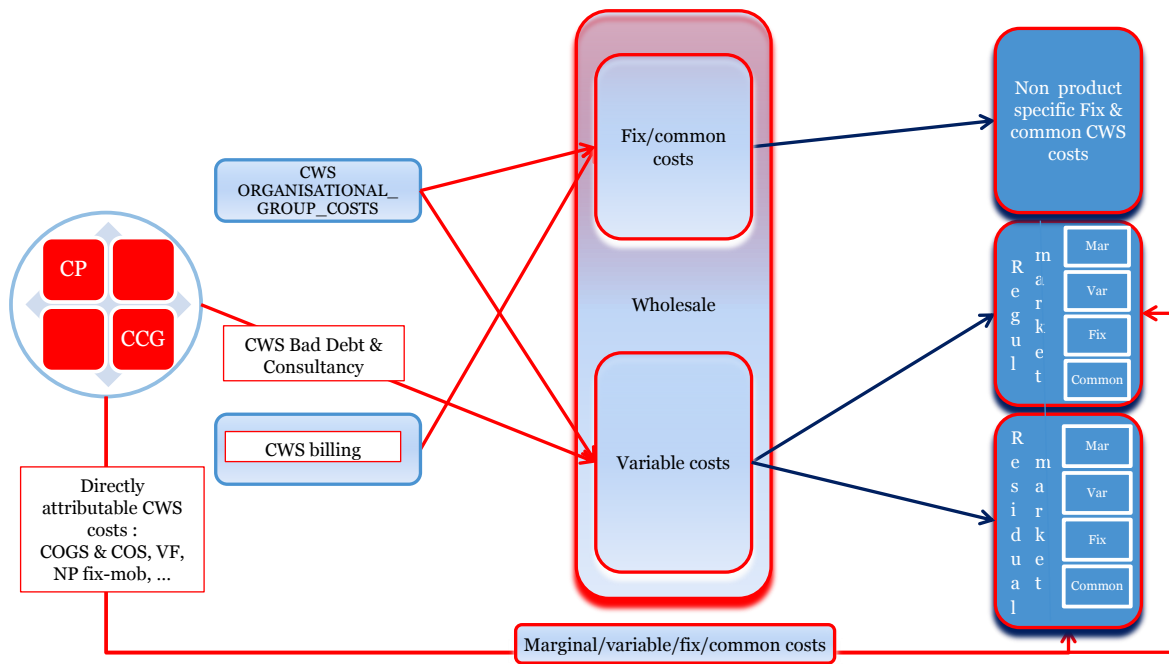

Figure 14: Wholesale Allocation Flow - Fix / Var

5 SDE OPEX (network&IT) stream

5.1 Allocation of SDE OPEX costs going through the “SDE” INCA module

5.1.1 Determination of the SDE cost perimeter

As stated previously the Belgacom organisational structure distinguishes between 4 distinct organisational pillars called Business units, we recapitulate :

- Consumer Business Unit (CBU) has the responsibility over the residential customers
- Enterprise Business Unit (EBU) has the responsibility over the professional customers
- Service Delivery Engine (SDE) centralises network, Carrier Wholesale and IT services
- Staff and support (S&S) groups all horizontal functions sustaining the Group activities

All commercial retail activities are situated at the level of Business unit CBU (consumer business unit) for the residential customers and at the level of Business unit EBU (enterprise business unit) for the professional customers.

All network & IT activities are situated at the level of Business unit SDE (Service Delivery Engine), as well as the wholesale activities (CWS).

The Belgacom financial and accounting structure clearly registers (directly attributable) SDE costs on cost centers 50xxxx, separately from the wholesale costs booked on cost centers 40xxxx.

However, a number of costs are not directly attributed to SDE in the accounting books but do relate to SDE activities.

It concerns :

1. Costs which are centrally booked and/or managed but which need to be flagged towards all Belgacom personnel/FTE's (and thus also towards these residing under SDE).
E.g. cost re. Fleet, office building, train cards, bonus, training, gsm's in the context of the employee phone program.
2. Non FTE related costs which are centrally booked and managed but relate to SDE activities
E.g. Telco space & power.

The costs under point 1. above are added up with the directly attributable FTE related costs (essentially all payroll costs and costs categorized with Cost type 'personnel-related', in lesser extent a limited number of costs categorized as 'non personnel-related', i.e. primarily training costs, printing costs and cost for office equipment) and allocated towards the organisational groups (as a general rule, the organisational group corresponds with the cost center group, except for hybrid network & IT CCG's, like CIS ISD NSC, or COP field CCG's, like COP CFO Cable & Mass/Professional) in module “Organisational_group”.

The costs under point 2. (telco & power space) above are identified as specific objects in Module Support and are further allocated towards network or IT elements but not to the SDE module. So their allocation will not be described in this subchapter.

The “SDE” INCA module costs are primarily sourced from the following INCA modules :

1. Organisational_Group
This concerns the costs of organisational groups 50xxx.
2. CP1
This concerns the outsourcing costs of the field and the remote activities of COP/Customer Operations (COP CRO & COP CFO Cable & Mass/Professional).
3. BA50 Wages
This concerns the PFA (Produced Fixed Assets, the capitalized manpower).
4. BA50_SOG
This primarily concerns costs for consultancy bodyshopping in order to face the lack of manpower during peak times.

5.1.2 SDE cost allocation

5.1.2.1 Introduction of 2 cost type attributes

Two cost type attributes are introduced in the cost model.

These attributes are “VAR_TYPE” and “PS_TYPE”.

For SDE, unlike for retail, these attribute-qualifications are not defined at the level of the cost base for all CP-CCG combinations but only for the FTE related costs at the level of the organisational_groups (module “organisational_group”).

5.1.2.2 Criteria for Attribute dimension VAR_TYPE

Dimension VAR_TYPE only qualifies SDE FTE-related costs in the SDE module, unlike in the retail module.

Variability refers to the service volume produced by the company in the long-run. This variability has 2 dimensions : volume within a product or diversity of products. The considered increment is the whole product. E.g. PSTN : what if we stop PSTN, which costs do we avoid? This is very hard to reach, especially in a top-down model.

Therefore, we prefer to opt for a simple approach that is only an approximation of the minimum fixed costs, by only considering as fixed FTE-related costs the minimum organizational structure, represented in the 2012 year model by the persons attributed with a “team responsibility” or in an MST cost center, as officially reported in the SAP accounting system.

We distinguish between 2 var_types only (unlike Retail, with 4 var types):

1. Fix (fix) : SDE FTE-related costs are considered as fixed when they are related to the minimum organizational structure (represented by the team managers in the 2012 model and the Management & support teams) should there be a change in the long run.
2. Variable (var) : SDE costs which are not considered as fixed according to the definition hereabove (hence overestimated).

5.1.2.3 Criteria for attribute dimension PS_TYPE

Dimension PS_TYPE qualifies SDE costs based on whether they are specifically generated and/or can be attributed directly or through a specific non generic and/or non general driver towards the specific products.

We only have one category in the SDE module :

- a. NON_PRODUCT_SPECIFIC : SDE costs which do not have a clear (causal) relation with specific products.

5.1.3 SDE allocation process

5.1.3.1 Allocation of “Organisational_Group” costs

Except for COP field as well as hybrid (network & IT) teams, for SDE, the organisational groups correspond with the cost center groupings as introduced at the level of the cost base.

The criteria as set above (5.1.2.2.) regarding variability are currently translated towards organisational groups based on this decision table :

Criteria	Justification
fix FTE Assigned as Team responsible in SAP	Assumption of Belgacom as ongoing concern on the long run, independent of product mix or individual product volumes : maintain the same organisational structure (reflected through team respo's)
Assigned to an MSTcost center in SAP	MST cost centers are referring to Management & Support teams

Organisational groups dedicated to a specific product are categorized as product_specific.

Organisational groups covering a span of products are categorized as non_product_specific.

In SDE, all organisational groups have been defined as “non_product_specific”.

The allocation for fix & var (parts of) SDE organizational groups is the same.

The FTE related costs of organizational groups are allocated towards network or IT elements based on time or efforts spent for these respective network or IT elements, as registered in various reporting systems depending upon the department (CANVAS/PLATO working hours for NEO, TM1 Dispatch Units for COP CFO, CMS working minutes for COP CRO, Rapid for CIS & ITS).

5.1.3.1.1 Service Delivery Engine Organisational group allocation

5.1.3.1.1.1 SDE network & IT OPEX organizational group allocation

Model	SDE	without CWS				
Sum of DEC 2012	Column Labels			Variability decision		
Row Labels	FALSE	TRUE	Total	index	fix	var
50454 COP - CFO - Cable						
50455 COP - CFO - Mass and Prof Market						
50450 COP - CFO - Areas and Earth Stations						
50926 NEO - OPP - Area 1-5						
50300 COP - CRO - Customer Help Center						
50923 NEO - IPP - Plant N-B-S						
50297 CIS - ISD - ICT Service Desk						
50912 NEO - FAN - PM - Program Mgmt - Area 1-5						
50285 CIS - SCC - CNN - Connectivity						
50287 CIS - NUC - Network Integration & Unified Communications						
50400 COP - OPE - Operational Excellence						
50286 CIS - SIN - System Integration						
50298 CIS - ISD - NSC - Network & Services Monitoring Centre						
50924 NEO - IPP - VHR - Very High Rate & Radio						
50296 CIS - SID - Service Integration & Delivery Mgmt						
50661 ITS - CSS - EUS - End User Support Services						
50918 NEO - BNC - Backbone & Network Consolidation						
50284 CIS - SCC - MVC - Mobile Voice Core & FESO						
50930 NEO - RPP - DTO - Data & Transport Operations						
50655 ITS - BSS - PCA - Architecture, Customer & Product Mgmt						
50672 ITS - ISS - SOP - Special Operations						
50289 CIS - PSP - TVE - TV Entertainment						
50294 CIS - PSP - CSD - Customer Solution design						
50654 ITS - BSS - OMG - Order Management						
50663 ITS - CSS - TTR - Test, Training & Release						
50292 CIS - PSP - IIS - IMS & IN Services						
50653 ITS - BSS - BIL - Billing						
50282 CIS - SCC - FVC - Fixed Voice Core						
50678 ITS - OSS - ARE - Assurance & Recovery						
50670 ITS - ISS - DTA - Data						
50675 ITS - OSS - CRA - CRM & Assurance						
50804 APP - MST - IAP - IT Architecture, Progr. & Process Mgmt						
50673 ITS - ISS - SVR - Servers						
50283 CIS - SCC - DAC - Data Core						
50802 APP - MST - PRM - Project, Vendor & Resource Mgmt						
50659 ITS - CSS - OFA - Office Automation						
50677 ITS - OSS - SEM - Service Mgmt						

50903 NEO - OPE - Operational Excellence						
50665 ITS - ESS - EBI - Enterprise Business Intelligence						
50291 CIS - PSP - NCS - Network & Cloud Services						
50667 ITS - ESS - ERP - Enterprise Resource Planning						
50676 ITS - OSS - NSD - Network & Services Design & Documentation						
50916 MOB_NEO - MAN - RO - Roll-Out						
50910 NEO - NIE - BCT - Backbone & Corporate Technologies						
50915 MOB_NEO - MAN - Mobile Access Network						
50662 ITS - CSS - OPS - Operational Support						
50671 ITS - ISS - EAI - Enterprise Application Integration						
50909 NEO - NIE - ATE - Architecture Technology						
50657 ITS - BSS - SLS - Sales						
50293 CIS - PSP - ESE - E-Solutions						
50803 APP - MST - PPR - Planning, Programs, Cost Control & Reporting						
50295 CIS - PSP - IPB - Iptv Back End Integration						
50933 NEO - RPP - DC - Datacenters						
50666 ITS - ESS - ISA - Internal Services Applications						
50656 ITS - BSS - PTA - Partner Applications						
50932 NEO - RPP - E&VHR - Events and VHR						
50908 MOB_NEO - NIE - WAT - Wireless Acces Technology						
50911 NEO - FAN - Fixed Access Network						
50906 NEO - NIE - PLF - Physical Layer & FTTH						
50925 NEO - OPP - Outside Production Plant						
50669 ITS - ISS - Infrastructure Support Systems						
50921 NEO - IPP - Inside Production Plant						
50901 NEO - NPB - Network Planning & Budget						
50905 NEO - NIE - CPE - Customer's Premises Equipment						
50668 ITS - ESS - EBS - EBU Support Services						
50907 NEO - NIE - TVL - Technology Validation Lab						
50931 MOB_NEO - RPP - RAN Remote Operations						
50805 APP - MST - NAP - Network & Service Architect., Program & Prod Experience						
50658 ITS - CSS - Change & Support Services						
50917 MOB_NEO - MAN - PR - Pre-Roll-Out						
50920 NEO - BNC - BOSO - Building & Switching Outphasing						
50000 COP - MST - Mgmt & Support Staff						
50919 NEO - BNC - PR - Pre-Roll-Out						
50913 NEO - FAN - PR - Pre-Roll-Out						
50651 ITS - SEC - Security Governance						
50927 NEO - OPP - Site Renting and LLC						
50281 CIS - SCC - Service Enabling Core & Connectivity						
50100 SDE - MST - Mgmt & Support Staff						
50674 ITS - OSS - Operat. Supp. Serv. and CRM						
50929 NEO - RPP - BCT - Business Continuity						

50288 CIS - PSP - Products & Services Platforms - Mgmt & Support Staff						
50652 ITS - BSS - Business Support Systems						
50664 ITS - ESS - Enterprise Support Systems						
50904 NEO - NIE - Network Innovation & Engineering						
50801 APP - MST - Mgmt & Support Staff						
50650 ITS - MST - Mgmt & Support Staff						
50280 CIS - MST - Mgmt & Support Staff						
50900 NEO - MST - Mgmt Support & Staff						
50928 NEO - RPP - Remote Production Plant						
50660 ITS - CSS - ISN - IT Service Desk						
Grand Total						

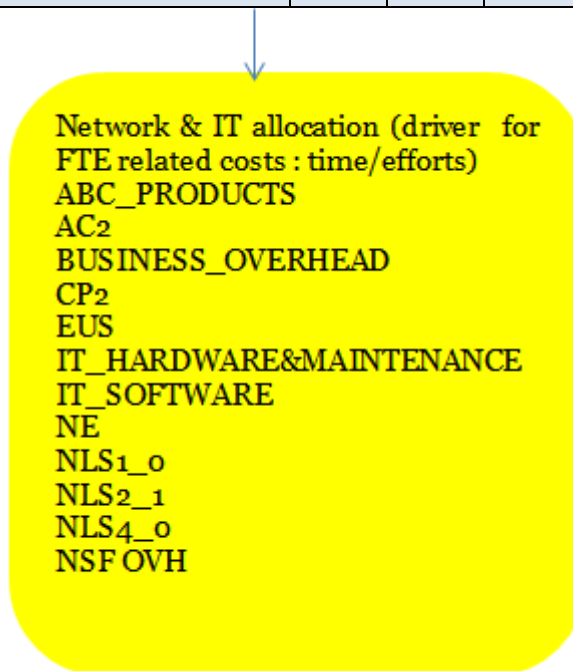

In the SDE module, the organisational groups in the above table do not only encompass the costs of GL 62 wages (including the PFA, capex manpower), but also FTE-related costs from GL60 MOS or GL 61 SOG, as well as outsourcing costs for COP field and remote teams.

In the later case, the driver is the same (based on time/efforts), but does take into account the time/efforts of both the internal & external manpower.

The allocation of the “operational” teams is done directly through the driver whilst the allocation of the “overhead” teams is done through generic keys taking into account the scope of the overhead team (driver is the remuneration cost allocation of all the teams in the scope of the overhead team).

The allocation of the “fix” part of the “operational” teams is done through generic keys (a simple copy of the remuneration cost allocation of the “var” part of the same operational team).

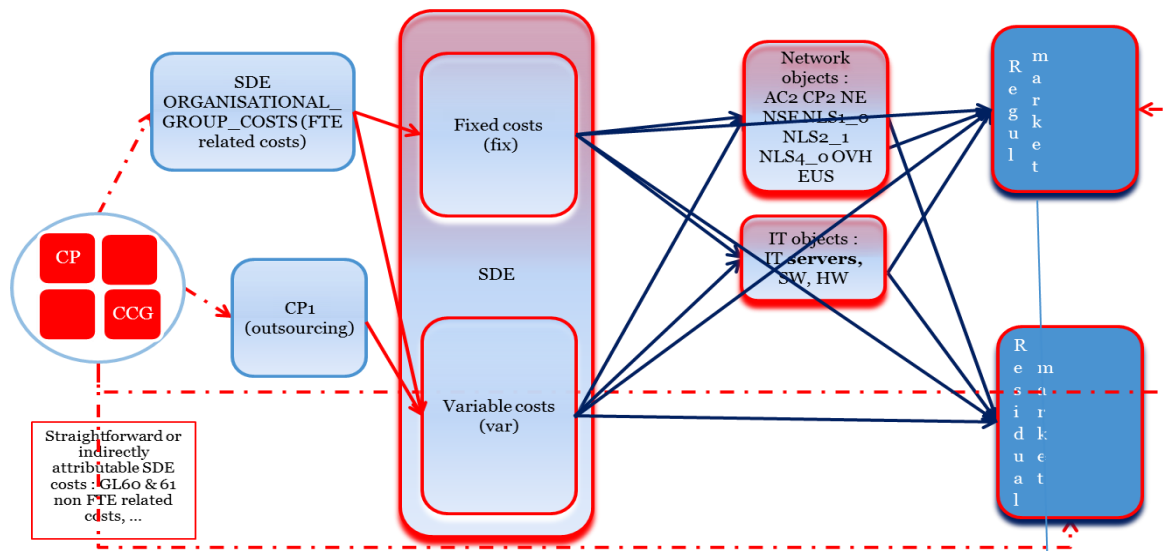

Warning : This flow overview is schematic !
 Legend : A dotted line means the allocation can take several steps (not necessarily direct) - - - - - ➔

Figure 16: SDE OPEX Flow – Fix / Var

5.2 Allocation of SDE OPEX costs not going through the “SDE” INCA module

5.2.1 GL61 accounts – Services and Other Goods (SOG)

The GL accounts in the 61 range mainly register outsourcing, consultancy, renting & maintenance costs as well as miscellaneous costs driven by staff (GSM, memberships, office material, internal events etc.).

The GL61 accounts are at a sufficient detail level to allow for a direct allocation to one of the cost objects of the allocation flow. The destination cost objects are distributed over different allocation modules :

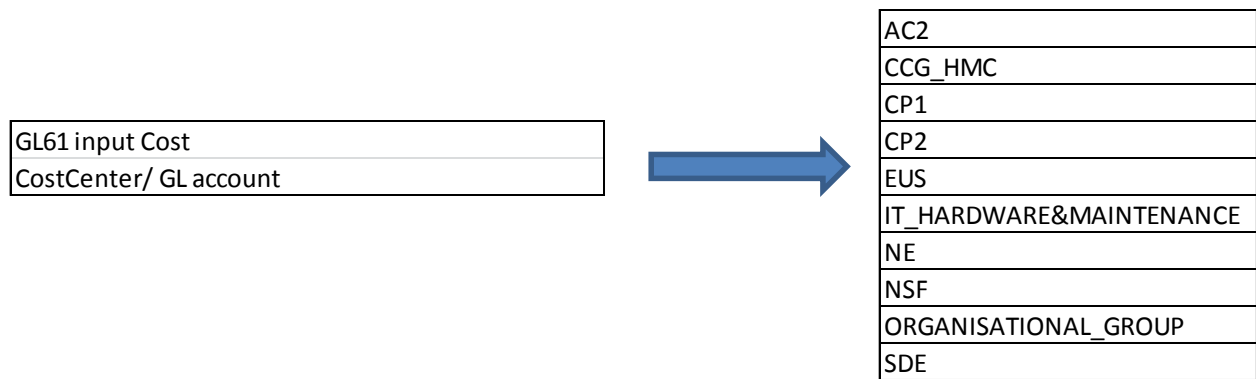
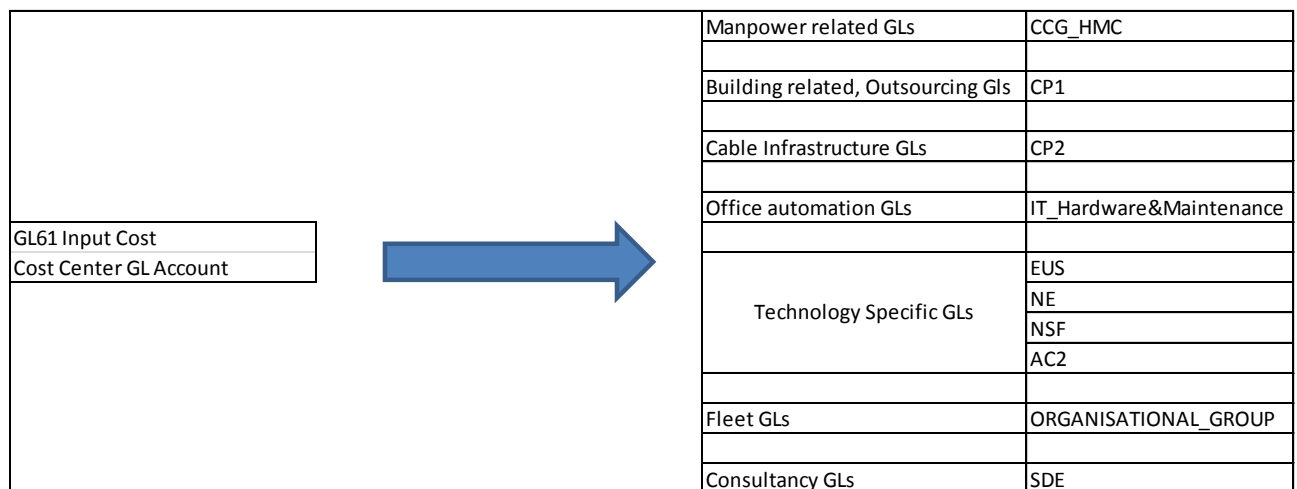

Figure 17



5.2.2 GL60 accounts – Material Out of Stock

The GL60 account costs cover the cost of all kinds of material taken out of the stocks of Belgacom and used for the repair and provisioning of network or the cost of small items (office material, GSM,...) consumed by the staff in the context of their daily activities.

Note that movements from stock also occur for the construction of the network; these costs are capitalized. From SAP-MM, it is possible to filter out the movements to be capitalized and the others. The capitalized MOS costs are implicitly treated with the assets. MOS costs are reported at CP/ GL account level per cost center.

This level doesn't always allow an accurate attribution of the costs to the model cost objects and therefore an analysis is performed at the costbase level together with detailed information out of the SAP database .

- The SAP records are reported among other detailed information such as the Material Item Number, where the amounts can be directly attributed to a cost object of the cost model based on the description of the material item.

The SAP database contains more than 600.000 records.

This analysis results in an allocation towards : network related cost pools (CP2, NE, SDE), manpower related cost pools CCG_HMC & specific market cost.

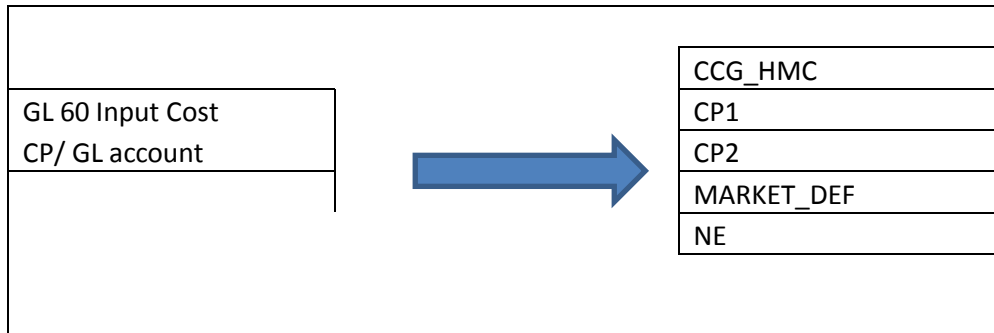

Once each material item is attributed to a cost object, it is easy to report an allocation from the CC/GL account aggregate to the model cost objects.

6 IT stream

6.1 IT delivery

6.1.1 IT allocation flow : Introduction

The IT model can be summarized by the following drawing representing the different IT Modules as defined in the IT model, as well as describing objects contained in each of them. The creation of these modules and objects will be detailed in the following paragraphs as well as how they are allocated to each market through an allocation which uses causal and generic keys created with data available in different inventories or reporting systems within the company.

ICT is the use of programs with a specific infrastructure to deliver a requested service or product to the end-user (which can be a Belgacom Client or a Belgacom Employee). In Telecommunications, rarely will we encounter an Application or a project that are exclusively used by one product or market. Most of the time, it will be used by different ones. Therefore, the goal of this model is to regroup all capitalized and operational costs within clusters of applications or projects that have been defined so that the link to markets can be made.

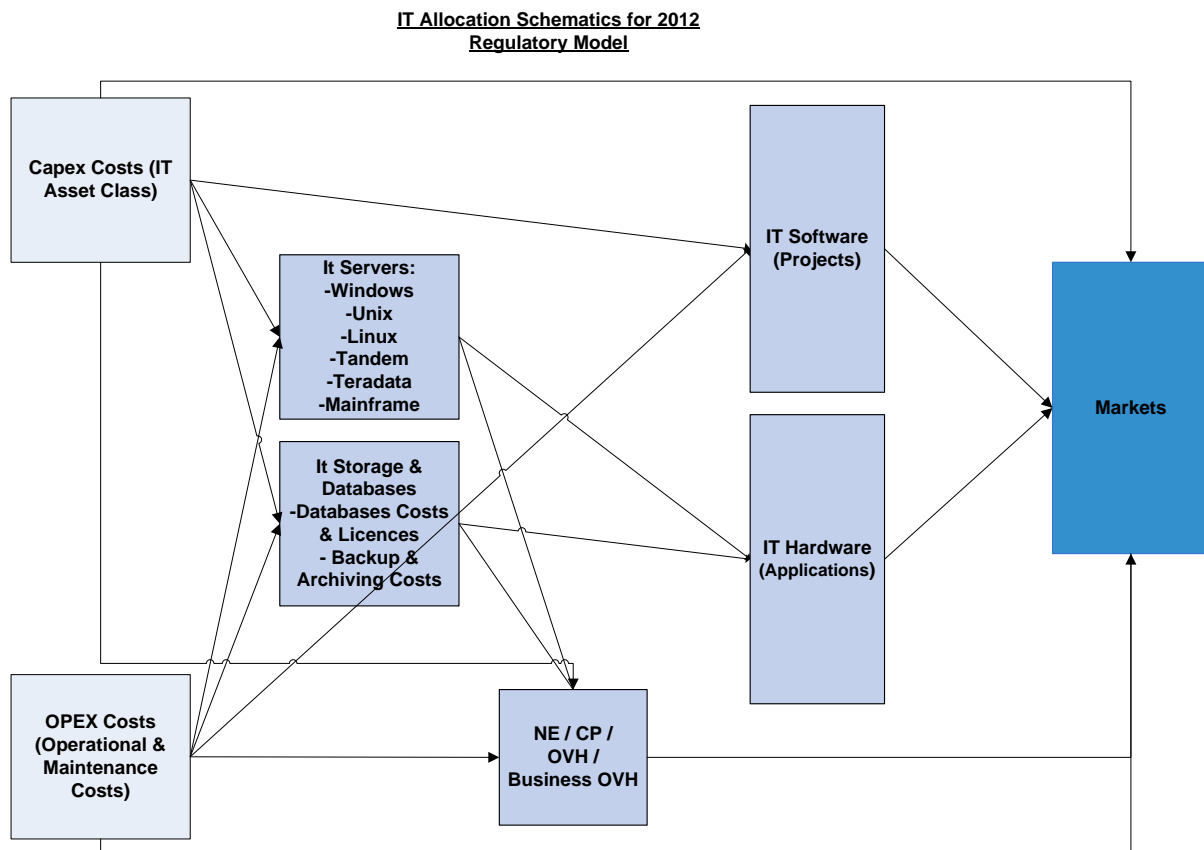

Reporting systems and inventories either report to an application and its component or to a project. For the last years, Regulatory created clusters of applications called Constellations which were dropped off since the 2011 model. All this IT information coming both from REG and internal sources allow the creation of an allocation towards the markets. The same approach was followed

for the allocation of IT software developments through the attribution of projects to the markets. The allocation stream goal is to link the costs of manpower and infrastructure that are used in order to create, run and maintain applications, components and projects to the markets defined in the regulatory model.

These costs can be of two different types: capitalized and therefore depreciated following accounting rules (for IT, depreciation length is mostly 4 or 5 years), or operational and fully charged for the current year. Depending of the cost's nature, the allocation stream will follow a different path and use different inventories and reporting systems in order to create the optimal allocation keys.

Accounting has defined, for capitalized costs, more than 130 IT assets or sub-assets which can be easily identified as distinctive IT objects in the model. Inventories and accounting provided the raw data needed in order to create the allocation keys.

6.1.2 Data sources: IT Inventories and Reporting Systems:

Infrastructure and Hardware Inventory:

The hardware layer of the IT Infrastructure within Belgacom is composed of a server park, a storage facility and an intranet required for interconnection. For Servers allocation, two inventories were used to populate the park and gain depth in their use. WMC³ and Sun:bc for UNIX are databases maintained by IT Engineering. Regarding Storage, the weight of databases from different technologies is used as the allocation driver.

Internal IT Databases:

The main database used in the model is the "Configuration Management Database" (CMDB) which populates and links together all IT related objects in Belgacom, such as which databases are used by an application, or what is hosted on a server. This is used primarily for incident management.

IT Asset Manager (ITAM) is the inventory for all IT equipments with a reference to its cost and is used by Finance to calculate yearly the costs for IT hardware Assets.

ARIS is a recent initiative to install a business process modeling tool which allows the aggregation of applications and to understand fully their purposes.

Reporting Systems:

Rapid⁴ is a tool used for projects, budget and capacity management related processes, with interfaces to other core systems such as SAP HR (human resource & organization units data) , SAP Finance (actuals, purchase order...), IMD (release Management) and timesheets applications (used by SDE to report their day-to-day work). Rapid will be used to calculate allocation keys for most manpower costs for SDE regarding both Capex (allocation of Assets ranging from 2526 to 2573) and Opex.

³ Windows Management Console

⁴ Repository for the Administration of Projects and Initiatives in a Decentralized way

Regarding maintenance and contractors, the data is no longer maintained by the vendor management team. Rapid is therefore used for both these allocations.

TM1 is an interface from excel to SAP allowing the extraction of Data coming from Finance and HR. It was used to complete the RAPID data which lacks the 2008 year and most of the non-workload costs.

6.1.3 Modules and Objects composing the IT allocation flow

IT Servers

A server is a set of hardware running as a service to serve the needs or requests of others programs or users. They are bought off several vendors which use different technology types. These machines are upgraded on a frequent basis in terms of memory, CPU cache and quantity or i/o cards. This results in a heterogeneous park of servers, even for a similar model sold by the same vendor, having a negative effect in terms of cost variance. Hence was followed an approach which splits the servers into families based on their technology as firstly, it matches the operational organization within Belgacom, helping in coherence and giving the opportunity to have for each family an expert available to help, backed up by dedicated inventories. Secondly, families follow a logical flow of cost allocation. Windows machines can be split in two categories (physical and Virtualized) to which we apply a weight based on their raw cost in order to give more consistency to the data used. This is done because the variance between servers in these 2 categories is much lower than by taking the whole Windows family as a whole. For Linux servers, the homogeneity allows for an allocation without weighting each machine. For Unix, the same approach as the windows allocation was followed without using weights per machine. Finally Teradata, Tandem and Mainframes machines will be directly allocated to the applications that use these special technologies.

Splitting the server asset between these families was achieved by using the cumulated purchase costs of these families which is provided by Finance. This calculation is made possible by the inventory maintained in ITAM.

a) Windows family

Windows is split between three categories: Physical and Virtualized servers. Virtualization machines use a software layer to emulate more (virtual) servers with the possibility of using different operating systems or environments, helping to rationalize resources (by allowing more redundancy, saving space etc.). Weights were created from the cost model made by IT engineering and purchasing costs for physical and “VM Performance” servers were used. The key to allocate windows costs is based on the number of servers multiplied by its corresponding weight and the destination is either another object from the model or, generally, an application.

b) Linux Family

Historically, Linux supports applications and processes related to the residual market (98% in 2010).

c) UNIX Family

The Unix allocation follows the same method as the Windows family without weights.

d) Teradata and Tandem Families:

Teradata are servers specifically used by the Data Warehouse and will be directly allocated to the corresponding cluster (DWH).

Tandem machines are non-stop servers for the Customer Billing application and will be directly allocated to its corresponding cluster (COB).

e) Mainframes family

Mainframes are used by a small group of specific applications and will be allocated according to an IMA key based on the number of users for each application using directly mainframe resources.

Storage

In the storage tool, reported directories paths have been assigned the name of an application or a database in their path. It allows us to know precisely the amount of storage used by each application, database or another object such as Websphere in interconnection. These are the most intensive objects in terms of storage. In order to allocate costs from databases to applications, we used a report from each database family operational team (Oracle, SQL, Teradata and IDMS) to map databases with applications and to create allocation keys based on the total size of the databases used by each application.

IT Hardware & Maintenance:

The Hardware & Maintenance module summarizes all costs related to the hardware infrastructure as well as specific maintenance contracts that are regrouped mostly by applications, even though if they concern hardware. All applications that receive any cost from servers and storage are found in this module. There are 3 specific cases which are detailed by the following:

a) Connect IT:

Connect IT is the Intranet used by the IT infrastructure in order to inter-connect the different objects it uses to deliver a service. The allocation will be based on a post-process generic key defined by the CAPEX Software investments for the last 5 years and OPEX from 2012.

b) Application Interaction Platform:

The Application Interaction Platform object is defined as the software layer required to inter-connect Belgacom's complex IT infrastructure. Websphere and middleware costs compose most of this object. Websphere Application Server (WAS) sets up, operates and integrates electronic business applications across multiple computing platforms allowing real-time application integration, event-driven processing and process automation. A middleware is a software component that provides interoperability in order to support and simplify complex distributed

applications. It is an intermediary layer between application software working on different environments or operating systems. This object receives mostly costs from either middleware or websphere licenses, upgrades and the infrastructure costs it uses (mainly storage and servers). The same generic key as Connect IT is used to allocate application interaction platform.

c) IT Overhead

The overhead object is a pool of costs that manages the Belgacom's IT Infrastructure. It is internalized in the IT model by the use of a generic key based on the IT_Software module allocation on OPEX costs from BA 50.

IT Software:

The IT Software module summarizes all the IT CAPEX costs from the last 5 years and the OPEX costs from 2012. It pools all software development costs and excludes network costs, which will follow the network allocation stream.

In order to give more consistency to the allocation, we regrouped some projects into two different clusters that will follow a particular generic allocation:

a) Non development projects:

Non development projects relate to existing support projects in which employees or contractors book their activities when they are not involved in a development project. It represents mainly support projects which exist due to investment projects. It is allocated by a generic key based on the IT Software module CAPEX costs from the IT Assets only and the OPEX costs from BA 50.

b) Release OPEX projects:

Release projects are directly dependent from other projects since they are used as support as well. Release CAPEX projects were directly internalized through the allocation process while the OPEX ones will follow a generic allocation key.

c) SW Application Interaction Platform

Allocation Process for IT Assets and Operational Costs:

IT Assets allocation:

- **2500 Servers (Inclus. Tandem)**

Servers can be used by applications (software sold by a vendor or developed in-house) and databases or for interconnectivity and security. This asset pools most of servers families used within the company such as Windows, Linux, UNIX, Teradata and Tandem technologies. Accounting distinguishes the following families: Wintel (Windows for Telecommunication), UNIX (with Linux pooled in this family), Teradata and Tandem. Keys are created from Finance split in

order to allocate costs to each family, which will be treated distinctively, following a specified allocation path depending on the technology.

Windows servers are allocated by applying a weight to the number of servers used by each IT object. These weights are calculated by using a cost dependent ratio based on the raw purchasing costs of a windows server. We distinguished three categories of windows servers that reduce heavily the variance within the windows server family: the low-end, the high-end and VM-performance servers. Low-end machines are composed of most servers in the windows family. High-end ones are the latest end-entry models which generally use twice as much CPU's and memory than a low-end server. VM Performance machines pool the servers that are used to emulate more servers with a more powerful hardware than the last two categories.

Regarding the Linux family, all costs were allocated to the Residual Market. Tandem and Teradata are both allocated directly to their corresponding application: Customer Oriented Billing (COB) for Tandem and Data warehouse for Teradata (DWH). By definition, they will directly contribute to the Residual market as well.

Mainframes costs are distributed equally between the 7 applications that use this technology (ABD-FH, ABD-NFH, ABR, AGS, ASR, ITC and ITR).

Finally, UNIX costs are allocated to other IT objects by using the same approach as the windows allocation.

Server Module
Allocation Flow 2012:

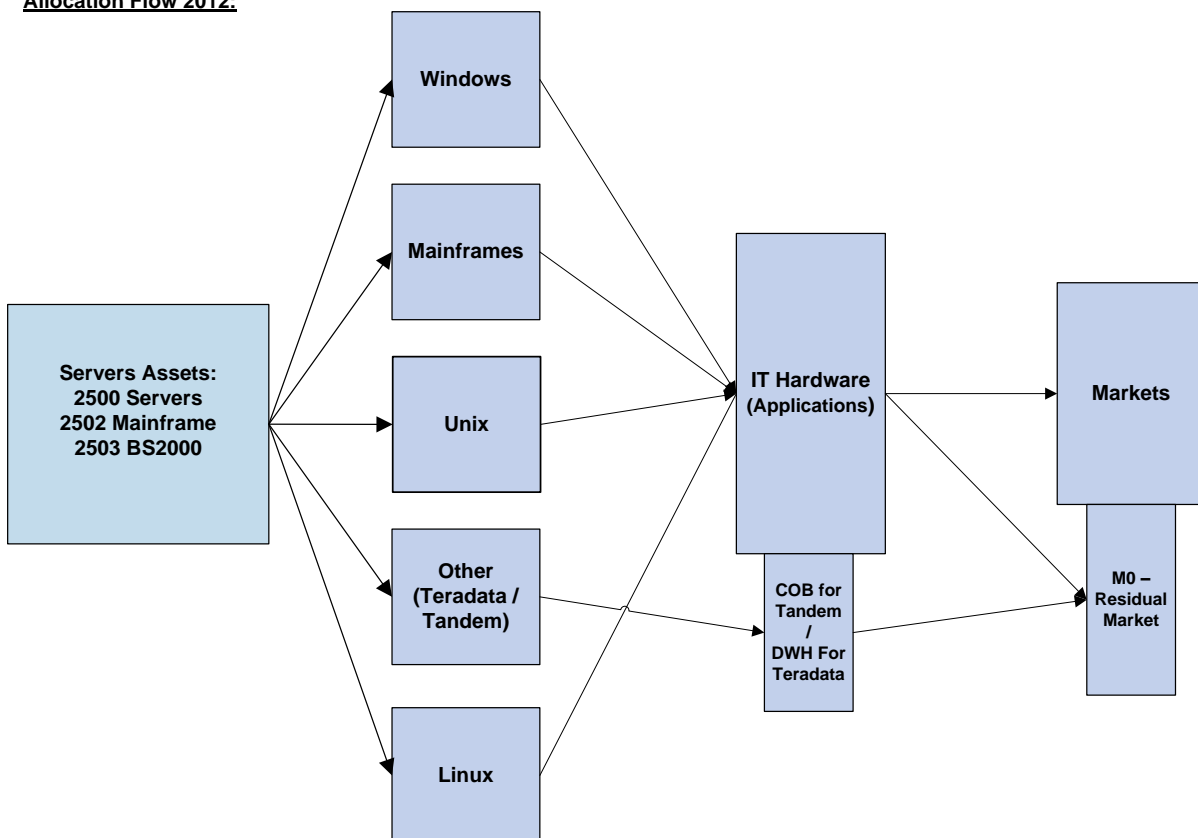

- **2501 Storage:**

Storage for Belgacom is both a core business as well as a support for employees and customers. It is required in order to run applications and databases, create backup and archives to save an employee's work or a customer's information (regarding billing or call details records for instance).

- **2502 Mainframe BS2000 HW & 2503 BS2000 Software:**

Mainframes are powerful computing platforms used for critical applications. They can be considered as multiple servers within one machine. Sensitive applications and data that require heavy computing power are hosted on them. It requires specific software to run which costs are pooled in the 2503 BS2000 Software asset. The mainframe park has been updated to the Z-Series designed by IBM.

- **2504 IT Internal Network**

IT Internal Network is an asset representing Belgacom's Intranet, required to support the needs of employees as well as the interconnection needed in order for the different IT objects to communicate.

- **2505 Office Automation**

Office Automation pools IT costs and improves productivity such as development environment, printing servers etc.

- **2506 End user IT Device**

Concerns IT material made available to Belgacom's employees such as laptops and desktops. It is an office automation cost.

- **2509 HW Usability Lab:**

Testing equipment and software for IT is pooled in the usability Lab. The 2509 asset concerns hardware and 2545 is related to software. As it concerns all applications within Belgacom, this cost is considered as a Business overhead and will be allocated as such.

- **2520 System Software:**

System software is an asset for some specific database and middleware applications costs (websphere for instance) and licenses of some IT applications running on Ethernet MPLS and (D)WDM equipment. Database is an object within the "IT_Storage&DB" module and middleware is a main contributor to the "Application_Interaction_Platform" object. In order to split the costs, the capex costs for the year 2012 were used from SAP records in Asset Accounting for all booked projects related to this asset.

- **2523 Major Software Application:**

This is a specific asset that pools applicative mobile costs. It contains IT sub-assets as well as network ones due to historical reason. Each element can be identified in terms of type (IT / Network) and costs (distribution per sub-asset) and allows to allocate them individually.

- **2525 Application Software Other:**

Application Software Other is an asset for all Capex licenses costs that are not pooled in another IT asset (licenses costs for minor applications for instance). It is heavily related to applications and office automation as it is composed of licenses for antivirus, to a software package sold by an external vendor and used by an in-house core application such as our Order Management System (OMS) or statistical and databases manager for our data warehouse department. In order to allocate this key efficiently, the number of logical machines (physical and virtual) from each server related family was used as a means to ventilate these costs through the server allocation process.

All following assets (2547 excepted) are related to specific software development and will follow a specific allocation in order to pool all costs to the IT Software module. The key consists of a 5 year CAPEX study of the cumulative investments per project for each asset. Explicit projects are copied in the IT Software module with their full name while non-explicit projects are pooled within dedicated objects such as: “non development project”, “Release” projects and “SW Application Interaction Platform”.

- **2526 Applic SW IMA:**

All costs related to the **Identify Management (IMA)** application are assigned to this asset. IMA is composed of 6 components (Core, Employee, Dealers, Customer, Module, and Management) that identify all Belgacom users.

- **2529 Appl SW Middleware:**

Although named Middleware, this asset is composed of special applications that play the role of a middleware inside Belgacom’s IT infrastructure. It has to be distinguished from some costs objects in System Software and Application Software Other that also have middleware costs such as Websphere licenses. This asset pools IT domains from:

- A **Business Process Modeler** which delivers a process integration platform for enterprise services based on service-oriented architecture.
- A **Service Oriented Architecture** layer.
- A **SOA Services Repository** to document and describe all SOA services.
- And a **Hub Contract Software** used as a middleware connectivity tool.

- **2530 Applic. SW PILA:**

Pila Asset is composed of more than 20 applications and components related to the **Order handling Management System (OMS)** with all its bridges with provisioning systems and a customer relationship management interface with BCI as well. OMS is one of the main contributors to this asset, as is the **Network Provisioning System** linking OMS with provisioning systems and the **Order Flow Application** (an interface between BCI and OMS).

- **2531 Applic. SW BCI:**

The Belgacom Channel Integration (BCI) is a customer relationship management tool for all call-centers. This asset is composed of 15 components -enabling a real-time customer information input or output in order to improve the feedback a customer receives when calling Belgacom's helpdesks.

- **2532 RID(Reference Inventory&Design):**

RID is an asset related mostly to inventories and documentation that are used in different processes as it pools 6 different Domains.

- **2533 Applic. SW WFMS**

The **Work Force Capacity Management** tools (WFM) asset is composed of 23 applications which automate the dispatching on the field of all Belgacom's technicians including a scheduler and reporting system.

- **2534 Applic. SW UTS**

The **Unified Trouble Ticketing System** (UTS) is a system used in order to register and follow-up trouble tickets pro-actively and reactively.

- **2535 Applic. SW Cust Relationship Management**

This asset is composed of two applications related to the selling process and are directly linked to CRM: **Customer Sales Assistant (CSA)** and **Customer Value Management (CVM)**.

- **2536 Appl SW COB**

This asset pools costs from the **Customer Oriented Billing** system (COB), composed of 24 applications that are mapped on 3 different domains: **Customer DataBase (CDB)** **Intercarrier Billing Information System (IBIS)** and the **Call Details Records Flow (CDRFLOW)**. Billing data is a sensitive matter for both customers and Belgacom and requires real-time redundancy. Therefore, COB applications are hosted on dedicated technology: Tandem servers also called "Non-stop servers". The CDB Application is retail related, IBIS wholesale related and CDRFLOW applies to both.

- **2537 Appl SW SAP**

The SAP Asset pools all costs coming from all modules used by Belgacom.

- **2538 APPL SW-Number Portability**

Number Portability is composed of two main applications called **Fixed Number Portability (FNP)** and **Carrier Pre-Selection (CPS)**. CPS is an important system as it is an interface with olo's requirements to deliver their services. As for FPS, it is a domain exclusively used by Belgacom.

- **2539 Applic. SW ECA/ECM/VORTAL**

E-Channel Applications (ECA) and **E-Content Management (ECM)** are tools to manage and web-enable digital content for consumers (B2C) or enterprises (B2E). These are websites to engage customer relationship in order to conduct e-business via the Belgacom websites. 40 applications are stored in this asset and regrouped into 3 IT domains.

- **2540 APPL SW – ROSY**

ROSY is a core component of the IT infrastructure as it is the runtime engine for SDH, XDSL and ITDV provisioning and repair.

- **2541 APPL SW – NETCAM**

NETCAM is a dedicated asset for Rosy's workflow engine for SDH (BPEL).

- **2542 Sales Handling Engine(SHE)**

The **Sales Handling Engine (SHE)** is a sales application used as a layer in order to enable convergence between all selling applications so that our vendors and partners will have a global view on all products supplied by Belgacom Group, improving order intake and rationalizing the IT selling infrastructure. Pre-Sales and Sales are activities in the fulfillment process hence being mostly allocated to the residual market.

- **2544 APPL SW -IT Security**

IT Security asset pools heterogeneous costs that can be related to applications (NFM – **New Fraud Management**) and IMS (Identify and authenticate for provisioning engine), buildings (physical security), to even Skynet Costs to protect user's privacy or overhead costs to protect the IT infrastructure from malicious harm (virus, pirate take-over etc.).

- **2545 SW Usability Lab**

This asset will follow the same allocation pattern as the 2509 HW Usability Lab and all costs will be sent to the business overhead object.

- **2547 Major software applications**

Major software applications are assets regrouping all new IT developments and applications since 2010.

- **2550 APPL SW ABC**

The **Access Backbone Connectivity asset (ABC)** is a core element of Belgacom's infrastructure. SRW is an inventory for connectivity and equipment documentation and is used as an interface between 3 IDMS Applications and front-office applications such as OMS, WFM or COB/CDB. Three other core domains are also pooled in this asset: ABR for the local loop connectivity and managing resources and services. ANA (**Automated Number Assignment**) supports service order provisioning of phone numbers through automation of the attribution of a phone number to a customer. Finally, ITR (**Infrastructure TRansmission**) is the inventory of Belgacom's backbone and optical network covering leased lines, physical equipment, trails, trunks, cables and the multiplexing hierarchy between all these elements. It should be noted that applications grouped in this asset use a special hardware in order to run properly as they are all linked to huge databases

that require daily processing of data per batches. For the last years, BS2000 mainframes from Fujitsu were used but they were recently replaced by Z-Series from IBM⁵.

- **2551 Operational Inventories**

Operational Inventories are applications used to maintain ATM, DSLAM, Ethernet and IP inventories and statistics.

- **2552 GraphDoc**

The Graphdoc asset pools all graphical documentation components which are tools used to create or modify the local loop network documentation. It allows an integration of the Autocad package which is drawing software.

- **2561 APPL SW – NETCOOL**

Netcool is a software package sold by IBM and developed internally to suit Belgacom's needs. It is a set of alarms and probes used for monitoring to ensure both a pro-active and reactive service assurance process. It is divided in two main domains: **Netcool Transmission (NCT)** and **Netcool Data (NCD)**.

- **2562 APPL SW - e-Health**

E-health is a reporting tool for bilan and is composed of 3 domains: e-health (A-EHT), Provisioning (A-PRO) which is an interface between e-health and umbrella/CMS and oblicore service layer (A-SLR). These domains are allocated to the service assurance of Explore products.

- **2563 APPL SW-Customer Remote Support**

Applications used by the helpdesks or customers through the Belgacom portal.

- **2566 APPL SW-DIAMON&CORRELATOR**

The diamond (DIA) and Correlator (CRL) asset regroup those two IT domains that enable the monitoring of network alarms. It also creates tickets to respond efficiently to problems.

- **2567 APPL SW – DARE**

DARE stands for **D**iagnose **A**nalyze **R**epair **E**ngine and is the main tool to analyze alarms and probes reports. It diagnoses problems through a root analysis, classifies incident by priority and forwards them to responsible persons for problem resolution.

- **2568 APPL SW-Learning & Mngt Syst.**

The learning management system asset is essentially a component of SAP HR (or SAP LMS for **L**earning **M**anagement **S**ystem).

⁵ One IBM z10 Mainframe is supposedly 1500 times more powerful than regular x86 servers while consuming 85% less power (source IBM).

- **2569 APPL SW-ECRM**

The E-CRM asset contains one application named **Group Content Management (GCM)** which is a platform for contract, records and business process management.

- **2570 APPL SW Business Intelligence Tool**

All costs from the Microstrategy software are sent to the Business Intelligence Tool asset as the main software used by our business intelligence department (which is the Data Warehouse: DWH). It is heavily related to data warehouse and will be grouped with it so that the tools they use are represented in the total cost of the data warehouse. Business Intelligence costs are mainly allocated to the residual market.

- **2571 APPL SW ONE-Catalog**

Asset pooling costs from the **Belgacom Product Catalog (BPC)** which is an application that stores advice and information about all products and services.

- **2573 Appl SW DWH**

The data warehouse department has heavy requirements in terms of hardware and software as it calculates statistics and indicators for Belgacom's products and network. Data warehouse uses a special hardware from the Teradata technology that helps with the treatment of large data volumes with the possibility for many users to analyze them.

All Assets from 2526 to 2599 are Software assets and will be allocated through a project analysis from a scope of costs going over the last 5 years. All costs distributed between these projects were linked to a specific market or group of markets. The following schematic represents a set of examples of the Asset allocation to the markets:

In order to make sure that the scope of study is complete, the use of different sources was mandatory. As Belgacom's reporting tool only dates back to 2009, it lacks the information on costs from 2008 and specific costs from 2009 to 2012 such as licenses, Adapative maintenance, actuals others, fixed price and specific IT hardware that was not capitalized in an IT hardware Asset class.

The following table summarizes where the data used comes from:

Cost Type	Source
2009-2010 Workload	RAPID
2009-2010 Non Workload	TM1
2007-2008	TM1

Operational Costs:

There are 4 sources of IT opex costs:

A) Maintenance related:

Maintenance costs are regrouped into 2 different cost pools (61120 and 61130). RAPID was used to create allocation key, distributing these costs towards servers, applications within the Hardware&Maintenance module, storage and NEs.

B) OPEX Wages internal

Internal wages for IT OPEX costs were allocated by the use of the RAPID database. A report by cost centers giving a detailed output of OPEX projects was linked to the cost centers groups from the cost base allowing an allocation from all IT teams to the projects objects from the IT Software module in 2012.

C) OPEX Contractors Fixed Priced:

RAPID makes the distinction between employees and contractors and also between the different contractors types (fixed price, body shopping etc.). This precision allows us to create specific keys for contractors in the same way as it was done for internal employees, by allocating their costs to the different projects they contributed in 2012 via the RAPID tool.

D) OPEX Contractors Bodyshopping

The same principle was applied for bodyshopping costs allocation as for the fixed price ones.

The following drawing recaps the IT cost allocation for OPEX wages:

IT cost Allocation Flow
OPEX Wages (2011)

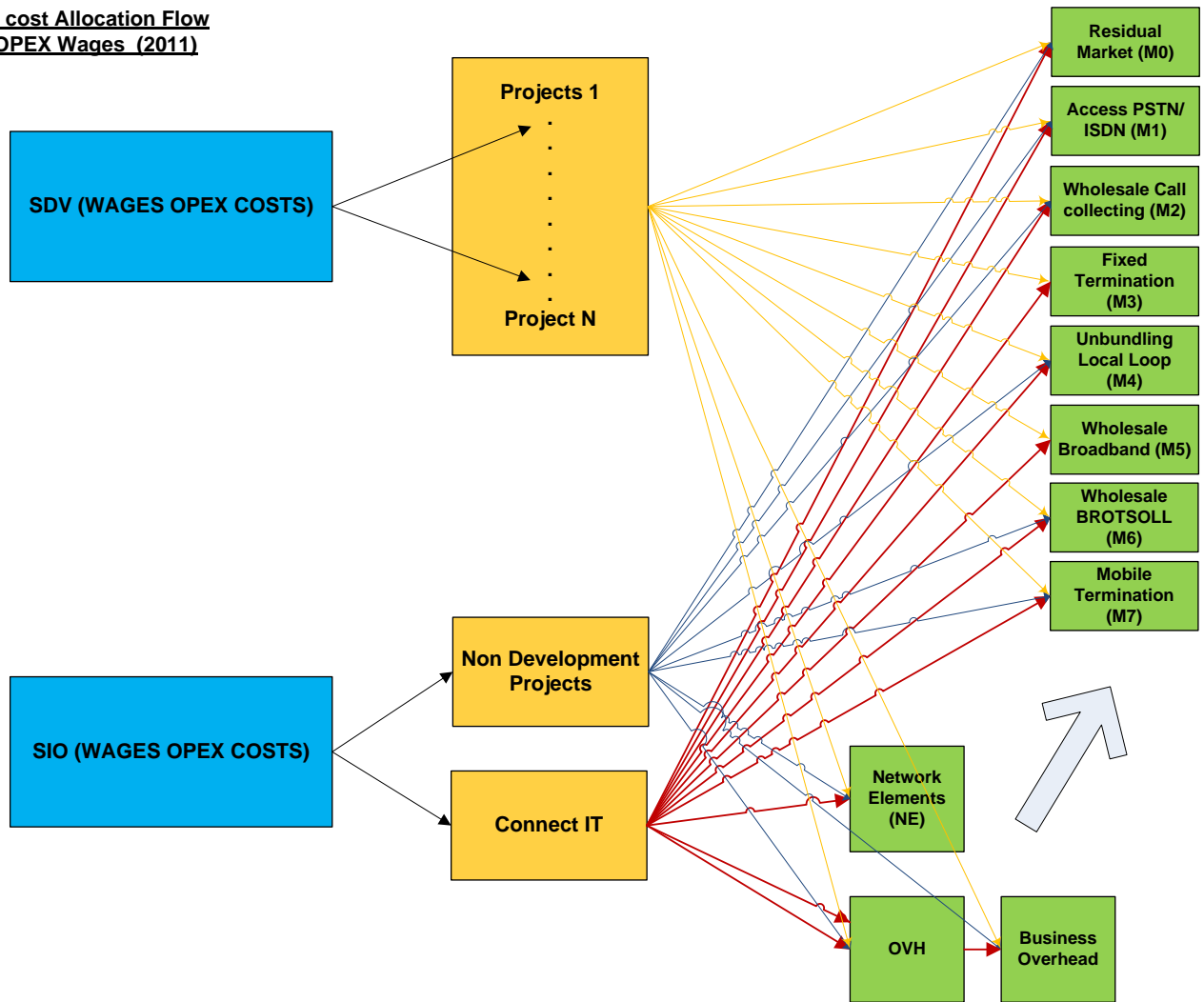

Wages OPEX Costs are allocated using RAPID as a tool for the creation of allocation keys for each cost center within ITS and CIS. Reports are designed in order to regroup OPEX costs on the 2012 projects in the IT_Software module. Regarding the CIS IT teams, a special allocation was made as some of these teams are focused on supporting IT development, therefore reporting most of their resources on support projects that are by definition hard to allocate to specific markets. Maintenance Costs is the other main source of IT operational costs and can be related to server's or storage maintenance or to IT Development in case of applications bought off the shelf. The maintenance cost allocation can be represented by the following diagram:

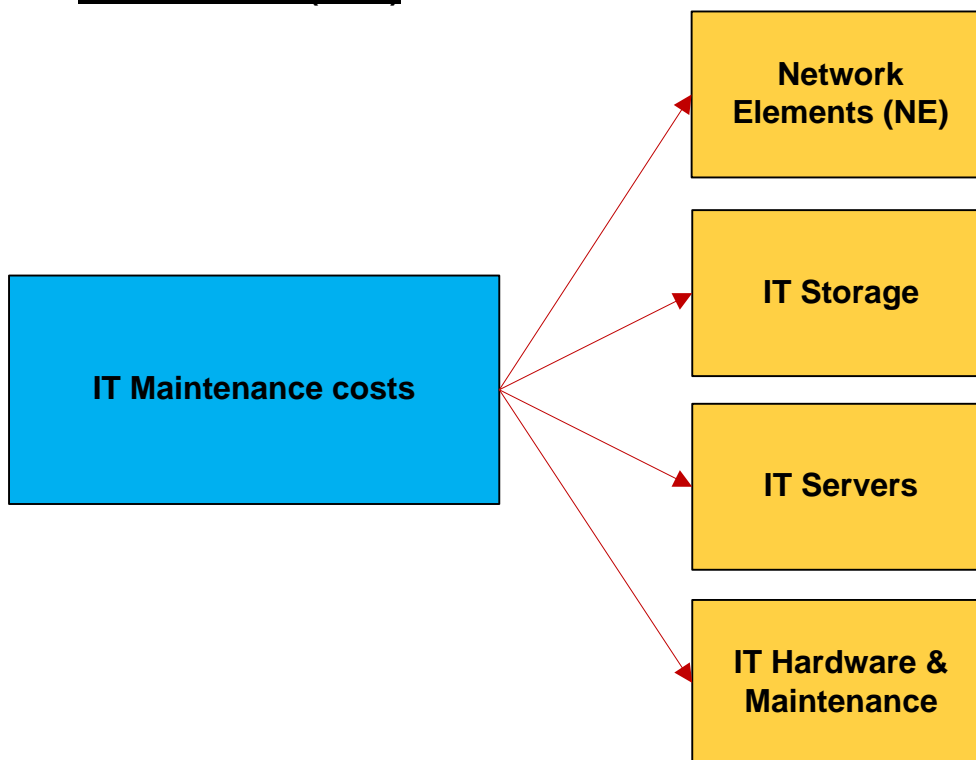
IT Maintenance cost allocation flow (2011)**6.1.4 Applications to Markets****a) IT Applications**

The IT applicative layer is composed of applications or software being used by either an end-user (such as an employee or a customer) or by a service (such as an inventory or a billing system). There are more than 1000 applications that have been bought off a vendor and adapted to suit the company's needs or developed internally by Belgacom's IT developers. Over the years, these applications have been updated, replaced, renamed or out phased.

b) Markets

Through a careful analysis of each application and project, a mapping table was defined in order to create a link between applications and the impacted markets. Most of them relate to the Residual Market, some were directly developed in order to support a specific market resulting in a direct allocation towards this market. But in most cases, an application was developed for a group of markets. An allocation key is needed to distribute the costs of these applications. Being application underlying hardware costs, the driver used is a proxy of the transactions processed by these applications, namely the provisioning volumes. More details on the volumes used are provided below.

6.1.5 Projects to Markets

In the same way as for the applications, the whole project we took into our scope of analysis was linked to markets as well. Based on the projects name, we are able to categorize them between development and non-development projects. For non-development projects, a special object in the model was created to regroup them: the non-development project object. For particular projects such as the ones named as “Releases”, a special object was defined as well to regroup and treat them as a generic allocation as well.

For development projects, a careful study of each of them allowed the creation of a mapping table between all projects defined and the markets. The non-regulated products (of the residual market) receive a high amount of the development project costs. However a non-negligible amount of development projects introduce features and enhancements from which regulated products also benefit. For instance, a project investing in an xDSL capacity upgrade enhances retail products as well as regulated products. For such projects, an allocation key is needed to distribute the costs. Being software development costs, the driver used is the subscription volumes (except for software contributing to traffic products where usage minutes are used).

6.1.6 Allocation to Markets of IT costs that are common to several Markets :

In order to allocate all IT costs regrouped in the Hardware&Maintenance and in the Software module, two different drivers were taken into account: the provisioning volumes for hardware allocation and the subscription ones for software.

Calculating these volumes is quite straightforward for the regulated markets. For the residual market only the volumes of corresponding services are taken into account. With access regulated markets, access retail products of the residual market are considered. With fix traffic regulated markets, only fix retail traffic volumes are considered.

7 Network stream

The network allocation stream is organized around the network investment structure (leading to network functional blocks in the allocation stream). The focus is on Capital Expenditure costs which are directly associated with the network equipment deployed ; these costs originate from the assets accounting system of Belgacom and they are gradually cascaded by means of a variety of cost deaggregation keys and a variety of cost drivers up to the telecommunication services. By contrast, the SRW stream focuses on the operating expenditures of the business activities, which are directly allocated to end- markets by means of business drivers.

For the operating costs of the network itself however, an intermediate allocation approach is used : the remuneration costs and the personnel related OPEX costs are associated to typical network activities (as described in Chapter 5) which are finally attributed to network functional blocks . This part is discussed in section 7.3 hereafter .

7.1 A layered allocation model

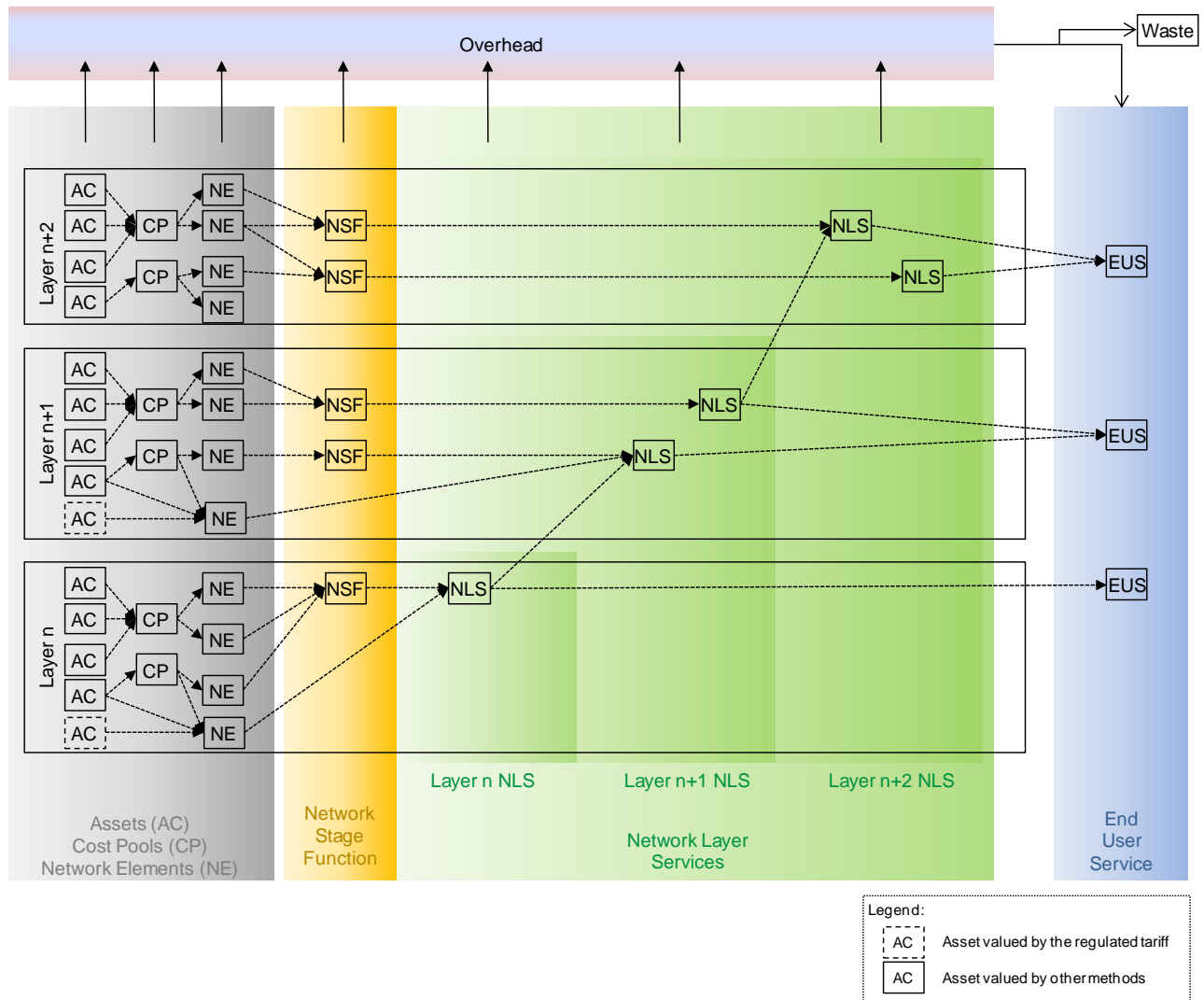

Figure 18: Layered allocation model

It is common practice in the telecommunication industry to separate investments in different logical levels, lower levels corresponding to basic (simple and general purpose) services, higher levels corresponding to complex higher valued and purpose oriented services. The pursued effect of such separation is to promote the reuse of basic lower level services by higher level services thereby bringing in the short term the volumes at each layer to levels that benefit from economies of scale. In the long term, the pursued effect is to benefit also from economies of scope.

The network cost allocation model is designed to reflect the layered functional structure of Belgacom's telecommunication infrastructure, each layer offering services to the upper layers. In practice, 5 layer levels are represented in the cost allocation model in order to allow each invested technology to be situated at the right level of its contribution in implementing the layer services.

In practice, a network equipment may participate to several different layers especially in the interfacing boards towards other network equipment because it acts as a terminating point of lower level layer services; for example an IP router interface typically implements ATM specification (for the ATM Virtual Circuits terminating in the equipment) as well as SDH specification (for the termination of Virtual Containers transporting ATM Virtual Circuits).

To avoid any ambiguity, a network equipment will be considered as belonging to the highest layer implemented in it and operated by it. For the example of the IP router, this simple criterium locates an IP router on the third layer (IP layer) above ATM and SDH.

Using this criterium all investments still in service of Belgacom's infrastructure are distributed in one of the following layers:

Layer NLS1.0 : Passive infrastructure gathering investments in access copper, in ducts and fibre cables (access and backbone).

Layer NLS2.0 : Active transmission infrastructure based on Time Division Multiplexing technology gathering investments in PDH, SDH.

Layer NLS2.1 : Active data infrastructure based on Packet Based technology gathering investments in ATM, Ethernet/MPLS.

Layer NLS3 : Active data infrastructure based on IP technology gathering IP routers, IPVPN routers.

Layer NLS4.0 : Active application infrastructure based on a variety of technologies gathering applicative equipment like telephony digital switches, VoIP platforms, Intelligent Network platforms, Broadcast TV platforms, Video on Demand platforms.

In the model layers are represented by a number of "standard" services (referred to in the sequel as Network Layer Services – NLS) offered to upper layers or directly used as retail/wholesale products (End User Services – EUS). In turn the services offered by a layer are the result of the combination of layer specific functions (referred to as Network Stage functions – NSF)* and services offered by lower level layers allowing the layer specific functions to interact with each other.

*Note: Except the following Network Elements that receive assets cost valued by the regulated tariff. Those Network Elements include network stage functionality and directly offer services of the same level as their's or upper layer services. The driver used is "yearly direct CAPEX cost". The driver "yearly direct CAPEX cost" is in fact a by-product of the valuation exercise done for the assets valued by the regulated BIPT tariff.

For the asset valuation exercise a full integration of all the asset valuation components of the relevant technology was necessary (see paragraph 3.5.2.6.4), but in the case of the calculation of this driver the required aggregation degree is determined by the allocation key to be calculated.

The inventories used as input for the asset valuation contain many details allowing the grouping of the costs components based on any combination of such aspects.

Therefore, the driver “yearly direct CAPEX cost” refers to the sum of all the relevant technology valuation components from the appropriate models that meet the allocation requirements (for example, usage of the link or bandwidth or bandwidth and service span or concerned network layer...).

Due to the method used for the valuation of the SDH, the “yearly direct CAPEX cost” allocation driver for the NE_PDH SDH equipment can’t be calculated as referred above. Instead it is calculated as the incremental SDH cost of the service for which the allocation is being computed.

Incremental costs of one service are those costs that are avoided by not providing that service. See Figure 19 for an example specific to this context, where:

- the cost incurred by all the SDH services equals the SDH asset value, resulting from running the “consolidated transport BROTSOLL engine” (see paragraph 3.5.2.6.7 Transport PDH/SDH valuation) with the full set of services carried over SDH
- the cost incurred by an SDH network carrying all the SDH services except service X is the outcome of the dimensioning and costing done by the “consolidated transport BROTSOLL engine” when having as input all the SDH services but service X.
- the SDH incremental cost for service X is calculated as the difference between the two above costs

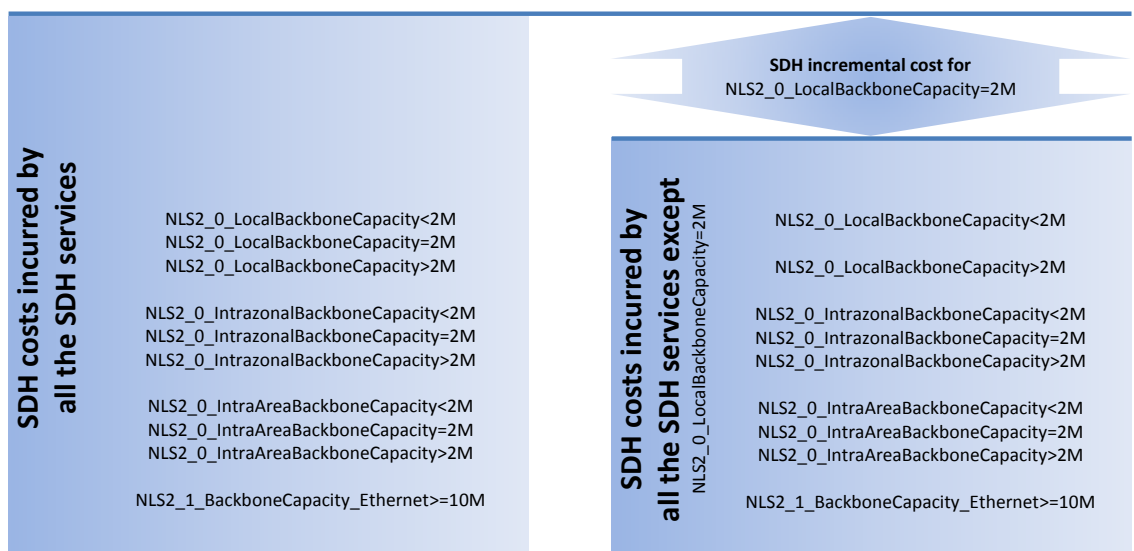

Figure 19: Incremental SDH costs calculation method, an example

NE receiving assets by the regulated tariff	offered services
NE_(D)WDM equipment	NLS2_1_LocalTailCapacity_Ethernet>=10M NLS2_1_BackboneCapacity_Ethernet>=10M NLS2_1_Backbone_MulticastVPLS_IntraRegion NLS2_1_Backbone_UnicastVLAN_Transport_IntraRegion
NE_ADSL equipment	NLS2_1_ADSL_SDSL_Bitstream
NE_ethernet equipment	NLS2_1_LocalTail_PrivateVLAN_transport_lowEnd NLS2_1_LocalTail_Eline_LowEnd NLS2_1_LocalTail_PrivateVLAN_transport_HighEnd NLS2_1_LocalTail_Eline_HighEnd NLS2_1_Backbone_UnicastVLAN_Transport_IntraRegion
NE_NGA Active equipment	NLS2_1_VDSL_Bitstream
NE_NGA Housing	NLS2_1_VDSL_Bitstream
NE_PDH SDH equipment	NLS2_1_LocalTailCapacity_Ethernet>=10M NLS2_1_BackboneCapacity_Ethernet>=10M NLS2_0_IntraAreaBackboneCapacity<2M NLS2_0_IntraAreaBackboneCapacity=2M NLS2_0_IntraAreaBackboneCapacity>2M NLS2_0_IntrazonalBackboneCapacity<2M NLS2_0_IntrazonalBackboneCapacity=2M NLS2_0_LocalBackboneCapacity<2M NLS2_0_IntrazonalBackboneCapacity>2M NLS2_0_LocalBackboneCapacity>2M NLS2_0_LocalBackboneCapacity=2M NLS2_0_LocalTail=2M NLS2_0_LocalTail<2M NLS2_0_LocalTail>2M
NE_Copper_Cables_Distribution	NLS1_0_Copper_Subloop NLS1_0_Raw_Copper
NE_Copper_Cables_Feeding	NLS1_0_Copper_Subloop_testing NLS1_0_Raw_Copper
NE_Copper_Blocks_and_Tie_Cables	NLS1_0_Continue_Raw_Copper NLS1_0_Copper_Localloop_testing NLS1_0_Copper_Subloop_testing
NE_Copper_Splitter	NLS1_0_Copper_Splitter
NE_ATM equipment	NSF_ATM_Regional_Transport NSF_ATM_Tributary-Access

Layer n--layer n+1 cost allocation mechanism:

Each layer represented in the model produces the defined NLS services with a certain amount of volume (the service amount); this amount is “consumed” by the upper layer services and it is used as a driver to allocate the costs to the consumer services in the upper layers.

Layer cost allocation cascade:

The 5 defined layers are put one after another according to their level generating a cascade of cost allocation mechanism.

Each layer is discussed in a specific chapter of this documentation.

Establishing costs of the Network Stage Functions

The “network stage functions” (NSF) are the direct constituents of a layer, they are intermediate network building blocks providing well defined logical network functions specific to that layer (also called network functional units). A Network Stage Function can be limited to a node or it can be a cluster (distributed function) corresponding to “network stages”. A network stage function is characterized by the amount of function it produces (volume).

Network Stage Functions are implemented in equipment , but the corresponding investment values are not always directly identifiable in the asset structure of Belgacom : for example some assets aggregate investments per technology (not per function in the network) , some other do not cover the totality of a given technology due to the history of the accounting asset structure in SAP (reorganization of assets, transfers between assets, closing of asset classes and opening of new ones) .

Different methods are used and combined to constitute the investment costs of Network Stage Functions :

1. Aggregation of assets in a larger asset or a cost pool in order to gather investments of same technology and align them with operational inventories.
2. Deaggregation of cost pools in network elements : this step decomposes cost pools into network elements; a network element corresponds to an entire physical equipment as deployed in the Belgacom infrastructure. Operational inventories of pieces of equipment and component prices are used.
3. Direct allocation of assets or cost pools to network elements when the assets or cost pools are directly identifiable with a network element of the model.
4. Composition of the network elements to form a network stage function covering one of the stages.

The stepwise combination of these methods is discussed in the next section.

7.2 From Assets to Network Stage Functions.

Next table gives the list of the NSF present in the network allocation flow.

Layer_name	NSF_name	NSF description
L1_PASSIVE	NSF_Backbone_FibreConnectivity_express	backbone fibre connectivity of express ring
	NSF_Backbone_FibreConnectivity_Regional&Core	backbone fibre connectivity of regional&Core rings
	NSF_FTTC_FibreConnectivity	fibre connectivity between the central office (LEX) and ROP
	NSF_FTTO_FibreConnectivity	fibre connectivity between the central office (LEX) and customer office
L2_PACKETBASED	NSF_ATM_Regional_Transport	ATM regional backbone switching
	NSF_ATM_Tributary_Access	Tributary access to ATM backbone switched network

L3_IP	NSF_BroadBand_Public_IP_Collect	Access authentication , data traffic accounting, attribution of public IP address to broadband customers and collection of customer traffic towards public internet service providers
	NSF_BroadBand_VoD_IP_Collect	Access authentication , data traffic accounting, attribution of IP TV address to IP TV customers and collection of IP video customer traffic towards Video On Demand platforms
	NSF_BroadBand_VoIP_IP_Collect	Access authentication , data traffic accounting, attribution of Voice over IP address to VoIP customers and collection of Voice over IP customer traffic towards VoIP platforms
	NSF_Dedicated_Access_to_PrivateIP	connectivity between customer and Belgacom IP-VPN network
	NSF_Homegateway	Broadband CPE like b-box
	NSF_IP_security	
	NSF_PrivateIPSwitching	IP-VPN switching
	NSF_PublicInternetSwitching	Public Internet Routing
L4_IDTV	NSF_BroadcastTV	
	NSF_VoD	
L4_M2M	NSF_Machine_to_Machine	
L4_VOICE	NSF_Automated_call_distribution	intelligent distribution of calls towards call center
	NSF_CallerIdentity_CallHandling	Voice Value Added network function destined to residential customers
	NSF_InteractiveVoiceResponse_CallHandling	Voice Value Added network function
	NSF_InternetDialUp_CallHandling	
	NSF_ISDN_NetworkTermination	
	NSF_ISDN_Primary_Access	Access for PRA
	NSF_ISDN_Voice_concentrator	Aggregation of ISDN voice calls towards backbone circuit switching
	NSF_MessageWaitingIndicator_Inserting	Voice Value Added network function destined to residential customers
	NSF_Mobile_RAN	Mobile Radio Access function destined to all Mobile voice products
	NSF_Mobile_BackBone	Mobile back bone function destined to all Mobile voice and data products
	NSF_NumberPortability_CallHandling	telephony ported number realtime translation
	NSF_OtherAdvanced_CallHandling	Voice Value Added network function
	NSF_PairGainSystem	
	NSF_Payphones	
	NSF_PSTN_Voice_concentrator	Aggregation of PSTN voice calls towards backbone circuit switching
	NSF_Public_NumberPortability_Database	telephony ported number repository
	NSF_Service_Announcements_Playing	
	NSF_Televoting_CallHandling	Voice Value Added network function destined to Business customers
	NSF_VirtualPrivateNetwork_CallHandling	Voice Value Added network function destined to residential customers
	NSF_Voice_call_CAE_charging	generation of call detail records for interoperator voice traffic accounting
	NSF_Voice_call_CAE_Processing	handling of voice calls at transit level

	NSF_Voice_call_CAE_Trunks	multiplexing/demultiplexing voice circuits at transit level
	NSF_Voice_call_Local_charging	generation of call detail records for customer voice usage charging
	NSF_Voice_call_Local_Processing	handling of voice calls at originating or terminating level
	NSF_Voice_call_Local_Trunks	multiplexing/demultiplexing voice circuits generated/terminated
	NSF_VoiceFeatures_SelfManaging	Voice Value Added network function destined to residential customers
	NSF_Voicemail&Messaging	Voice Value Added network function destined to residential customers
	NSF_WakeUp_CallHandling	Voice Value Added network function destined to residential customers

Investment costs of Belgacom SA assets are mapped to these NSF, except investments related with network administration, and some other that cannot be related to any current product or service. The exceptions are not filed into the network allocation cascade, but are allocated like an overhead cost (i.e. with no direct causality) to a range of End User Services (depending on the kind of overhead cost) proportionally to the cascaded costs on these EUS.

Mapping asset cost sources to Asset objects of the model AC2

Network assets are 1-to-1 allocated to a homonymic AC2 object except for the 7 voice switching assets which are aggregated in AC2_Voice_Switching_Equipment.

Mapping AC2 objects to cost pools or Network elements

AC2 Aggregation.

At this stage AC2 asset objects are aggregated into cost pools, network elements, overhead objects and eventually end user services (costs marginal end user services, or direct waste).

The aggregations into cost pools serve to form technology pools for which operational inventories can be queried for various statistics that are further used to decompose into network elements. The technology pools typically are (D)WDM equipment, ATM equipment, Copper Cables, Broadband (ADSL/SDSL) equipment, SDH equipment, PDH equipment, Ethernet equipment etc. Those cost pools include also the OPEX of SDE.

The aggregation into network elements concerns assets that are already a network element, and it serves also to gather assets that are individually more detailed than the definition of network elements and that can be easily associated to a network element. Typical examples are IP-VPN assets, broadcast TV assets, Analog Multiplexers, Metallic line testing assets etc.

AC2 Deaggregation.

By contrast, a set of AC2 assets are decomposed (deaggregated) into cost pools, Network elements, waste pool and marginal end user services.

Among these, some assets collect investments on network administration (Hardware and software supervision platforms) and on value added services platforms (IN, messaging, voice mail etc.); they need to be decomposed into the network technologies they supervise and into the value added service categories.

- ⇒ The driver used is the “cumulatedInvestedAmount” per technology obtained after deep analysis of historical investment data (TM1 financial reporting tool).

The asset 1680 “TPT-BBN-infra.elect/mécan in transmis rooms” collects internal cabling within technical buildings and is decomposed essentially into the following cost pools CP_Backbone_Coax_cabling, CP_Backbone_Optical_cabling, CP_(D)WDM_equipment.

- ⇒ The driver used is the “Current annualized cost” of the cost pools , calculated from a diversity of constituent volumes and corresponding prices (coax/fibre cables, connectors, copper pair cables , cable ways,etc) . The main volumes are extracted from the infrastructure inventory database (ITR), other volumes are derived under assumptions.

The AC2_VoiceSwitching_Equipment asset is decomposed in the three main switching units forming the switched network topology : the Remote Units (acting principally as voice concentrators), the Base units (providing call processing and local switching), and the Transit Units (providing transit switching).

- ⇒ The driver used is the “Nbr of equivalent lines” , a unit that is at the basis of the purchase contracts with the switches vendors where purchased switching Unit (Remote, Base, Transit) value is proportional to the equivalent lines installed per switching unit. The driver value is obtained from installed base reporting of the switched voice network.

Deaggregation of cost pools into network elements

In performing the previous steps cost pools are introduced in the model. They are now deaggregated into different Network Elements by means of following drivers:

cost pool	driver name	Deaggregated Network Elements
CP_(D)WDM_equipment	yearly direct CAPEX cost	regional&core DWDM network elements and express DWDM network elements .
CP_Backbone_Coax_cabling	Nbr_Connections	pre-allocated to all inside network elements using coax cabling
CP_Backbone_Optical_cabling	Nbr_Connections	pre-allocated to all inside network elements using fibre cabling
CP_Copper_Burried_Cables&Splices	yearly direct CAPEX cost	distribution cables , feeding cables network
CP_DSLAM	yearly direct CAPEX cost	xDSL ATM based network elements and VDSL Ethernet based network elements
CP_Ducts&Manholes	Trenches cumulated length (km)	Ducts&Manholes for Next Generation Access, Ducts&Manholes for corporate/complex nodes in access
CP_EthernetMPLS_equipment	yearly direct CAPEX cost	Ethernet Ports, Ethernet/MPLS switches
CP_IntelligentNetwork_Hardware	EstimatedValue_of_IN_HW_components	Access fibre infrastructure elements, Backbone fibre infrastructure elements
CP_Optical_Fibre_Cables	km of fibre	Service Control Point hardware, Service ManagementPoint Hardware, CPU, RAM memory , Disk
CP_OSS_VoiceTraffic	fair split	Fibre cables for Next Generation Access, Fibre Cables for corporate/complex nodes in access
CP_SDH	yearly direct CAPEX cost	collecting, terminating and transit of voice network elements
CP_VoiceDigital_BaseUnit	%VendorCertifiedValue_of_RemoteUnit_subcomponents	Add/Drop Multiplexers at customer sites, Add/Drop Multiplexers in backbone, Special configurations in digital cross-connects
CP_VoiceDigital_RemoteUnit	%VendorCertifiedValue_of_RemoteUnit_subcomponents	Voice concentration elements, Originating/Terminating Voice call handling elements
CP_VoiceDigital_TransitUnit	%VendorCertifiedValue_of_RemoteUnit_subcomponents	Voice concentration elements, Voice call handling elements

From Network elements to Network Stage Functions

The previous steps populate the cost model with Network Elements. In the next step , they are allocated to the Network Stage Functions.

Among these, some network elements are directly embedded within Network Stage Function (either identical to a NSF or constituent of a NSF).

NE technology	#NE	NSF technology	#NSF
IDTV	4	IDTV	2
IP	4	IP	3
		WEB	1
MOBILE	7	MOBILE	3
VOICE	8	BVAS	1
		MVAS	3
		VOICE	4
ALL	1	ALL	1
ATMÐERNET	1	UNSPECIFIED	1
ETHERNET	1	IP	1
REALTIME DATA	1	REALTIME DATA	1

The other network elements need to be further decomposed either because they still aggregate a same function deployed in different network stages or because they still aggregate different functions delivering different volumes.

NE technology	#NE	NSF technology	#NSF
IP	1	IP	3
VOICE	5	BVAS	2
		MVAS	3
		VOICE	9
		VAS	1
ATM	1	ATM	2
FIBREPLANT	4	FIBRE	4
VAS	8	MOBILE	1
		MVAS	8
		VAS	1
VOIP	1	VOICE	2

The decomposition of network elements into network stage function is driven by a variety of cost drivers listed below per technology :

NE technology	Driver Name
FIBREPLANT	Estimated incremental trench length (km) kmxfibre Number of Optical Accesses (ROP/Offices)
IP	Total_tributary_capacity(Gbps)
VAS	fair split Invested_Amount perc_occupation_of_IN_hardw are_by_services
VOICE	Invested_Amount Nbr_of_equivalenceInstalledLines RoutedMin VendorCertifiedValue_of_Originating_Terminating_CallHandling_subcomponents VendorCertifiedValue_of_Transit_CallHandling_subcomponents
VOIP	VoIP_call_handling_distribution_local_Area

7.3 End User Services

The network allocation model terminates when all network stage functions (or NEs) have been allocated to network layer services and when network layer services have been combined into a user level telecommunication service, the End User Service.

The End User must be understood as the telecommunication service party that will pay for the service. In case of a retail service the user is identical to the service consumer (residential service) or to the service provider (business service), in case of wholesale service, the user is in principle another licensed operator, or a network service provider.

Being composed of network layer services, End User Services may emanate from different levels of network layers since interconnection between network operators is being unbundled. For retail services, the end user telecommunication services may arise from different layers: the more a service is oriented for a specific usage the higher the level of network layers involved. For example IP services are less usage oriented than voice telephony, the latter being a layer 4 service, the former a layer 3 service.

The End User Services represented in the model are listed hereunder.

End User Service Layer	Market	End User Service Name		
L1_PASSIVE	INTERCONNECT	EUS_Raw copper subscription EUS_Shared pair subscription		
	RETAIL&WHOLESALE	EUS_Broadband Drop		
L2_PACKETBASED	INTERCONNECT	EUS_BROBA_accessLine EUS_BROBA_EndUserLine subscription EUS_OLOAccessLine EUS_wholesale transport BROBA subscription EUS_wholesale transport WBA subscription		
	RETAIL	EUS_X25		
	WHOLESALE	EUS_Ethernet_Backhaul		
	INTERCONNECT	EUS_BROTSOLL_segment<2M EUS_BROTSOLL_segment>2M EUS_BROTSOLL_segment2M		
L2_TDM	RETAIL&WHOLESALE	EUS_LL <2M subscription - International EUS_LL <2M subscription - National EUS_LL >2M subscription- National EUS_LL >2M subscription - International EUS_LL 2M subscription - International EUS_LL 2M subscription - National EUS_LL Analog National Subscription - National		
	WHOLESALE	EUS_Nat IC-Infra Wholesale subscription		
	RETAIL&WHOLESALE	EUS_Trans LAN subscription		
	L3_IP	RETAIL	EUS_DataManagedServices EUS_Homegateway EUS_Mobile_Data national EUS_Public_IP_Extension_on_Symmetric	
		RETAIL&WHOLESALE	EUS_FastInternet subscription EUS_Private_IP&Ethernet_on_asymmetric subscription - National EUS_Private_IP&Ethernet_on_backup EUS_Private_IP&Ethernet_on_international Subscription EUS_Private_IP&Ethernet_on_symmetric_HighEnd Subscription - National EUS_Private_IP&Ethernet_on_symmetric_lowEnd Subscription - National	
		WHOLESALE	EUS_ADSL_Carrier_wholesale subscription EUS_Mobile_Roaming IN_Data EUS_VDSL_Carrier_wholesale subscription	
		RETAIL	EUS_IDTV_subscription	
		RETAIL	EUS_Machine_to_Machine	
		L4_MESSAGING	INTERCONNECT	EUS_BGC Mobile_Incoming SMS international EUS_BGC Mobile_Incoming SMS national
			RETAIL	EUS_Mobile_On net SMS EUS_Mobile_Outgoing SMS_international EUS_Mobile_Outgoing SMS_national
WHOLESALE			EUS_Mobile_Roaming IN_Originating_SMS EUS_Mobile_Roaming IN_Terminating_SMS	

L4_VOICE	INTERCONNECT	EUS_BGC Fixed international traffic incoming	
		EUS_BGC Fixed National Transit (M)OLO traffic EAA interconnection	
		EUS_BGC Fixed National Transit (M)OLO traffic IAA interconnection	
		EUS_BGC Fixed Outgoing International Freephone traffic	
		EUS_BGC Mobile international traffic incoming	
		EUS_BGC Mobile National outg. FOLO	
		EUS_Carrier PreSelection IAA interconnection	
		EUS_Carrier PreSelection local interconnection	
		EUS_Consultel 090x Traffic - BGC Fixed&Mobile to FOLO	
		EUS_EAA interconnection - (M)FOLO to BGC Fixed	
		EUS_Freephone Traffic - BGC fixed and Mobile to FOLO	
		EUS_IAA interconnection - BGC Fixed to FOLO	
		EUS_IAA interconnection - FOLO to BGC Fixed	
		EUS_IAA interconnection - MOLO to BGC Fixed	
		EUS_Incoming International Transit (M)OLO Traffic	
		EUS_Interconnection BGC Mobile to MOLO	
		EUS_Interconnection FOLO to BGC Mobile	
		EUS_Interconnection MOLO to BGC Mobile	
		EUS_International Transit border to border	
		EUS_international_switchingTrunk	
		EUS_internet traffic - FOLO to BGC 0909/3 IAA	
		EUS_Local interconnection - FOLO to BGC Fixed	
		EUS_Number Portability access per line subscription	
		EUS_Outgoing International Transit (M)OLO Traffic	
		EUS_Split Charging Traffic - BGC Fixed&Mobile to FOLO	
		EUS_Traff. Internet- BGC fixed	
		EUS_Voice_traffic_IAA_PointOfInterconnect subscription	
		EUS_Voice_traffic_Local_PointOfInterconnect subscription	
		RETAIL	EUS_Astrid
			EUS_BGC Mobile Outgoing to International Traffic
			EUS_BGC Mobile to BGC Fixed
			EUS_BGC Mobile to BGC Mobile
			EUS_BGC Mobile_Roaming Out Origination
			EUS_BGC Mobile_Roaming Out Termination
			EUS_BVAS Call & Conference - BGC fixed
			EUS_Consultel 090x Traffic - (M)FOLO to BGC Fixed
			EUS_Freephone Traffic - (M)FOLO to BGC
			EUS_ISDN CATT traffic - BGC Fixed
	EUS_MVAS - BGC Fixed		
	EUS_OPS International Information Traffic - BGC		
	EUS_OPS National Information Traffic - BGC		
	EUS_Other_Traffic - BGC Fixed		
	EUS_Payph operations - BGC Fixed		
	EUS_Split Charging Traffic - (M)FOLO to BGC Fixed		
	EUS_Universal Access Number Traffic - BGC Fixed&Mobile to FOLO		
	EUS_Virtual Private Network Traffic- BGC fixed		
RETAIL&WHOLESALE	EUS_BGC Fixed DCIA traffic		
	EUS_BGC Fixed international traffic outgoing		
	EUS_BGC Fixed interzonal traffic		
	EUS_BGC Fixed local traffic		
	EUS_BGC Fixed to BGC Mobile		
	EUS_BGC Fixed zonal non local traffic		
	EUS_Calling Card Postpaid Traffic - BGC Fixed		
	EUS_Consultel 090x Traffic - BGC Fixed&Mobile to BGC		
	EUS_EAA interconnection - BGC Fixed to FOLO		
	EUS_EAA interconnection - BGC Fixed to MOLO		
	EUS_Freephone Traffic - BGC Fixed&Mobile to BGC		
	EUS_IAA interconnection - BGC Fixed to MOLO		
	EUS_Incoming International Freephone Traffic (OLO+BGC mobile) to BGC		
	EUS_ISDN-BA Access - subscription		
	EUS_ISDN-PRA Access - subscription		
	EUS_PSTN Access - subscription		
	EUS_Split Charging Traffic - BGC Fixed&Mobile to BGC		
	EUS_Universal Access Number Traffic - BGC Fixed&Mobile to BGC		
WHOLESALE	EUS_Mobile_Roaming IN Termination		
	EUS_Universal Access Number Traffic - FOLO to BGC Fixed		
	EUS_Mobile_Roaming IN Origination		
L4_WEB	RETAIL	EUS_Eservices	

Broadband drop

The network element Broadband Drop groups costs related to fieldwork performed in the copper access network in order to realise broadband connections for end-users. These activities are mainly situated at the MDF, SC and the introduction up to the Network Termination Point (included).

7.4 Network services of the passive infrastructure layer : NLS1.0

7.4.1 Definition

This layer deals with the physical end-to-end connectivity between customers and the central sites (access), the physical connectivity inside the central site between access equipment and the physical connectivity between central sites (backbone).

Access Physical connectivity services (see Figure 20):

- NLS1_o_Continue_Raw_Copper : internal cabling for copper connectivity from Main Distribution Frame or broadband splitter equipment to other access active equipment like voice switches, leased lines access equipment, collocated access equipment (of other licensed operators).
- NLS1_o_Copper_Localloop_testing : inside copper connectivity and equipment required to perform remote testing of the copper loop.
- NLS1_o_Copper_Splitter : resources to split the narrowband and broadband copper physical signal.
- NLS1_o_Copper_Subloop : end-to-end copper connectivity from the network termination point at the customer premises to a delivery point in the street (street cabinet).
- NLS1_o_Copper_Subloop_testing : outside and inside copper connectivity and equipment required to perform remote testing of the copper subloop.
- NLS1_o_Raw_Copper : end-to-end copper connectivity from the network termination point at the customer premises to the Central site.
- NLS1_o_Fibre_connect_to_the_office : end-to-end fibre optical connectivity between the central sites and corporate customers office buildings .
- NLS1_o_Fibre_connect_to_the_OpticalNode: optical fiber connectivity between the central sites and the Belgacom subtended optical nodes.

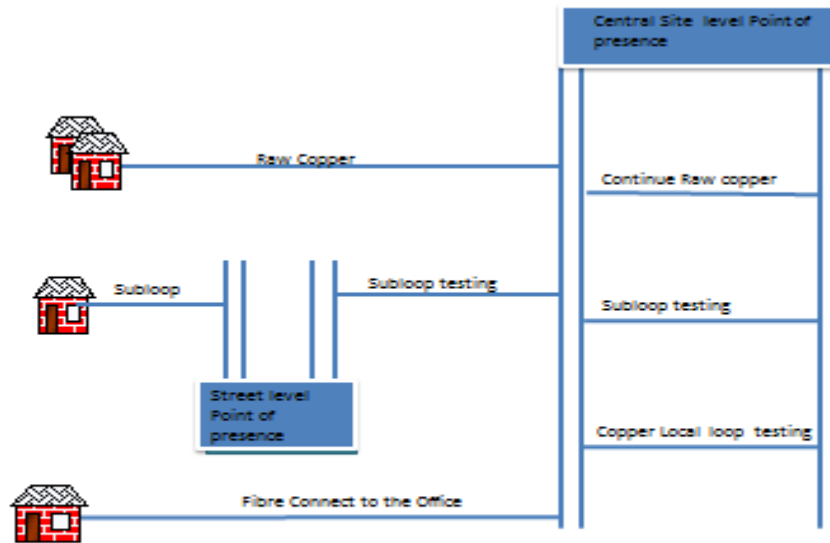

Figure 20: Access Physical connectivity services

Backbone Physical connectivity services

- NLS1_o_Fibre_connect_Backbone_SDH_Regional&Core: optical connectivity among the SDH equipments located at the regional and core Belgacom backbone nodes.
- NLS1_o_Fibre_connect_Backbone_DWDM_Regional&Core: optical connectivity supporting the DWDM network among the backbone regional and core nodes.
- NLS1_o_Fibre_connect_Backbone_DWDM_Express: optical connectivity for the DWDM network linking the express nodes.

7.4.2 Usage of the passive infrastructure

The physical connectivity services of this layer are used by upper layers in order to interconnect their specific equipment. The costs are distributed to the service users according to “consumption drivers” as listed in the table below.

Network layer Service	Driver	Service consumers
<u>NLS1_0_Continue_Raw_Copper</u>	Nbr_of_used_pairs	BRUO raw copper, Local tails for leased linetype of connectivity, ISDN/PSTN accesses, BRUO Shared Pairs
<u>NLS1_0_Copper_Localloop_testing</u>	nbr of lex based broadband connections without voice	Broadband bitstream layer 2.1 services
<u>NLS1_0_Copper_Splitter</u>	Direct	BRUO Shared pairs

<u>NLS1_0_Copper_Subloop</u>	Direct	VDSL bistream layer 2.1 service
<u>NLS1_0_Copper_Subloop_testing</u>	Direct	VDSL bistream layer 2.1 service
<u>NLS1_0_Raw_Copper</u>	Nbr_of_used_pairs	BRUO raw copper, Local tails for leased linetype of connectivity, ISDN/PSTN accesses, Broadband Bitstream layer 2.1 service
<u>NLS1_0_Fibre_connect_to_the_office</u>	Nb_access_fibres_used	Local tails services of layer 2.0 (for leased lines), of layer 2.1 (Ethernet local tails).
<u>NLS1_0_Fibre_connect_to_the_Optical Node</u>	Nb_access_fibres_used	Backbone services between the central office and the subtended optical nodes
<u>NLS1_0_Fibre_connect_Backbone_SDH_Regional&Core</u>	generic (CAPEX costs from PDH SDH MWE Technology)	Backbone services (leased lines/backhaul and Broadcast) delivered by the SDH equipment at regional and core level.
<u>NLS1_0_Fibre_connect_Backbone_DWDM_Regional&Core</u>	generic (CAPEX costs from NE_(D)WDM equipment)	Regional&Core backbone services of layer 2.1 (Ethernet transport, unicast and multicast)
<u>NLS1_0_Fibre_connect_Backbone_DWDM_Express</u>	generic (CAPEX costs from NE_Express_DWDM_equipment)	Express backbone services of layer 2.0 (leased lines) and layer 2.1 (Ethernet)

7.4.3 Contributors to the passive infrastructure layer

7.4.3.1 Access

The objective of the access network is the delivery of a connection between our customers and our telecommunication network where all services are implemented.

Copper infrastructure:

The access network services of the copper passive infrastructure layer are based on several network elements valued using the BIPT regulated cost price, as listed below. For these network elements, there is no change in the valuation methodology compared to previous model. As in the 2011 model, the former network element NE_Copper infrastructure has been split in several subparts, in order to enable the fix/variable analysis of the model results .

✓ NE_Copper_Cables_Distribution

copper distribution pairs and access to distribution pairs in street (to be attributed to copper subloop for VDSL connections without voice and to the raw copper for all other copper connections, based on the corresponding regulated cost);

✓ NE_Copper_Cables_Feeding

copper feeding pairs and access to feeding pairs in street and central site (to be attributed to the copper subloop testing for VDSL connections without voice and to the raw copper for all other connections);

- ✓ NE_Copper_Blocks_and_Tie_cables
 - copper local loop testing for broadband customer connections without voice at the central site,
 - copper subloop testing for ROP based VDSL customer connections without voice,
 - continue copper feeding pairs based on the number of shared pairs in service,
 - continue raw copper for all other copper pairs in use.
- ✓ NE_Copper Splitter
 - For the BRUO shared pairs in service

NSF_PSTN_Voice_concentrator:

Attributed to :

- copper local loop testing based on the number of broadband without voice customers connections at the central site,
- copper subloop testing for VDSL without voice customer connections at the street cabinet,
- PSTN Access based on the number of subscriptions.

Customer connections without voice are connected to the switching equipment in order to perform remote testing of the line.

FTTO:

NSF_FTTO_FibreConnectivity: contributing with the costs related to the high end accesses based on fiber technology and Belgacom subtended optical nodes.

7.4.3.2 Backbone

The backbone fibre connectivity services are realized by the following Network Stage Functions embodying the resources in the fibre outside plant (ducts&manholes, and fibre cables):

- NSF_Backbone_FibreConnectivity_Regional&Core
- NSF_Backbone_FibreConnectivity_express

NSF	Driver	NLS1_0
NSF_Backbone_FibreConnectivity_express	direct	NLS1_0_Fibre_connect_Backbone_DW DM_Express
NSF_Backbone_FibreConnectivity_Regional&Core	fair split of fixed cost	NLS1_0_Fibre_connect_Backbone_DW DM_Regional&Core NLS1_0_Fibre_connect_Backbone_SD H_Regional&Core

7.5 Network services of the transmission infrastructure (NLS2_o)

7.5.1 Definition

This layer deals with the transmission services between customer sites and the Belgacom Offices (access) also called local tail for leased lines, and it deals also with the transport segments services (also called backbone leased lines segments and backhaul capacity) between Belgacom Offices (backbone).

The national wide transmission infrastructure collects transmission traffic in three aggregation stages: local level aggregation (circ 600 locations), zonal level aggregation (circ 36 locations), area level aggregation (20 locations) (see Figure 21: Transport Segments). Traffic at each stage can be crossconnected allowing to create transport segments from any location to any location.

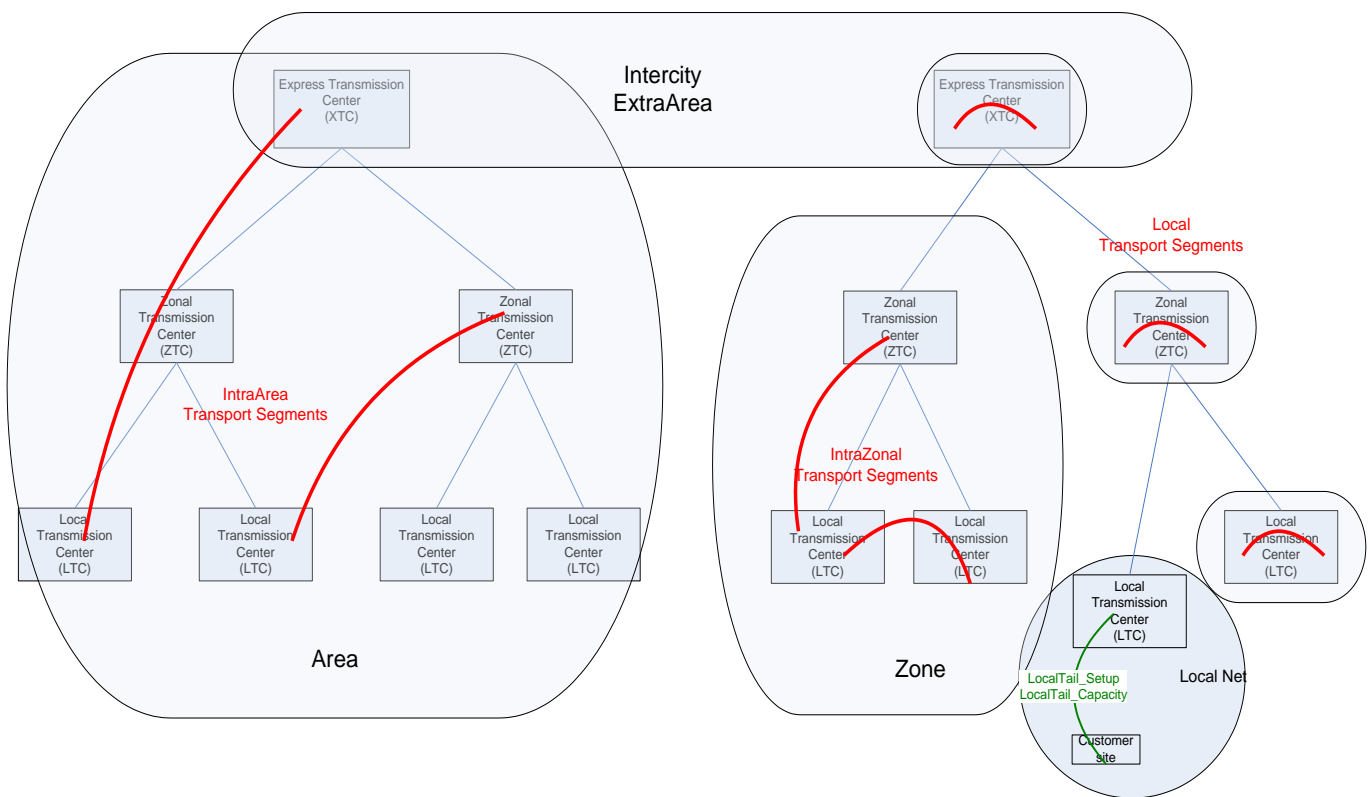

Figure 21: Transport Segments

Access services

The access services deliver the transmission between the customer site and the Belgacom Office (access).

They capture costs related to the physical_dedicated link between the customer site and the central office and the equipment needed to activate the link in a capacity category.

Backbone services:

The backbone transport segments are classified in capacity (or bandwidth) categories -<2Mb/s, 2Mb/s, >2Mb/s- combined with distance categories -intraarea > intrazonal > local- depending on the end point situation in the aggregation hierarchy (see Figure 21).

The following NLS2.0 services are present in the model:

Network Layer 2.0 service
NLS2_0_LocalBackboneCapacity<2M
NLS2_0_LocalBackboneCapacity=2M
NLS2_0_LocalBackboneCapacity>2M
NLS2_0_IntrazonalBackboneCapacity<2M
NLS2_0_IntrazonalBackboneCapacity=2M
NLS2_0_IntrazonalBackboneCapacity>2M
NLS2_0_IntraAreaBackboneCapacity<2M
NLS2_0_IntraAreaBackboneCapacity=2M
NLS2_0_IntraAreaBackboneCapacity>2M
NLS2_0_InterCityBackboneCapacity<2M
NLS2_0_InterCityBackboneCapacity=2M
NLS2_0_InterCityBackboneCapacity>2M
NLS2_0_LocalTail<2M
NLS2_0_LocalTail=2M
NLS2_0_LocalTail>2M

7.5.2 Usage of the transmission infrastructure

The NLS2_o Local tail services are used to bring transmission capacity to the customer sites and they are thus directly involved in leased line services between two customer sites, leased lines to data services, backhaul services to other licensed operators and monitoring of the access network.

The costs of these access services are distributed according to the number of customer sites per bandwidth category (driver name: “Nbr_of_Customer_sites”), whereas the backbone services costs are further allocated according to their bandwidth (driver name: “Bandwidth consumed (Mbit/s)”).

The model elements receiving costs from this network layer are exhaustively presented in the following table.

	Upper layer consumer or end user service
Backbone Virtual Paths (VP)	NLS2_1_Backbone_VirtualPath_InterArea
	NLS2_1_Backbone_VirtualPath_IntraArea
Belgacom mobile	NLS4_0_Abis
	NLS4_0_BGC Mobile_Access_Collect
	NLS4_0_BGC Mobile_BackBone
	NLS4_0_BGC MobileSwitchedVoice_transport_National_offnet
	NLS4_0_IuB
	NLS4_0_MobileTerminatingLinks

Belgacom testing environments	OVH_Lab
Broadband access to public IP switching	NLS3_ADSL_Public_IP_collection
	NLS3_VDSL_Public_IP_collection
Data services backbone (IP-VPN)	NLS3_Private_IP&Ethernet_Routing
Internal Belgacom network	OVH_InternalCommunicationNetwork
	OVH_InternallIPNetwork
International access to data services (IP-VPN)	EUS_Private_IP&Ethernet_on_international Subscription
Leased line access to public IP switching	NLS3_Public_IP_Extension_on_symmetric
Leased line accesses to data services (IP-VPN)	NLS3_Private_IP&Ethernet_Extension_on_symmetric_HighEnd
	NLS3_Private_IP&Ethernet_Extension_on_symmetric_LowEnd
Other	Business Overhead
	EUS_DataManagedServices
	EUS_Subsiaries
	NLS4_0_VAS_signaling
	NLS4_1_BVAS - BGC Fixed
Public IP switching	NLS3_Public_IP_switching
Regulated broadband services	EUS_BROBA_accessLine
	NLS2_1_ADSL_SDSL_Bitstream
Regulated wholesale segments	EUS_BROTSOLL_segment<2M
	EUS_BROTSOLL_segment>2M
	EUS_BROTSOLL_segment2M
Retail&Wholesale leased lines	EUS_international_switchingTrunk
	EUS_LL <2M subscription - International
	EUS_LL <2M subscription - National
	EUS_LL >2M subscription- National
	EUS_LL >2M subscription - International
	EUS_LL 2M subscription - International
	EUS_LL 2M subscription - National
	EUS_LL Analog National Subscription - National
	EUS_X25
Telephony access	NLS4_0_ISDN-PRA_access
	NLS4_0_PSTN_access
TV services	NLS4_0_BroadcastTV
	NLS4_0_iDTV
Voice services in backbone	NLS4_0_FixedSwitchedVoice_transport_National_offnet
	NLS4_0_RemotelyAggregatedVoice_transport
	NLS4_0_SwitchedVoice_transport_CAE_CAE
	NLS4_0_SwitchedVoice_transport_CAE_MSC
	NLS4_0_SwitchedVoice_transport_LEX_CAE
	NLS4_0_SwitchedVoice_transport_LEX_MSC
Wholesale transport capacity	EUS_Bandwidth_Wholesale subscription
	EUS_Nat IC-Infra Wholesale subscription

7.5.3 Contributors to the transmission infrastructure

7.5.3.1 Local Tail

A local tail transmission service is made of equipment installed at the customer premises extracting the digital signal from the physical line, of a physical link between the customer site and the central office and of grooming equipment in the central office (or subtended optical nodes).

Depending on the bandwidth of the local tail different equipment technologies are installed: PDH on copper, PDH on fibre or SDH on fibre. For the high bandwidth cases (>2Mb/s) a fibre based technology is required whereas for lower bandwidths the choice between fibre and copper technologies exists. However, since fibre local links are much more expensive than copper links, the preferred option for low bandwidth local tails is the copper based solution.

	Contributor to NLS2_0	Driver name
Equipment	NE_PDH SDH equipment	yearly incremental cost
Physical links	NLS1_0_Raw_Copper	Nbr_of_used_pairs
	NLS1_0_Continue_Raw_Copper	Nbr_of_used_pairs
	NLS1_0_Fibre_connect_to_the_office	Nb_access_fibres_used

7.5.3.2 Transport Segments

Transport segments are realised by configuring the SDH clusters in different network stages. The transmission aggregation levels introduced hereabove (section 7.5.1 and Figure 21) are realised by different SDH clusters (regional, core and express SDH rings) interconnected by digital-crossconnects. The SDH rings are made of add-drop multiplexers deployed in LTC for the regional ones, in ZTC for the core ones and in the XTC for the express ones. The equipments within a ring are linked by fibre or by an optical wavelength.

To summarize, the building blocks for the transport segments are:

Contributor to NLS2_0	Driver name
NLS1_0_Fibre_connect_Backbone_DWDM_Express	generic (CAPEX costs from NE_Express_DWDM_equipment)
NLS1_0_Fibre_connect_Backbone_SDH_Regional&Core	generic (CAPEX costs from PDH SDH MWE Technology)
NE_Express_DWDM_equipment	bandwidth(Mbps)
NE_PDH SDH equipment	yearly direct CAPEX cost
NE_Express_SDH_equipment	bandwidth(Mbps)

7.6 Network services of the packet based infrastructure (NLS2_1)

7.6.1 Definition

This layer deals with the data collection services (broadband or dedicated) between the customer and the central office (access) and the transport of data central office (backbone). Two technologies coexist as well in the access part as in the backbone part: ATM technology and Ethernet/MPLS technology. Next picture summarizes the end point locations of packet based services.

This layer also integrates point to point dedicated Ethernet transparent connections also named BLES services (Belgacom LAN Extension Service).

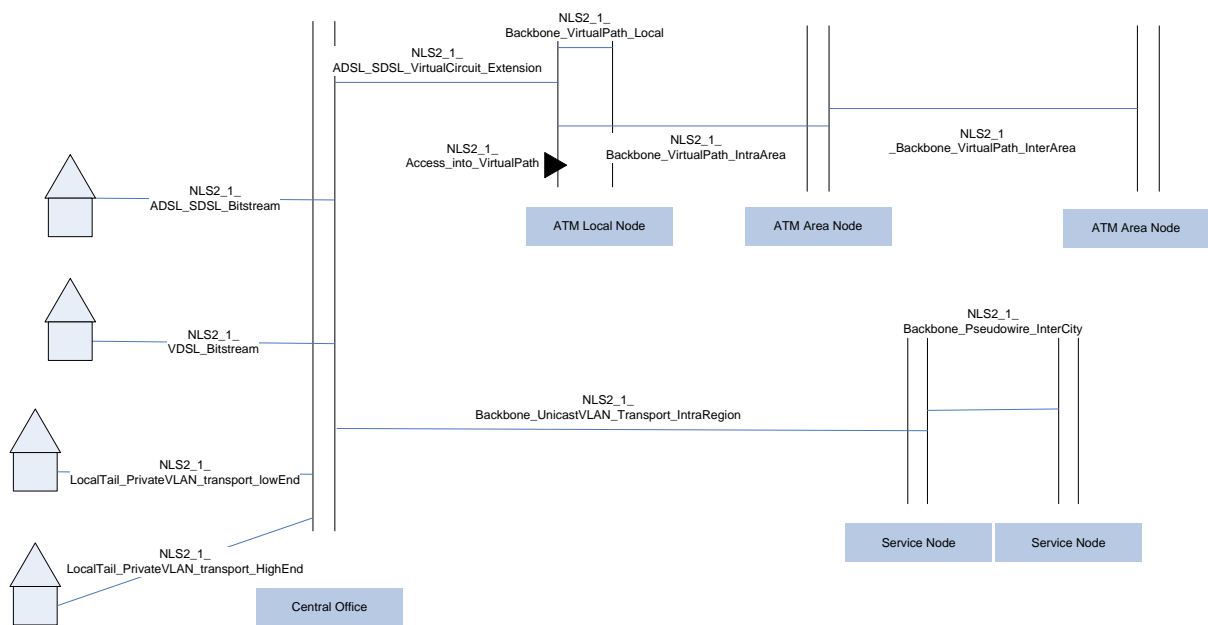

Figure 22: Network services of the packet based infrastructure 2.1

Access part

Layer 2.1 access service	Comment
NLS2_1_ADSL_SDSL_Bitstream	Broadband (ADSL-SDSL) end to end data streams between customer site and aggregation point in central office
NLS2_1_VDSL_Bitstream	Broadband VDSL end to end data streams between customer site and aggregation point in central office
NLS2_1_LocalTail_PrivateVLAN_transport_lowEnd	Ethernet symmetric dedicated link with central office over copper
NLS2_1_LocalTail_PrivateVLAN_transport_highEnd	Ethernet symmetric dedicated link with central office over fibre
NLS2_1_LocalTailCapacity_Ethernet>=10M	High bandwidth transparent Ethernet frame transport between customer and central office (BLES local tail)
NLS2_1_LocalTail_Eline_HighEnd	Ethernet symmetric dedicated link with central office

Backbone part

For data transport between central offices, the end point locations of the layer 2.1 services depend on the technology, the underlying networks having different topologies.

For ATM technology , the following services are defined:

Layer 2.1 ATM transport service	Comment
NLS2_1_Backbone_VirtualPath_Local	Transport of virtual circuits in a same ATM path in ATM local point of presence
NLS2_1_Backbone_VirtualPath_IntraArea	Transport of virtual circuits in a same ATM path from an ATM local point of presence up to the area level point of presence
NLS2_1_Backbone_VirtualPath_InterArea	Transport of virtual circuits in a same ATM path between 2 ATM area level point of presence.
NLS2_1_Access_into_VirtualPath	Direct access to a virtual path , allows to inject/eject ATM virtual circuits in/out of a transport virtual path

For the Ethernet/MPLS technology , the following services are defined:

Layer 2.1 Ethernet transport service	Comment
NLS2_1_Backbone_UnicastVLAN_Transport_IntraRegion	MPLS Transport of Ethernet VLANs between a central office and the service node of the region. These VLANs are unicast
NLS2_1_Backbone_Pseudowire_InterCity	MPLS Transport of Ethernet VLANs between service nodes of different regions. These VLANs are unicast
NLS2_1_Backbone_MulticastVPLS_IntraRegion	

Eventually , the dedicated Ethernet transparent connections (BLES service) also introduce backbone connectivity services :

Layer 2.1 Ethernet transparent transport	Comment
NLS2_1_BackboneCapacity_Ethernet>=10M	Any combination of end points different that of the two of them being express transmission centers
NLS2_1_InterCityBackboneCapacity_Ethernet>=10M	End points are between two express transmission centers

7.6.2 Usage of the data packet infrastructure

The access services of the data packet infrastructure are combined with the data packet backbone services to deliver end-to-end connectivity between IP appliances at customer site (IP router in ADSL/VDSL modems, private LAN IP routers) and IP service nodes , primarily the broadband access servers and the IPVPN routers offering layer3 services like ADSL/SDSL IP collection, VoD IP collection, Private VLAN extensions up to IPVPN nodes.

Next table summarizes the drivers used expressing how NLS2.1 contribute in layer 3 services or directly to End user services.

NLS2.1 service	Driver Name	Upper layer services "consuming" NLS2.1 services
NLS2_1_ADSL_SDSL_Bitstream	Nbr_of_used_xDSL_BROBA_lines	BROBA end user line, all broadband IP collections (public internet, VoD, VoIP), and broadband access to IP VPN
NLS2_1_VDSL_Bitstream	Nbr_of_used_VDSL_lines	all broadband IP collections (public internet, VoD, VoIP), and broadband access to IP VPN
NLS2_1_Access_into_VirtualPath	Configured_Bandwidth(Gbps)	Symmetric accesses to IPVPN and BROBA access line
NLS2_1_Backbone_MulticastVPLS_IntraRegion	direct	For television
NLS2_1_Backbone_Pseudowire_InterCity	TotalPeakBandwidth_used(Gbps)	Broadband public IP NLS3 service, VoIP , Broadcast TV, and private IPVPN routing
NLS2_1_Backbone_UnicastVLAN_Transport_IntraRegion	EthanePeakHourPeakBandwidth_used(Mbps)	Broadband public IP NLS3 service, VoIP , VoD and access to private IPVPN routing, Ethernet backhaul and WBA transport
NLS2_1_Backbone_VirtualPath_InterArea	VP bandwidth Gbps	BROBA transport, Broadband public IP NLS3 service, VoIP , VoD and access to private IPVPN routing
NLS2_1_Backbone_VirtualPath_InterArea	VP equivalent bandwidth Gbps (Topological efficiency and QoS aspects are translated in bandwidth +or- committed bandwidth)	
NLS2_1_Backbone_VirtualPath_Local	VP equivalent bandwidth Gbps (Topological efficiency and QoS aspects are translated in bandwidth +or- committed bandwidth)	
NLS2_1_InterCityBackboneCapacity_Ethernet>=10M	Bandwidth consumed (Mbit/s)	BLES EUS services, High capacity accesses to IPVPN, IP-VPN routers interconnection, internal networks routers interconnection
NLS2_1_BackboneCapacity_Ethernet>=10M	Bandwidth consumed (Mbit/s)	
NLS2_1_LocalTailCapacity_Ethernet>=10M	Bandwidth consumed (Mbit/s)	
NLS2_1_LocalTail_PrivateVLAN_Transport_HighEnd	direct	Access to IPVPN layer 3 services
NLS2_1_LocalTail_PrivateVLAN_Transport_LowEnd	direct	Access to IPVPN layer 3 services

7.6.3 Contributors to the data packet infrastructure services

The ATM based layer2.1 services are implemented by the configuration of the ATM network elements interacting with each other using lower layer connectivity services (see picture Figure 23: ATM based layer 2.1).

NLS2_1 ADSL SDSL Bitstream is the result of the central office (the Belgacom technical building closest to the end customer) based network element NE_ADSL equipment. That function interacts with the broadband CPE equipment (at the customer site) by means of copper connectivity and potentially fiber connectivity to optical subtended nodes.

NLS2_1 Backbone VirtualPath IntraArea is the result of network element NE_ATM equipment function to inject the collected traffic into ATM VP , followed by the regional transport function implemented in the ATM switching units and ATM backbone interfaces.

The switching units interact with each other using lower level layer connectivity services (NLS2_o_XXXBackboneCapacityX2M).

NLS2_1 Backbone VirtualPath Local is the result of network element NE_ATM equipment function to inject the collected traffic into ATM VP , followed by the regional transport function implemented in the ATM switching units (no backbone interface as VP remains local in the ATM equipment).

The Ethernet based layer 2.1 services are implemented by the configuration of the Ethernet/MPLS network elements (NE_ethernet equipment) interacting with each other using lower layer connectivity services (see picture Figure 24).

NLS2_1 VDSL Bitstream is the result of the function present in the deployed VDSL equipment (network elements NE_NGA Active equipment and NE_NGA Housing).

That function interacts with the broadband CPE equipment (at the customer site) by means of copper and fibre connectivity.

NLS2_1 Backbone UnicastVLAN Transport IntraRegion is the result of the Ethernet/MPLS unicast function present in the deployed Ethernet equipment (NE_ethernet equipment). The function is activated in different locations to form aggregation clusters, whose links are mainly deployed on DWDM (NE_(D)WDM equipment) and in a limited number by direct fibre connectivity. The NLS2_1 Backbone Pseudowire InterCity and the NLS2_1 Backbone MulticastVPLS IntraRegion are implemented in the exact same way.

NLS2_1 LocalTail PrivateVLAN transport HighEnd or LowEnd and NLS2_1 LocalTail Eline HighEnd are the result of customer sited equipment (NE_ethernet equipment) and the connectivity to the Belgacom network. Such connectivity consists of a fibre based link for the high end cases and of a copper based link in the low end situation.

Finally the dedicated Ethernet transparent connection services NLS2_1_LocalTailCapacity_Ethernet \geq 10M, NLS2_1_XXX_BackboneCapacity_Ethernet \geq 10M are realized either on SDH equipment (up to 100 Mbps), reusing the SDH clusters deployed and already discussed in 7.5.3 (SDH over fibre) or for very high capacity connections (above 100 Mbps) they are directly realized on a wavelength (deployed as Fibre_connect_to_the_office for the local tail and as (D)WDM for the other cases).

The table hereunder summarizes the drivers used to distribute the cost contributors to the NLS2.1 services.

NLS2_1 service category	Building block of layer 2_1 service	Driver name
Access_into_VirtualPath	NSF_ATM_Tributary_Access	Configured bandwidth (Gbps)
ATM & Ethernet transport	NE_(D)WDM equipment	yearly direct CAPEX cost
	NSF_ATM_Regional_transport	Equivalent switched amount (Gbps)
	NE_ethernet equipment	yearly direct CAPEX cost
	NE_Express_DWDM_equipment	bandwidth(Mbps)
	NE_Express_Ethernet_equipment	direct
	NE_Express_SDH_equipment	bandwidth(Mbps)
	NLS1_0_Fibre_connect_Backbone_DWDM_Express	generic (CAPEX costs from NE_Express_DWDM_equipment)
	NLS1_0_Fibre_connect_Backbone_DWDM_Regional&Core	generic (CAPEX costs from NE_(D)WDM equipment)
	NLS2_0_InterCityBackboneCapacity>2M	Bandwidth consumed (Mbit/s)
	NLS2_0_IntraAreaBackboneCapacity>2M	Bandwidth consumed (Mbit/s)
Backbone_MulticastVPLS_IntraRegion	NE_(D)WDM equipment	yearly direct CAPEX cost
	NLS1_0_Fibre_connect_Backbone_DWDM_Regional&Core	generic (CAPEX costs from NE_(D)WDM equipment)
Broadband aggregation	NE_ADSL equipment	direct
	NE_NGA Active equipment	direct
	NE_NGA Housing	direct
	NLS1_0_Copper_Localloop_testing	nbr of broadband lex based without voice
	NLS1_0_Copper_Subloop	direct
	NLS1_0_Copper_Subloop_testing	Nbr_of_used_pairs
	NLS1_0_Fibre_connect_to_the_OpticalNode	Nb_access_fibres_used
	NLS1_0_Raw_Copper	Nbr_of_used_pairs
	NLS2_0_InterCityBackboneCapacity>2M	Bandwidth consumed (Mbit/s)
	NLS2_0_IntraAreaBackboneCapacity>2M	Bandwidth consumed (Mbit/s)
Ethernet local tail	NE_ethernet equipment	yearly direct CAPEX cost
	NLS1_0 Continue_Raw_Copper	Nbr_of_used_pairs
	NLS1_0_Fibre_connect_to_the_office	Nb_access_fibres_used
	NLS1_0_Raw_Copper	Nbr_of_used_pairs
Transparent Ethernet connection services	NE_(D)WDM equipment	yearly direct CAPEX cost
	NE_Express_DWDM_equipment	bandwidth(Mbps)
	NE_Express_SDH_equipment	bandwidth(Mbps)
	NE_PDH SDH equipment	yearly direct CAPEX cost
	NLS1_0_Fibre_connect_Backbone_DWDM_Express	generic (CAPEX costs from NE_Express_DWDM_equipment)
	NLS1_0_Fibre_connect_Backbone_DWDM_Regional&Core	generic (CAPEX costs from NE_(D)WDM equipment)
	NLS1_0_Fibre_connect_Backbone_SDH_Regional&Core	generic (CAPEX costs from NE_PDH SDH equipment)
NLS1_0_Fibre_connect_to_the_office	Nb_access_fibres_used	

7.7 Network services of the IP infrastructure layer (NLS3-IP)

7.7.1 Scope

This layer provides the following basic IP services in the model.

IP service type	IP service
Collection of IP traffic for public internet or internal internet	NLS3_ADSL_Public_IP_collection
	NLS3_SDSL_Public_IP_collection
	NLS3_VDSL_Public_IP_collection
	NLS3_VoD_IP_collection
	NLS3_VoIP_IP_collection
	NLS3_Public_IP_Extension_on_symmetric
Public Internet routing	NLS3_Public_IP_switching
Connection of IP sites to IP-VPN	NLS3_Private_IP&Ethernet_Extension_on_symmetric_HighEnd
	NLS3_Private_IP&Ethernet_Extension_on_symmetric_LowEnd
	NLS3_Private_IP&Ethernet_Routing
	NLS3_Private_IP&Ethernet_Extension_on_asymmetric
	NLS3_Private_IP&Ethernet_Extension_on_symmetric_Datacenter
IP security	NLS3_IP_security

The actual NLS3's are described next. A comprehensive listing of which NLS or EUS they contribute to together with a description of the driver utilized in each case is also presented. Finally, a table will exhibit the cost allocation of these layer services, including driver and driver volume.

7.7.1.1 Public services

7.7.1.1.1 IP_collection

Gathers all the data traffic, except that of the private networks, generated by the customers at their locations -homes and offices placed all over the country- at the highest network level where it can be further delivered to the Internet.

This gathering is achieved thanks to the broad and narrow band servers together with the connectivity capabilities of the ATM and MPLS backbone networks.

This generic service is in fact divided in several actual NLS3, depending on the traffic type and/or underlying technology, as follows:

- Data traffic:
 - NLS3_ADSL_Public_IP_Collection
 - NLS3_SDSL_Public_IP_Collection
 - NLS3_VDSL_Public_IP_Collection

- NLS3_Public_IP_Extension_on_symmetric: where the customer-IP router connectivity is provided by means of Leased Lines, as opposed to the other services which are based on broadband access technologies.
- Video on Demand traffic:
 - NLS3_VoD_IP_Collection
- Voice over IP traffic:
 - NLS3_VoIP_IP_Collection

Further, these NLS3's contribute to the following higher network layer services and end user services (EUS) as specified hereunder:

NLS3	Driver name	Target element
NLS3_ADSL_Public_IP_collection	Nbr_of_retail_wholesale_ADSL_lines	EUS_ADSL_Carrier_wholesale subscription
NLS3_ADSL_Public_IP_collection	Nbr_of_retail_wholesale_ADSL_lines	EUS_FastInternet subscription
NLS3_SDSL_Public_IP_collection	Nbr_of_retail_wholesale_SDSL_lines	EUS_FastInternet subscription
NLS3_VDSL_Public_IP_collection	Nbr_of_retail_wholesale_VDSL_lines	EUS_VDSL_Carrier_wholesale subscription
NLS3_VDSL_Public_IP_collection	Nbr_of_retail_wholesale_VDSL_lines	EUS_FastInternet subscription
NLS3_Public_IP_Extension_on_symmetric	direct	EUS_Public_IP_Extension_on_Symmetric
NLS3_VoD_IP_collection	direct	NLS4_0_VoD
NLS3_VoIP_IP_collection	direct	NLS4_0_PSTN_access

7.7.1.1.2 Public_IP_switching

This service brings the intelligence to route the gathered traffic by the “IP_collection” generic NLS3 into the appropriate external network within the “public Internet”.

This service, NLS3_Public_IP_switching, is fully and exclusively realized by the Belgacom Internet Routers and is totally dedicated to the end user service EUS_FastInternet subscription.

7.7.1.2 Private services

7.7.1.2.1 Private_IP&Ethernet_Extension

This NLS transparently extends the customer's private local area networks, situated at any location within Belgium, to the edge of the Belgacom's network, thanks to the routers installed at the customer premises (CPE) and the connectivity capabilities of the ATM and MPLS aggregation and core- clouds.

This generic service consists in fact of several actual services, specific to the access technology type, as follows:

- NLS3_Private_IP&Ethernet_Extension_on_symmetric_Datacenter
- NLS3_Private_IP&Ethernet_Extension_on_asymmetric
- NLS3_Private_IP&Ethernet_Extension_on_symmetric_lowEnd
- NLS3_Private_IP&Ethernet_Extension_on_symmetric_highEnd

The higher level NLS/EUS to which the above NLS3's deliver their services and their costs allocations are:

NLS3	Driver name	Target element
NLS3_Private_IP&Ethernet_Extension_on_asymmetric	Nbr_sites_ADSL_VDSL	EUS_Private_IP&Ethernet_on_backup
NLS3_Private_IP&Ethernet_Extension_on_asymmetric	Nbr_sites_ADSL_VDSL	EUS_Private_IP&Ethernet_on_asymmetric subscription – National
NLS3_Private_IP&Ethernet_Extension_on_symmetric_Datacenter	direct	EUS_DataManagedServices
NLS3_Private_IP&Ethernet_Extension_on_symmetric_HighEnd	Nbr_sites_EAL_LL	EUS_Private_IP&Ethernet_on_backup
NLS3_Private_IP&Ethernet_Extension_on_symmetric_HighEnd	Nbr_sites_EAL_LL	EUS_Private_IP&Ethernet_on_symmetric_HighEnd Subscription – National
NLS3_Private_IP&Ethernet_Extension_on_symmetric_LowEnd	Nbr_sites_SDSL_EFM	EUS_Private_IP&Ethernet_on_backup
NLS3_Private_IP&Ethernet_Extension_on_symmetric_LowEnd	Nbr_sites_SDSL_EFM	EUS_Private_IP&Ethernet_on_symmetric_lowEnd Subscription – National

7.7.1.2.2 NLS3_Private_IP&Ethernet_Routing

This NLS delivers the capability of routing the private networks traffic to the requested end point, within the Belgacom private IPVPN network.

This service, NLS3_Private_IP&Ethernet_Routing, is completed by the Belgacom IPVPN Routers and the core MPLS cloud and, in turn, supports all the following EUS:

NLS3	Driver name	Target element
NLS3_Private_IP&Ethernet_Routing	TotalPeakBandwidth_used(Gbps)	EUS_Private_IP&Ethernet_on_asymmetric subscription - National
NLS3_Private_IP&Ethernet_Routing	TotalPeakBandwidth_used(Gbps)	EUS_Private_IP&Ethernet_on_symmetric_HighEnd Subscription - National
NLS3_Private_IP&Ethernet_Routing	TotalPeakBandwidth_used(Gbps)	EUS_Private_IP&Ethernet_on_international Subscription
NLS3_Private_IP&Ethernet_Routing	TotalPeakBandwidth_used(Gbps)	EUS_DataManagedServices
NLS3_Private_IP&Ethernet_Routing	TotalPeakBandwidth_used(Gbps)	EUS_Private_IP&Ethernet_on_symmetric_lowEnd Subscription - National

Figure 25: Layer 3 topology and contributors exhibits the layer's basic topology and all the contributors to the Layer 3 services.

NLS3 - IP

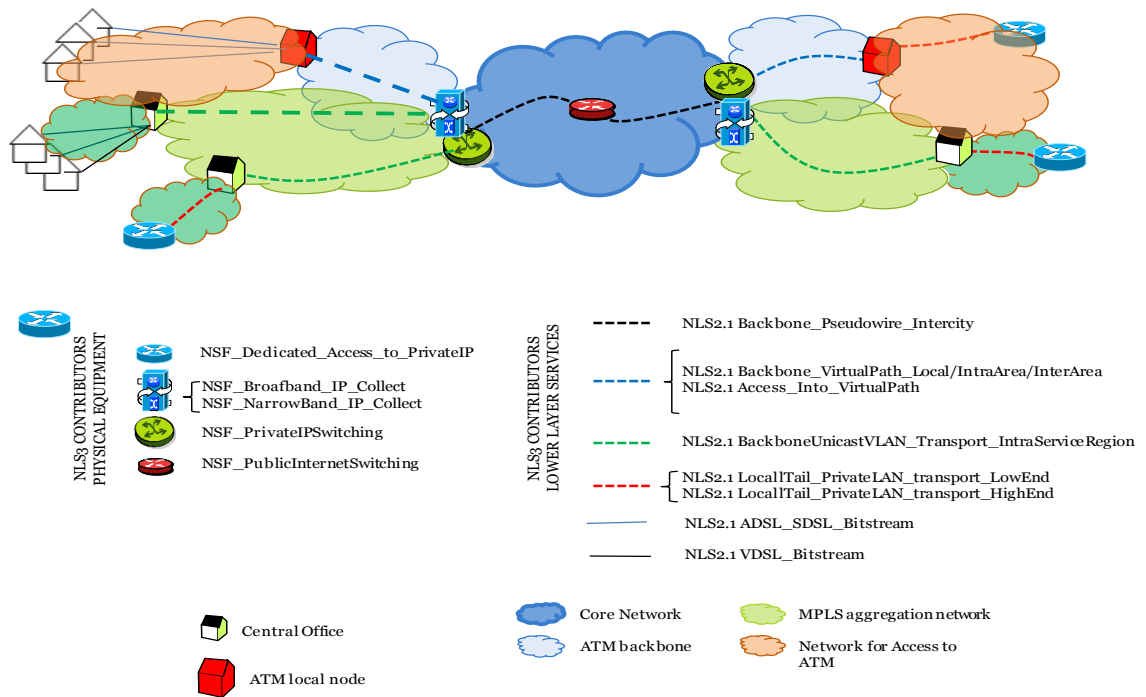

Figure 25: Layer 3 topology and contributors

7.7.2 Contributors to the Network Layer 3 services

The table hereunder summarizes the contributors and the drivers used to distribute the costs to the NLS3 services.

NLS3 service category	Building block of layer 3 service	Driver name
Asymmetric Private_IP&Ethernet_Extension	NLS2_1_ADSL_SDSL_Bitstream	Nbr_of_used_xDSL_BROBA_lines
	NLS2_1_Backbone_UnicastVLAN_Transport_IntraRegion	EthanePeakHour PeakBandwidth_used(Mbps)
	NLS2_1_Backbone_VirtualPath_InterArea	VP bandwidth Gbps
	NLS2_1_Backbone_VirtualPath_IntraArea	VP equivalent bandwidth Gbps (Topological efficiency and QoS aspects are translated in bandwidth +or-committed bandwidth)
	NLS2_1_Backbone_VirtualPath_Local	VP equivalent bandwidth Gbps (Topological efficiency and QoS aspects are translated in bandwidth +or-committed bandwidth)

	NLS2_1_VDSL_Bitstream	Nbr_of_used_VDSL_lines
	NSF_Dedicated_Access_to_PrivatelP	Nbr_of_Sites
Symmetric Private_IP&Ethernet_Extension	NLS2_0_InterCityBackboneCapacity<2M	Bandwidth consumed (Mbit/s)
	NLS2_0_InterCityBackboneCapacity=2M	Bandwidth consumed (Mbit/s)
	NLS2_0_InterCityBackboneCapacity>2M	Bandwidth consumed (Mbit/s)
	NLS2_0_IntraAreaBackboneCapacity<2M	Bandwidth consumed (Mbit/s)
	NLS2_0_IntraAreaBackboneCapacity=2M	Bandwidth consumed (Mbit/s)
	NLS2_0_IntraAreaBackboneCapacity>2M	Bandwidth consumed (Mbit/s)
	NLS2_0_IntrazonalBackboneCapacity<2M	Bandwidth consumed (Mbit/s)
	NLS2_0_IntrazonalBackboneCapacity=2M	Bandwidth consumed (Mbit/s)
	NLS2_0_IntrazonalBackboneCapacity>2M	Bandwidth consumed (Mbit/s)
	NLS2_0_LocalBackboneCapacity<2M	Bandwidth consumed (Mbit/s)
	NLS2_0_LocalBackboneCapacity=2M	Bandwidth consumed (Mbit/s)
	NLS2_0_LocalBackboneCapacity>2M	Bandwidth consumed (Mbit/s)
	NLS2_0_LocalTail<2M	Nbr_of_Customer_sites
	NLS2_0_LocalTail=2M	Nbr_of_Customer_sites
	NLS2_0_LocalTail>2M	Nbr_of_Customer_sites
	NLS2_1_Access_into_VirtualPath	Configured_Bandwidth(Gbps)
	NLS2_1_ADSL_SDSL_Bitstream	Nbr_of_used_xDSL_BROBA_lines
	NLS2_1_Backbone_UnicastVLAN_Transport_IntraRegion	EthanePeakHour PeakBandwidth_used(Mbps)
	NLS2_1_Backbone_VirtualPath_InterArea	VP bandwidth Gbps
	NLS2_1_Backbone_VirtualPath_IntraArea	VP equivalent bandwidth Gbps (Topological efficiency and QoS aspects are translated in bandwidth +or-committed bandwidth)
	NLS2_1_Backbone_VirtualPath_Local	VP equivalent bandwidth Gbps (Topological efficiency and QoS aspects are translated in bandwidth +or-committed bandwidth)
	NLS2_1_BackboneCapacity_Ethernet>=10M	Bandwidth consumed (Mbit/s)
	NLS2_1_InterCityBackboneCapacity_Ethernet>=10M	Bandwidth consumed (Mbit/s)
NLS2_1_LocalTail_PrivateVLAN_transport_lowEnd	Direct	
NLS2_1_LocalTailCapacity_Ethernet>=10M	Bandwidth consumed (Mbit/s)	
NSF_Dedicated_Access_to_PrivatelP	Nbr_of_Sites	
Symmetric Public_IP_Extension	NLS2_0_InterCityBackboneCapacity=2M	Bandwidth consumed (Mbit/s)
	NLS2_0_IntrazonalBackboneCapacity=2M	Bandwidth consumed (Mbit/s)
	NLS2_0_LocalBackboneCapacity=2M	Bandwidth consumed (Mbit/s)

	NLS2_0_LocalTail=2M	Nbr_of_Customer_sites
	NLS2_1_BackboneCapacity_Ethernet>=10M	Bandwidth consumed (Mbit/s)
	NLS2_1_LocalTailCapacity_Ethernet>=10M	Bandwidth consumed (Mbit/s)
Public_IP_collection	NLS2_0_InterCityBackboneCapacity>2M	Bandwidth consumed (Mbit/s)
	NLS2_0_IntraAreaBackboneCapacity>2M	Bandwidth consumed (Mbit/s)
	NLS2_0_IntrazonalBackboneCapacity>2M	Bandwidth consumed (Mbit/s)
	NLS2_0_LocalBackboneCapacity>2M	Bandwidth consumed (Mbit/s)
	NLS2_1_ADSL_SDSL_Bitstream	Nbr_of_used_xDSL_BROBA_lines
	NLS2_1_Backbone_UnicastVLAN_Transport_IntraRegion	EthanePeakHour PeakBandwidth_used(Mbps)
	NLS2_1_Backbone_VirtualPath_InterArea	VP bandwidth Gbps
	NLS2_1_Backbone_VirtualPath_IntraArea	VP equivalent bandwidth Gbps (Topological efficiency and QoS aspects are translated in bandwidth +or-committed bandwidth)
	NLS2_1_Backbone_VirtualPath_Local	VP equivalent bandwidth Gbps (Topological efficiency and QoS aspects are translated in bandwidth +or-committed bandwidth)
	NLS2_1_VDSL_Bitstream	Nbr_of_used_VDSL_lines
NSF_BroadBand_Public_IP_Collect	PeakHour_PublicInternetTraffic(Gbps)	
VoD_IP_collection	NLS2_1_ADSL_SDSL_Bitstream	Nbr_of_used_xDSL_BROBA_lines
	NLS2_1_Backbone_UnicastVLAN_Transport_IntraRegion	EthanePeakHour PeakBandwidth_used(Mbps)
	NLS2_1_VDSL_Bitstream	Nbr_of_used_VDSL_lines
	NSF_BroadBand_VoD_IP_Collect	PeakHour_VoDTraffic(Gbps)
VoIP_IP_collection	NLS2_1_Backbone_Pseudowire_InterCity	TotalPeakBandwidth_used(Gbps)
	NLS2_1_Backbone_UnicastVLAN_Transport_IntraRegion	EthanePeakHour PeakBandwidth_used(Mbps)
	NSF_BroadBand_VoIP_IP_Collect	Direct
Public_IP_switching	NLS2_0_InterCityBackboneCapacity=2M	Bandwidth consumed (Mbit/s)
	NLS2_0_InterCityBackboneCapacity>2M	Bandwidth consumed (Mbit/s)
	NLS2_0_IntrazonalBackboneCapacity=2M	Bandwidth consumed (Mbit/s)
	NLS2_0_IntrazonalBackboneCapacity>2M	Bandwidth consumed (Mbit/s)
	NLS2_0_LocalBackboneCapacity=2M	Bandwidth consumed (Mbit/s)
	NLS2_0_LocalBackboneCapacity>2M	Bandwidth consumed (Mbit/s)
	NLS2_1_BackboneCapacity_Ethernet>=10M	Bandwidth consumed (Mbit/s)
	NLS2_1_InterCityBackboneCapacity_Ethernet>=10M	Bandwidth consumed (Mbit/s)

	NLS2_1_LocalTailCapacity_Ethernet>=10M	Bandwidth consumed (Mbit/s)
	NSF_PublicInternetSwitching	TotalPeakHour_PublicInternetTraffic(Gbps)
Private_IP&Ethernet_Routing	NLS2_0_IntrazonalBackboneCapacity=2M	Bandwidth consumed (Mbit/s)
	NLS2_0_LocalBackboneCapacity=2M	Bandwidth consumed (Mbit/s)
	NLS2_0_LocalBackboneCapacity>2M	Bandwidth consumed (Mbit/s)
	NLS2_1_Backbone_Pseudowire_InterCity	TotalPeakBandwidth_used(Gbps)
	NLS2_1_Backbone_VirtualPath_InterArea	VP bandwidth Gbps
	NLS2_1_Backbone_VirtualPath_IntraArea	VP equivalent bandwidth Gbps (Topological efficiency and QoS aspects are translated in bandwidth +or-committed bandwidth)
	NLS2_1_Backbone_VirtualPath_Local	VP equivalent bandwidth Gbps (Topological efficiency and QoS aspects are translated in bandwidth +or-committed bandwidth)
	NLS2_1_BackboneCapacity_Ethernet>=10M	Bandwidth consumed (Mbit/s)
	NLS2_1_InterCityBackboneCapacity_Ethernet>=10M	Bandwidth consumed (Mbit/s)
	NSF_PrivateIPSwitching	Direct
IP_security	NSF_IP_security	Direct

7.8 Network Services of the application layer

7.8.1 Definition

This layer deals with the telecommunication application services to end users. The application layer services are :

NLS4_0_BroadcastTV, NLS4_0_VoD, NLS4_0_iDTV and voice telephony related services classified as follows:

CLASS	DEF_NLS_DESCR
Access to VoiceCallHandling	NLS4_0_Voice_traffic_AreaLevel_Aggregate_Deaggregate NLS4_0_Voice_traffic_AreaLevel_PointOfInterconnect NLS4_0_Voice_traffic_Local_Aggregate_Deaggregate NLS4_0_Voice_traffic_Local_PointOfInterconnect
NP	NLS4_0_FixedPortableNumberLocation NLS4_0_Public_NumberPortability
Telephony Access	NLS4_0_ISDN_access NLS4_0_ISDN-PRA_access NLS4_0_PSTN_access
VAS application	NLS4_0_Advanced_Number_Translation_CallHandling

	NLS4_0_CallerIdentity_CallHandling
	NLS4_0_CallingCard_CallHandling
	NLS4_0_InteractiveVoiceResponse_CallHandling
	NLS4_0_MessageWaitingIndicator_Inserting
	NLS4_0_OtherAdvanced_CallHandling
	NLS4_0_PrepaidCallingCard_CallHandling
	NLS4_0_Service_Announcements_Playing
	NLS4_0_Televoting_CallHandling
	NLS4_0_VirtualPrivateNetwork_CallHandling
	NLS4_0_VoiceFeatures_SelfManaging
	NLS4_0_Voicemail&Messaging
	NLS4_0_WakeUp_CallHandling
Voice transport	NLS4_0_RemotelyAggregatedVoice_transport
	NLS4_0_SwitchedVoice_transport_CAE_CAE
	NLS4_0_FixedSwitchedVoice_transport_National_offnet
	NLS4_0_SwitchedVoice_transport_LEX_CAE
	NLS4_0_BGC MobileSwitchedVoice_transport_National_offnet
	NLS4_0_SwitchedVoice_transport_CAE_MSC
	NLS4_0_SwitchedVoice_transport_LEX_MSC
VoiceCallHandling	NLS4_0_Voice_traffic_AreaLevel_Collect
	NLS4_0_Voice_traffic_AreaLevel_Complete
	NLS4_0_Voice_traffic_AreaLevel_Terminate
	NLS4_0_Voice_traffic_AreaLevel_Transit
	NLS4_0_Voice_traffic_Local_Collect
	NLS4_0_Voice_traffic_Local_Complete
	NLS4_0_Voice_traffic_Local_Terminate
Mobile Voice&Data Handling	NLS4_0_BGC Mobile_Access_Collect
	NLS4_0_BGC Mobile_Access_Distribute
	NLS4_0_BGC Mobile_BackBone
Special	NLS4_0_Automated_call_distribution
	NLS4_0_PublicPayphones
Other special	NLS4_0_InternetDialUp_CallHandling

For the access, the voice application services are end-to-end voice connections between the customer site and the central office (technical building closest to the user) . For the backbone voice applications are either pure call handling related and do not span over distant nodes, or they are voice transport applications between distant nodes . Next picture puts into perspective the services of the Voice application layer.

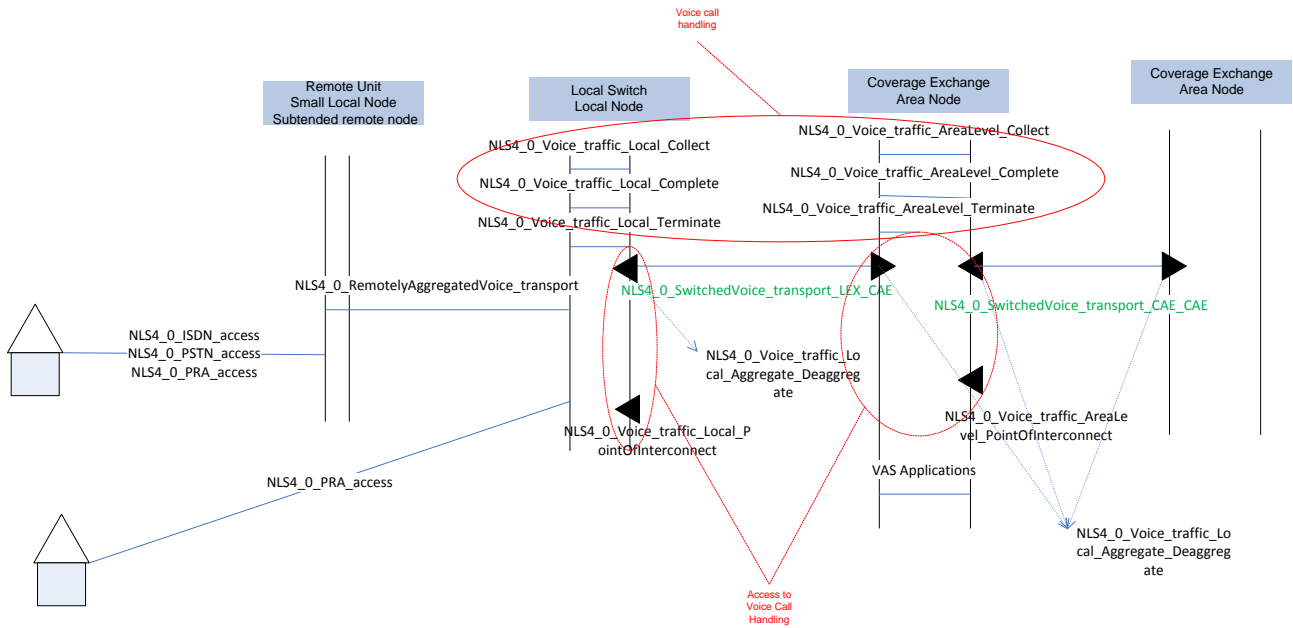

Figure 26: the services of the Voice application layer 4.0

7.8.2 Usage of the application layer

The TV related applications are completely used for iDTV end-user services, no specific consumption driver needs to be defined.

The voice application services are distributed to a variety of traffic types , each with a specific driver. The following table summarizes the used drivers per voice application service.

Class of application service	Voice application service	Driver to distribute the NLS4.0 application service to EUS or NLS4.1
Access to VoiceCallHandling	NLS4_0_Voice_traffic_AreaLevel_Aggregate_Deaggregate	routed minutes
	NLS4_0_Voice_traffic_AreaLevel_PointOfInterconnect	TimeSlotEquivalent_capacity_used
	NLS4_0_Voice_traffic_Local_Aggregate_Deaggregate	routed minutes
	NLS4_0_Voice_traffic_Local_PointOfInterconnect	TimeSlotEquivalent_capacity_used
NP	NLS4_0_FixedPortableNumberLocation	Nbr_calls
	NLS4_0_Public_NumberPortability	Nbr_of_ported_numbers
Telephony Access	NLS4_0_ISDN_access	Nbr_lines_inUse
	NLS4_0_ISDN-PRA_access	Nbr_lines_inUse
	NLS4_0_PSTN_access	Nbr_lines_inUse
VAS application	NLS4_0_CallerIdentity_CallHandling	direct
	NLS4_0_CallingCard_CallHandling	direct
	NLS4_0_InteractiveVoiceResponse_CallHandling	direct
	NLS4_0_MessageWaitingIndicator_Inserting	direct
	NLS4_0_OtherAdvanced_CallHandling	Direct
	NLS4_0_PrepaidCallingCard_CallHandling	Direct
	NLS4_0_Service_Announcements_Playing	Nbr_calls
	NLS4_0_Tele voting_CallHandling	Nbr_calls_explosive_traffic
	NLS4_0_VirtualPrivateNetwork_CallHandling	direct
	NLS4_0_VoiceFeatures_SelfManaging	direct

Voice transport	NLS4_0_Voicemail&Messaging	direct
	NLS4_0_WakeUp_CallHandling	direct
	NLS4_0_RemotelyAggregatedVoice_transport	routed minutes
	NLS4_0_SwitchedVoice_transport_CAE_CAE	routed minutes
	NLS4_0_FixedSwitchedVoice_transport_National_offnet	TimeSlotEquivalent_capacity_used
VoiceCallHandling	NLS4_0_SwitchedVoice_transport_LEX_CAE	routed minutes
	NLS4_0_BGC	
	MobileSwitchedVoice_transport_National_offnet	routed minutes
	NLS4_0_SwitchedVoice_transport_CAE_MSC	routed minutes
	NLS4_0_SwitchedVoice_transport_LEX_MSC	routed minutes
	NLS4_0_Voice_traffic_AreaLevel_Collect	routed minutes
	NLS4_0_Voice_traffic_AreaLevel_Complete	routed minutes
	NLS4_0_Voice_traffic_AreaLevel_Terminate	routed minutes
	NLS4_0_Voice_traffic_AreaLevel_Transit	routed minutes
	NLS4_0_Voice_traffic_Local_Collect	routed minutes
NLS4_0_Voice_traffic_Local_Complete	routed minutes	
NLS4_0_Voice_traffic_Local_Terminate	routed minutes	
Mobile Voice&Data Handling	NLS4_0_BGC Mobile_Access_Collect	routed minutes
	NLS4_0_BGC Mobile_Access_Distribute	routed minutes
	NLS4_0_BGC Mobile_BackBone	routed minutes

The driver “routed minutes” consists in determining the average nbr of times (=routing factor) a traffic type is using the voice application service across all possible call scenarios compatible with the traffic type. The routed minutes result from multiplication of the routing factor with the amount of calls (expressed in minutes) of that traffic type.

The traffic types (“consumers”) of these voice applications are:

Class of voice application	Traffic type
Access to VoiceCallHandling	EUS_BGC Fixed National Transit (M)OLO traffic EAA interconnection
	EUS_BGC Fixed to BGC Mobile
	EUS_BGC Mobile National outg. FOLO
	EUS_BGC Mobile to BGC Fixed
	EUS_BGC Mobile_Roaming Out Origination
	EUS_Carrier PreSelection IAA interconnection
	EUS_Consultel 090x Traffic - BGC Fixed&Mobile to FOLO
	EUS_EAA interconnection - (M)FOLO to BGC Fixed
	EUS_EAA interconnection - BGC Fixed to FOLO
	EUS_EAA interconnection - BGC Fixed to MOLO
	EUS_Freephone Traffic - BGC fixed and Mobile to FOLO
	EUS_IAA interconnection - BGC Fixed to MOLO
	EUS_IAA interconnection - MOLO to BGC Fixed
	EUS_Mobile_Roaming IN Origination
	EUS_MVAS - BGC Fixed
	EUS_Split Charging Traffic - BGC Fixed&Mobile to FOLO
	EUS_Universal Access Number Traffic - BGC Fixed&Mobile to FOLO
	EUS_Voice_traffic_IAA_PointOfInterconnect subscription
	EUS_Voice_traffic_Local_PointOfInterconnect subscription
	NLS4_1 BVAS - BGC Fixed
NLS4_1_EAA BGC Fixed_On net Voice	

	NLS4_1_IAA BGC Fixed_On net Voice
	NLS4_1_IAA interconnection - BGC Fixed to FOLO
	NLS4_1_IAA interconnection - FOLO to BGC Fixed
	NLS4_1_Incoming International Traffic - BGC Fixed
	NLS4_1_Outgoing International Traffic - BGC Fixed
	NLS4_1_Transit International (M)OLO Traffic EAA
Mobile Voice&Data Handling	EUS_BGC Fixed National Transit (M)OLO traffic IAA interconnection
	EUS_BGC Fixed to BGC Mobile
	EUS_BGC Mobile international traffic incoming
	EUS_BGC Mobile National outg. FOLO
	EUS_BGC Mobile Outgoing to International Traffic
	EUS_BGC Mobile to BGC Fixed
	EUS_BGC Mobile to BGC Mobile
	EUS_BGC Mobile_Incoming SMS international
	EUS_BGC Mobile_Incoming SMS national
	EUS_Consultel 090x Traffic - BGC Fixed&Mobile to FOLO
	EUS_Freephone Traffic - BGC fixed and Mobile to FOLO
	EUS_Interconnection BGC Mobile to MOLO
	EUS_Interconnection FOLO to BGC Mobile
	EUS_Interconnection MOLO to BGC Mobile
	EUS_Mobile_Data national
	EUS_Mobile_On net SMS
	EUS_Mobile_Outgoing SMS_international
	EUS_Mobile_Outgoing SMS_national
	EUS_Mobile_Roaming IN Origination
	EUS_Mobile_Roaming IN Termination
	EUS_Mobile_Roaming IN_Data
	EUS_Mobile_Roaming IN_Originating_SMS
	EUS_Mobile_Roaming IN_Terminating_SMS
	EUS_Split Charging Traffic - BGC Fixed&Mobile to FOLO
	EUS_Universal Access Number Traffic - BGC Fixed&Mobile to FOLO
	NLS4_1 BVAS - BGC Fixed
NP	EUS_BGC Fixed National Transit (M)OLO traffic EAA interconnection
	EUS_BGC Fixed National Transit (M)OLO traffic IAA interconnection
	EUS_EAA interconnection - BGC Fixed to FOLO
	EUS_IAA interconnection - BGC Fixed to FOLO
	EUS_Incoming International Transit (M)OLO Traffic
	EUS_Other_Traffic - BGC Fixed
	EUS_Number Portability access per line subscription
Special	EUS_AUTOMATEDCALLDISTRIBUTION
	EUS_Payph operations - BGC Fixed
Telephony Access	EUS_ISDN-BA Access - subscription
	EUS_Private_IP&Ethernet_on_backup
	EUS_ISDN-PRA Access - subscription
	EUS_PSTN Access - subscription
VAS application	EUS_BGC Fixed DCIA traffic
	EUS_BGC Fixed international traffic incoming
	EUS_BGC Fixed interzonal traffic

EUS_BGC Fixed local traffic
 EUS_BGC Fixed National Transit (M)OLO traffic IAA interconnection
 EUS_BGC Fixed zonal non local traffic
 EUS_BVAS Call & Conference - BGC fixed
 EUS_Calling Card Postpaid Traffic - BGC Fixed
 EUS_Carrier PreSelection IAA interconnection
 EUS_Carrier PreSelection local interconnection
 EUS_Consultel 090x Traffic - (M)FOLO to BGC Fixed
 EUS_Consultel 090x Traffic - BGC Fixed&Mobile to BGC
 EUS_Freephone Traffic - BGC Fixed&Mobile to BGC
 EUS_IAA interconnection - BGC Fixed to MOLO
 EUS_IAA interconnection - MOLO to BGC Fixed
 EUS_Local interconnection - FOLO to BGC Fixed
 EUS_MVAS - BGC Fixed
 EUS_notAllocated
 EUS_OPS International Information Traffic - BGC
 EUS_OPS National Information Traffic - BGC
 EUS_Other_Traffic - BGC Fixed
 EUS_Payph operations - BGC Fixed
 NLS4_1_IAA interconnection - BGC Fixed to FOLO
 NLS4_1_IAA interconnection - FOLO to BGC Fixed
 NLS4_1_Outgoing International Traffic - BGC Fixed

Voice transport

EUS_BGC Fixed National Transit (M)OLO traffic EAA interconnection
 EUS_BGC Fixed National Transit (M)OLO traffic IAA interconnection
 EUS_BGC Fixed to BGC Mobile
 EUS_BGC Mobile international traffic incoming
 EUS_BGC Mobile National outg. FOLO
 EUS_BGC Mobile Outgoing to International Traffic
 EUS_BGC Mobile to BGC Fixed
 EUS_BGC Mobile_Incoming SMS international
 EUS_BGC Mobile_Incoming SMS national
 EUS_BGC Mobile_Roaming Out Origination
 EUS_BGC Mobile_Roaming Out Termination
 EUS_Carrier PreSelection local interconnection
 EUS_Consultel 090x Traffic - BGC Fixed&Mobile to FOLO
 EUS_EAA interconnection - (M)FOLO to BGC Fixed
 EUS_EAA interconnection - BGC Fixed to FOLO
 EUS_EAA interconnection - BGC Fixed to MOLO
 EUS_Freephone Traffic - BGC fixed and Mobile to FOLO
 EUS_IAA interconnection - BGC Fixed to MOLO
 EUS_IAA interconnection - MOLO to BGC Fixed
 EUS_Interconnection BGC Mobile to MOLO
 EUS_Interconnection FOLO to BGC Mobile
 EUS_Interconnection MOLO to BGC Mobile
 EUS_Local interconnection - FOLO to BGC Fixed
 EUS_Mobile_Outgoing SMS_international
 EUS_Mobile_Outgoing SMS_national
 EUS_Mobile_Roaming IN Origination
 EUS_Mobile_Roaming IN Termination

EUS_Mobile_Roaming_IN_Originating_SMS
EUS_MVAS - BGC Fixed
EUS_Split Charging Traffic - BGC Fixed&Mobile to FOLO
EUS_Universal Access Number Traffic - BGC Fixed&Mobile to FOLO
NLS4_1_BVAS - BGC Fixed
NLS4_1_EAA BGC Fixed_On net Voice
NLS4_1_IAA BGC Fixed_On net Voice
NLS4_1_IAA interconnection - BGC Fixed to FOLO
NLS4_1_IAA interconnection - FOLO to BGC Fixed
NLS4_1_Incoming International Traffic - BGC Fixed
NLS4_1_Local BGC Fixed_On net Voice
NLS4_1_Outgoing International Traffic - BGC Fixed
NLS4_1_Transit International (M)OLO Traffic EAA

VoiceCallHandling

EUS_BGC Fixed National Transit (M)OLO traffic EAA interconnection
EUS_BGC Fixed National Transit (M)OLO traffic IAA interconnection
EUS_BGC Fixed to BGC Mobile
EUS_BGC Mobile National outg. FOLO
EUS_BGC Mobile to BGC Fixed
EUS_BGC Mobile_Roaming Out Origination
EUS_Carrier PreSelection IAA interconnection
EUS_Carrier PreSelection local interconnection
EUS_Consultel 090x Traffic - BGC Fixed&Mobile to FOLO
EUS_EAA interconnection - (M)FOLO to BGC Fixed
EUS_EAA interconnection - BGC Fixed to FOLO
EUS_EAA interconnection - BGC Fixed to MOLO
EUS_Freephone Traffic - BGC fixed and Mobile to FOLO
EUS_IAA interconnection - BGC Fixed to MOLO
EUS_IAA interconnection - MOLO to BGC Fixed
EUS_Local interconnection - FOLO to BGC Fixed
EUS_Mobile_Roaming IN Origination
EUS_MVAS - BGC Fixed
EUS_Split Charging Traffic - BGC Fixed&Mobile to FOLO
EUS_Universal Access Number Traffic - BGC Fixed&Mobile to FOLO
NLS4_1_BVAS - BGC Fixed
NLS4_1_EAA BGC Fixed_On net Voice
NLS4_1_IAA BGC Fixed_On net Voice
NLS4_1_IAA interconnection - BGC Fixed to FOLO
NLS4_1_IAA interconnection - FOLO to BGC Fixed
NLS4_1_Incoming International Traffic - BGC Fixed
NLS4_1_Local BGC Fixed_On net Voice
NLS4_1_Outgoing International Traffic - BGC Fixed
NLS4_1_Transit International (M)OLO Traffic EAA
NLS4_1_Transit International (M)OLO Traffic IAA

Other special

EUS_internet traffic - FOLO to BGC 0909/3 IAA
EUS_Other_Traffic - BGC Fixed

Below table gives a view on fixed or mobile related traffic types (“consumers”) of those voice applications:

traffic category	Voice application service	EUS or NLS4_1
mobile traffic related	NLS4_0_BGC Mobile_Access_Collect	EUS_BGC Mobile National outg. FOLO EUS_BGC Mobile Outgoing to International Traffic EUS_BGC Mobile to BGC Fixed EUS_BGC Mobile to BGC Mobile EUS_Interconnection BGC Mobile to MOLO EUS_Mobile_Data national EUS_Mobile_On net SMS EUS_Mobile_Outgoing SMS_international EUS_Mobile_Outgoing SMS_national EUS_Mobile_Roaming IN Origination EUS_Mobile_Roaming IN_Data EUS_Mobile_Roaming IN_Originating_SMS NLS4_1 BVAS - BGC Fixed EUS_Constutel 090x Traffic - BGC Fixed&Mobile to FOLO EUS_Freephone Traffic - BGC fixed and Mobile to FOLO EUS_Split Charging Traffic - BGC Fixed&Mobile to FOLO EUS_Universal Access Number Traffic - BGC Fixed&Mobile to FOLO
	NLS4_0_BGC Mobile_Access_Distribute	EUS_BGC Fixed National Transit (M)OLO traffic IAA interconnection EUS_BGC Fixed to BGC Mobile EUS_BGC Mobile international traffic incoming EUS_BGC Mobile to BGC Mobile EUS_BGC Mobile_Incoming SMS international EUS_BGC Mobile_Incoming SMS national EUS_Interconnection FOLO to BGC Mobile EUS_Interconnection MOLO to BGC Mobile EUS_Mobile_On net SMS EUS_Mobile_Roaming IN Origination EUS_Mobile_Roaming IN Termination EUS_Mobile_Roaming IN_Originating_SMS EUS_Mobile_Roaming IN_Terminating_SMS
	NLS4_0_BGC Mobile_Backbone	EUS_BGC Fixed National Transit (M)OLO traffic IAA interconnection EUS_BGC Fixed to BGC Mobile EUS_BGC Mobile international traffic incoming EUS_BGC Mobile National outg. FOLO EUS_BGC Mobile Outgoing to International Traffic EUS_BGC Mobile to BGC Fixed EUS_BGC Mobile to BGC Mobile EUS_BGC Mobile_Incoming SMS international EUS_BGC Mobile_Incoming SMS national EUS_Interconnection BGC Mobile to MOLO EUS_Interconnection FOLO to BGC Mobile

	EUS_Interconnection MOLO to BGC Mobile
	EUS_Mobile_Data national
	EUS_Mobile_On net SMS
	EUS_Mobile_Outgoing SMS_international
	EUS_Mobile_Outgoing SMS_national
	EUS_Mobile_Roaming IN Origination
	EUS_Mobile_Roaming IN Termination
	EUS_Mobile_Roaming IN_Data
	EUS_Mobile_Roaming IN_Originating_SMS
	EUS_Mobile_Roaming IN_Terminating_SMS
	NLS4_1 BVAS - BGC Fixed
	EUS_Consumtel 090x Traffic - BGC Fixed&Mobile to FOLO
	EUS_Freephone Traffic - BGC fixed and Mobile to FOLO
	EUS_Split Charging Traffic - BGC Fixed&Mobile to FOLO
	EUS_Universal Access Number Traffic - BGC Fixed&Mobile to FOLO
NLS4_0_MobileSwitchedVoice_transport_National_offnet	EUS_BGC Mobile Outgoing to International Traffic
	EUS_BGC Mobile_Roaming Out Termination
	EUS_Interconnection BGC Mobile to MOLO
	EUS_Mobile_Outgoing SMS_international
	EUS_Mobile_Outgoing SMS_national
	EUS_Mobile_Roaming IN Origination
	EUS_Mobile_Roaming IN_Originating_SMS
	EUS_Mobile_Roaming IN Termination
	EUS_BGC Mobile international traffic incoming
	EUS_Interconnection MOLO to BGC Mobile
	EUS_Interconnection FOLO to BGC Mobile
	EUS_BGC Mobile_Incoming SMS national
	EUS_BGC Mobile_Incoming SMS international
NLS4_0_RemotelyAggregatedVoice_transport	EUS_BGC Fixed to BGC Mobile
	EUS_BGC Mobile to BGC Fixed
	EUS_BGC Mobile_Roaming Out Origination
	EUS_Mobile_Roaming IN Origination
	NLS4_1_Outgoing International Traffic - BGC Fixed
NLS4_0_SwitchedVoice_transport_CAE_MSC	EUS_BGC Fixed National Transit (M)OLO traffic IAA interconnection
	EUS_BGC Fixed to BGC Mobile
	EUS_BGC Mobile National outg. FOLO
	EUS_BGC Mobile to BGC Fixed
	EUS_Mobile_Roaming IN Origination
	NLS4_1 BVAS - BGC Fixed
	EUS_Consumtel 090x Traffic - BGC Fixed&Mobile to FOLO
	EUS_Freephone Traffic - BGC fixed and Mobile to FOLO
	EUS_Split Charging Traffic - BGC Fixed&Mobile to FOLO
	EUS_Universal Access Number Traffic - BGC Fixed&Mobile to FOLO
NLS4_0_SwitchedVoice_transport_LEX_CAE	EUS_BGC Fixed to BGC Mobile
	EUS_BGC Mobile to BGC Fixed
	EUS_BGC Mobile_Roaming Out Origination
	EUS_Mobile_Roaming IN Origination
	NLS4_1_Outgoing International Traffic - BGC Fixed

NLS4_0_SwitchedVoice_transport_LEX_MSC	EUS_BGC Mobile to BGC Fixed EUS_Mobile_Roaming IN Origination
NLS4_0_Voice_traffic_AreaLevel_Aggregate_Deaggregate	EUS_BGC Fixed to BGC Mobile EUS_BGC Mobile to BGC Fixed EUS_BGC Mobile_Roaming Out Origination EUS_Mobile_Roaming IN Origination NLS4_1_Outgoing International Traffic - BGC Fixed EUS_BGC Fixed to BGC Mobile NLS4_1_Outgoing International Traffic - BGC Fixed
NLS4_0_Voice_traffic_AreaLevel_Collect	EUS_BGC Fixed to BGC Mobile NLS4_1_Outgoing International Traffic - BGC Fixed
NLS4_0_Voice_traffic_AreaLevel_PointOfInterconnect	EUS_BGC Fixed to BGC Mobile EUS_BGC Mobile National outg. FOLO EUS_BGC Mobile to BGC Fixed EUS_BGC Mobile_Roaming Out Origination EUS_Mobile_Roaming IN Origination NLS4_1_Outgoing International Traffic - BGC Fixed NLS4_1 BVAS - BGC Fixed EUS_Consultel 090x Traffic - BGC Fixed&Mobile to FOLO EUS_Freephone Traffic - BGC fixed and Mobile to FOLO EUS_Split Charging Traffic - BGC Fixed&Mobile to FOLO EUS_Universal Access Number Traffic - BGC Fixed&Mobile to FOLO
NLS4_0_Voice_traffic_AreaLevel_Terminate	EUS_BGC Mobile to BGC Fixed EUS_BGC Mobile_Roaming Out Origination EUS_Mobile_Roaming IN Origination NLS4_1 BVAS - BGC Fixed
NLS4_0_Voice_traffic_AreaLevel_Transit	EUS_BGC Fixed National Transit (M)OLO traffic IAA interconnection EUS_BGC Fixed National Transit (M)OLO traffic EAA interconnection EUS_BGC Mobile National outg. FOLO EUS_Mobile_Roaming IN Origination EUS_Consultel 090x Traffic - BGC Fixed&Mobile to FOLO EUS_Freephone Traffic - BGC fixed and Mobile to FOLO EUS_Split Charging Traffic - BGC Fixed&Mobile to FOLO EUS_Universal Access Number Traffic - BGC Fixed&Mobile to FOLO
NLS4_0_Voice_traffic_Local_Aggregate_Deaggregate	EUS_BGC Fixed to BGC Mobile EUS_BGC Mobile to BGC Fixed
NLS4_0_Voice_traffic_Local_Collect	EUS_BGC Mobile_Roaming Out Origination EUS_Mobile_Roaming IN Origination NLS4_1_Outgoing International Traffic - BGC Fixed EUS_BGC Fixed to BGC Mobile NLS4_1_Outgoing International Traffic - BGC Fixed
NLS4_0_Voice_traffic_Local_Terminate	EUS_BGC Mobile to BGC Fixed EUS_BGC Mobile_Roaming Out Origination EUS_Mobile_Roaming IN Origination
pure fixed traffic related	NLS4_0_FixedSwitchedVoice_transport_National_offnet EUS_EAA interconnection - BGC Fixed to FOLO EUS_EAA interconnection - BGC Fixed to MOLO NLS4_1_Outgoing International Traffic - BGC Fixed

NLS4_0_RemotelyAggregatedVoice_transport	<p>NLS4_1_IAA interconnection - BGC Fixed to FOLO</p> <p>EUS_IAA interconnection - BGC Fixed to MOLO</p> <p>EUS_Carrier PreSelection local interconnection</p> <p>EUS_EAA interconnection - BGC Fixed to FOLO</p> <p>EUS_EAA interconnection - BGC Fixed to MOLO</p> <p>EUS_EAA interconnection - (M)FOLO to BGC Fixed</p> <p>EUS_IAA interconnection - MOLO to BGC Fixed</p> <p>EUS_IAA interconnection - BGC Fixed to MOLO</p> <p>EUS_Local interconnection - FOLO to BGC Fixed</p> <p>EUS_MVAS - BGC Fixed</p> <p>NLS4_1 BVAS - BGC Fixed</p> <p>NLS4_1_EAA BGC Fixed_On net Voice</p> <p>NLS4_1_IAA BGC Fixed_On net Voice</p> <p>NLS4_1_IAA interconnection - BGC Fixed to FOLO</p> <p>NLS4_1_IAA interconnection - FOLO to BGC Fixed</p> <p>NLS4_1_Incoming International Traffic - BGC Fixed</p> <p>NLS4_1_Local BGC Fixed_On net Voice</p> <p>NLS4_1_Outgoing International Traffic - BGC Fixed</p>
NLS4_0_SwitchedVoice_transport_CAE_CAE	<p>EUS_BGC Fixed National Transit (M)OLO traffic EAA interconnection</p> <p>EUS_EAA interconnection - BGC Fixed to FOLO</p> <p>EUS_EAA interconnection - BGC Fixed to MOLO</p> <p>EUS_EAA interconnection - (M)FOLO to BGC Fixed</p> <p>NLS4_1_EAA BGC Fixed_On net Voice</p>
NLS4_0_SwitchedVoice_transport_LEX_CAE	<p>NLS4_1_Transit International (M)OLO Traffic EAA</p> <p>EUS_EAA interconnection - BGC Fixed to FOLO</p> <p>EUS_EAA interconnection - BGC Fixed to MOLO</p> <p>EUS_EAA interconnection - (M)FOLO to BGC Fixed</p> <p>EUS_IAA interconnection - MOLO to BGC Fixed</p> <p>EUS_IAA interconnection - BGC Fixed to MOLO</p> <p>EUS_MVAS - BGC Fixed</p> <p>NLS4_1 BVAS - BGC Fixed</p> <p>NLS4_1_EAA BGC Fixed_On net Voice</p> <p>NLS4_1_IAA BGC Fixed_On net Voice</p> <p>NLS4_1_IAA interconnection - BGC Fixed to FOLO</p> <p>NLS4_1_IAA interconnection - FOLO to BGC Fixed</p> <p>NLS4_1_Incoming International Traffic - BGC Fixed</p> <p>NLS4_1_Outgoing International Traffic - BGC Fixed</p>
NLS4_0_Voice_traffic_AreaLevel_Aggregate_Deaggragate	<p>EUS_BGC Fixed National Transit (M)OLO traffic EAA interconnection</p> <p>EUS_Carrier PreSelection IAA interconnection</p> <p>EUS_EAA interconnection - BGC Fixed to FOLO</p> <p>EUS_EAA interconnection - BGC Fixed to MOLO</p> <p>EUS_EAA interconnection - (M)FOLO to BGC Fixed</p> <p>EUS_IAA interconnection - MOLO to BGC Fixed</p> <p>EUS_IAA interconnection - BGC Fixed to MOLO</p> <p>EUS_MVAS - BGC Fixed</p> <p>NLS4_1 BVAS - BGC Fixed</p> <p>NLS4_1_EAA BGC Fixed_On net Voice</p> <p>NLS4_1_IAA BGC Fixed_On net Voice</p>

NLS4_0_Voice_traffic_AreaLevel_Collect	<p>NLS4_1_IAA interconnection - BGC Fixed to FOLO NLS4_1_IAA interconnection - FOLO to BGC Fixed NLS4_1_Incoming International Traffic - BGC Fixed NLS4_1_Outgoing International Traffic - BGC Fixed NLS4_1_Transit International (M)OLO Traffic EAA EUS_Carrier PreSelection IAA interconnection EUS_EAA interconnection - BGC Fixed to FOLO EUS_EAA interconnection - BGC Fixed to MOLO EUS_IAA interconnection - BGC Fixed to MOLO EUS_MVAS - BGC Fixed NLS4_1_EAA BGC Fixed_On net Voice NLS4_1_IAA interconnection - BGC Fixed to FOLO NLS4_1_Outgoing International Traffic - BGC Fixed</p>
NLS4_0_Voice_traffic_AreaLevel_Complete	<p>NLS4_1 BVAS - BGC Fixed NLS4_1_IAA BGC Fixed_On net Voice</p>
NLS4_0_Voice_traffic_AreaLevel_PointOfInterconnect	<p>EUS_EAA interconnection - BGC Fixed to FOLO EUS_EAA interconnection - BGC Fixed to MOLO EUS_IAA interconnection - BGC Fixed to MOLO NLS4_1_IAA interconnection - BGC Fixed to FOLO NLS4_1_Outgoing International Traffic - BGC Fixed EUS_Voice_traffic_IAA_PointOfInterconnect subscription</p>
NLS4_0_Voice_traffic_AreaLevel_Terminate	<p>EUS_EAA interconnection - (M)FOLO to BGC Fixed EUS_IAA interconnection - MOLO to BGC Fixed NLS4_1_EAA BGC Fixed_On net Voice NLS4_1_IAA interconnection - FOLO to BGC Fixed NLS4_1_Incoming International Traffic - BGC Fixed</p>
NLS4_0_Voice_traffic_AreaLevel_Transit	<p>EUS_BGC Fixed National Transit (M)OLO traffic EAA interconnection EUS_BGC Fixed National Transit (M)OLO traffic IAA interconnection EUS_EAA interconnection - BGC Fixed to FOLO EUS_EAA interconnection - BGC Fixed to MOLO EUS_EAA interconnection - (M)FOLO to BGC Fixed NLS4_1_Transit International (M)OLO Traffic EAA NLS4_1_Transit International (M)OLO Traffic IAA</p>
NLS4_0_Voice_traffic_Local_Aggregate_Deaggregate	<p>EUS_Carrier PreSelection IAA interconnection EUS_EAA interconnection - BGC Fixed to FOLO EUS_EAA interconnection - BGC Fixed to MOLO EUS_EAA interconnection - (M)FOLO to BGC Fixed EUS_IAA interconnection - MOLO to BGC Fixed EUS_IAA interconnection - BGC Fixed to MOLO EUS_MVAS - BGC Fixed NLS4_1 BVAS - BGC Fixed NLS4_1_EAA BGC Fixed_On net Voice NLS4_1_IAA BGC Fixed_On net Voice NLS4_1_IAA interconnection - BGC Fixed to FOLO NLS4_1_IAA interconnection - FOLO to BGC Fixed NLS4_1_Incoming International Traffic - BGC Fixed NLS4_1_Outgoing International Traffic - BGC Fixed</p>
NLS4_0_Voice_traffic_Local_Collect	<p>EUS_Carrier PreSelection IAA interconnection</p>

	EUS_Carrier PreSelection local interconnection
	EUS_EAA interconnection - BGC Fixed to FOLO
	EUS_EAA interconnection - BGC Fixed to MOLO
	EUS_IAA interconnection - BGC Fixed to MOLO
	EUS_MVAS - BGC Fixed
	NLS4_1 BVAS - BGC Fixed
	NLS4_1_EAA BGC Fixed_On net Voice
	NLS4_1_IAA BGC Fixed_On net Voice
	NLS4_1_IAA interconnection - BGC Fixed to FOLO
	NLS4_1_Outgoing International Traffic - BGC Fixed
NLS4_0_Voice_traffic_Local_Complete	NLS4_1_Local BGC Fixed_On net Voice
NLS4_0_Voice_traffic_Local_PointOfInterconnect	EUS_Voice_traffic_Local_PointOfInterconnect subscription
NLS4_0_Voice_traffic_Local_Terminate	EUS_EAA interconnection - (M)FOLO to BGC Fixed
	EUS_IAA interconnection - MOLO to BGC Fixed
	EUS_Local interconnection - FOLO to BGC Fixed
	NLS4_1 BVAS - BGC Fixed
	NLS4_1_EAA BGC Fixed_On net Voice
	NLS4_1_IAA BGC Fixed_On net Voice
	NLS4_1_IAA interconnection - FOLO to BGC Fixed
	NLS4_1_Incoming International Traffic - BGC Fixed

7.8.3 Contributors to the application services

TV services

The broadcast TV application service is the result of the video streaming network stage function and the nation wide broadcast using the SDH clusters and simultaneously the multicast features of the Ethernet/MPLS regional clusters combined with the express pseudowires in order to reach all regional clusters.

Contributor to NLS4_0_BroadcastTV	Driver
NSF_BroadcastTV	Nbr_TV_users
NLS1_0_Fibre_connect_to_the_OpticalNode	Nb_access_fibres_used
NLS2_0_InterCityBackboneCapacity<2M	Bandwidth consumed (Mbit/s)
NLS2_0_InterCityBackboneCapacity=2M	Bandwidth consumed (Mbit/s)
NLS2_0_InterCityBackboneCapacity>2M	Bandwidth consumed (Mbit/s)
NLS2_0_IntraAreaBackboneCapacity<2M	Bandwidth consumed (Mbit/s)
NLS2_0_IntraAreaBackboneCapacity=2M	Bandwidth consumed (Mbit/s)
NLS2_0_IntraAreaBackboneCapacity>2M	Bandwidth consumed (Mbit/s)

NLS2_0_IntrazonalBackboneCapacity>2M	Bandwidth consumed (Mbit/s)
NLS2_0_LocalBackboneCapacity>2M	Bandwidth consumed (Mbit/s)
NLS2_1_Backbone_MulticastVPLS_IntraRegion	Direct
NLS2_1_Backbone_Pseudowire_InterCity	TotalPeakBandwidth_used(Gbps)
NLS2_1_BackboneCapacity_Ethernet>=10M	Bandwidth consumed (Mbit/s)
NLS2_1_InterCityBackboneCapacity_Ethernet>=10M	Bandwidth consumed (Mbit/s)
NLS2_1_LocalTailCapacity_Ethernet>=10M	Bandwidth consumed (Mbit/s)

Similarly, the Video On Demand service is the result of Video Movie servers delivering the content and the transport services towards the closest local node to the customer . The transport is realized on the Ethernet/MPLS network.

Contributor to NLS4_0_VoD	Driver
NLS3_VoD_IP_collection	direct
NSF_VoD	Nbr_TV_users

Voice application services in the access

PSTN and ISDN access services are the result of the voice concentrator function in the closest technical building (local switch or remote unit) and the physical copper connectivity between the customer site and the technical building. In addition, the data connectivity required to transport Voice over IP signaling and traffic to the Voice over IP switching units is also included as a contributor to voice access.

PRA access services do not need a concentrator function (that function is typically realized within the customer site by private switches) but merely a voice transport link to the local switch. This one is obtained directly from layer 2.0 transport segments and local tails.

Hereunder a summary of the contributors to voice access together with the drivers used to determine their level of involvement in the service.

Voice access service	Contributor	Driver Name
NLS4_0_ISDN_access	NLS1_0_Continue_Raw_Copper	Nbr_of_used_pairs
	NLS1_0_Raw_Copper	Nbr_of_used_pairs
	NSF_ISDN_NetworkTermination	Nbr_of_accesses
	NSF_ISDN_Voice_concentrator	Nbr_lines_inUse
NLS4_0_PSTN_access	NLS1_0_Continue_Raw_Copper	Nbr_of_used_pairs
	NLS1_0_Raw_Copper	Nbr_of_used_pairs
	NLS3_VoIP_IP_collection	Direct
	NSF_PairGainSystem	Direct
NLS4_0_ISDN-PRA_access	NSF_PSTN_Voice_concentrator	Nbr_lines_inUse
	NLS2_0_InterCityBackboneCapacity=2M	Bandwidth consumed (Mbit/s)

NLS2_0_IntraAreaBackboneCapacity=2M	Bandwidth consumed (Mbit/s)
NLS2_0_IntrazonalBackboneCapacity=2M	Bandwidth consumed (Mbit/s)
NLS2_0_LocalBackboneCapacity=2M	Bandwidth consumed (Mbit/s)
NLS2_0_LocalTailCapacity	Bandwidth consumed (Mbit/s)
NSF_ISDN_Primary_Access	Nbr_lines_inUse

Voice application services in the backbone (see picture Figure 26: the services of the Voice application layer 4.0)

The services in the group “Access to VoiceCallHandling” allow to access the switching matrix and call handling , they are realized by ports to the switch (a switch port concentrates the voice circuits from/to the switching matrix). The switching ports (trunks) can be those of a local switch or of a transit switch .

For the case of interconnection with other operators (NLS4_o_Voice_traffic_AreaLevel_PointOfInterconnect, NLS4_o_Voice_traffic_Local_PointOfInterconnect) , the charging function of the switch is also exercised in order to allow for interoperator billing.

In summary the contributors are distributed using following drivers:

Network functions used to realize Access to VoiceCallHandling services	Driver used to attribute network functions to access to VoiceCallHandling services
NSF_Voice_call_CAE_charging	RoutedMin
NSF_Voice_call_CAE_Trunks	TimeSlot_capacity_used
NSF_Voice_call_Local_charging	RoutedMin
NSF_Voice_call_Local_Trunks	TimeSlot_capacity_used

The services in the group “VoiceCallHandling” result from three network stage functions:

NSF_Voice_call_CAE_Processing
 NSF_Voice_call_Local_Processing
 NSF_Voice_call_Local_charging

The driver used is “routed minutes” and it consists in determining the average nbr of times (=routing factor) a voice call handling type is using the network functions . The routed minutes result from multiplication of the routing factor with the amount of calls (expressed in minutes) exercising that voice call handling type.

Network function	Driver Name	
NSF_Voice_call_CAE_Processing	NLS4_0_Voice_traffic_AreaLevel_Collect	RoutedMin
	NLS4_0_Voice_traffic_AreaLevel_Complete	RoutedMin
	NLS4_0_Voice_traffic_AreaLevel_Terminate	RoutedMin
	NLS4_0_Voice_traffic_AreaLevel_Transit	RoutedMin
NSF_Voice_call_Local_charging	NLS4_0_Voice_traffic_Local_Collect	RoutedMin
	NLS4_0_Voice_traffic_Local_Complete	RoutedMin
	NLS4_0_Voice_traffic_Local_PointOfInterconnect	RoutedMin

NSF_Voice_call_Local_Processing	NLS4_0_Voice_traffic_Local_Collect	RoutedMin
	NLS4_0_Voice_traffic_Local_Complete	RoutedMin
	NLS4_0_Voice_traffic_Local_Terminate	RoutedMin

The services in the group “Voice transport” are emanating from layer 2.0 Backbone transport capacity (<=2M) which are distributed according to the consumed bandwidth.

Contributor to NLS4_x	Driver	NLS4_x element
NLS2_0_LocalBackboneCapacity<2M	Bandwidth consumed (Mbit/s)	NLS4_0_FixedSwitchedVoice_transport_National_offnet
		NLS4_0_SwitchedVoice_transport_LEX_CAE
		NLS4_1_Outgoing International Traffic - BGC Fixed
		NLS4_0_SwitchedVoice_transport_CAE_CAE
		NLS4_0_SwitchedVoice_transport_CAE_MSC
		NLS4_0_SwitchedVoice_transport_LEX_MSC
		NLS4_0_ISDN-PRA_access
NLS2_0_LocalBackboneCapacity=2M	Bandwidth consumed (Mbit/s)	NLS4_0_ISDN-PRA_access
		NLS4_0_RemotelyAggregatedVoice_transport
		NLS4_0_SwitchedVoice_transport_CAE_CAE
		NLS4_0_SwitchedVoice_transport_LEX_CAE
NLS2_0_IntrazonalBackboneCapacity<2M	Bandwidth consumed (Mbit/s)	NLS4_0_FixedSwitchedVoice_transport_National_offnet
		NLS4_0_SwitchedVoice_transport_LEX_CAE
		NLS4_1_Outgoing International Traffic - BGC Fixed
		NLS4_0_SwitchedVoice_transport_CAE_CAE
		NLS4_0_SwitchedVoice_transport_CAE_MSC
		NLS4_0_SwitchedVoice_transport_LEX_MSC
NLS2_0_IntrazonalBackboneCapacity=2M	Bandwidth consumed (Mbit/s)	NLS4_0_ISDN-PRA_access
		NLS4_0_RemotelyAggregatedVoice_transport
		NLS4_0_SwitchedVoice_transport_LEX_CAE
NLS2_0_IntraAreaBackboneCapacity<2M	Bandwidth consumed (Mbit/s)	NLS4_0_FixedSwitchedVoice_transport_National_offnet
		NLS4_1_Outgoing International Traffic - BGC Fixed
		NLS4_0_SwitchedVoice_transport_CAE_CAE
		NLS4_0_SwitchedVoice_transport_CAE_MSC
		NLS4_0_SwitchedVoice_transport_LEX_MSC
		NLS4_0_SwitchedVoice_transport_LEX_CAE
NLS2_0_IntraAreaBackboneCapacity=2M	Bandwidth consumed (Mbit/s)	NLS4_0_ISDN-PRA_access
		NLS4_0_RemotelyAggregatedVoice_transport
		NLS4_0_SwitchedVoice_transport_CAE_CAE
		NLS4_0_SwitchedVoice_transport_LEX_CAE
NLS2_0_InterCityBackboneCapacity<2M	Bandwidth consumed (Mbit/s)	NLS4_0_FixedSwitchedVoice_transport_National_offnet
		NLS4_1_Outgoing International Traffic - BGC Fixed
		NLS4_0_SwitchedVoice_transport_CAE_CAE
		NLS4_0_SwitchedVoice_transport_CAE_MSC
		NLS4_0_SwitchedVoice_transport_LEX_MSC

		NLS4_0_SwitchedVoice_transport_LEX_CAE
NLS2_0_InterCityBackboneCapacity=2M	Bandwidth consumed (Mbit/s)	NLS4_0_ISDN-PRA_access
		NLS4_0_SwitchedVoice_transport_CAE_CAE
		NLS4_0_SwitchedVoice_transport_LEX_CAE
NLS2_0_LocalTail<2M	Nbr_of_Customer_sites	NLS4_0_FixedSwitchedVoice_transport_National_offnet
NLS2_0_LocalTail=2M	Nbr_of_Customer_sites	NLS4_0_ISDN-PRA_access

The services in the group “VAS application” are in fact directly identified with a network function:

NSF_CallerIdentity_CallHandling	NLS4_0_CallerIdentity_CallHandling	direct
NSF_CallingCard_CallHandling	NLS4_0_CallingCard_CallHandling	direct
NSF_InteractiveVoiceResponse_CallHandling	NLS4_0_InteractiveVoiceResponse_CallHandling	direct
NSF_MessageWaitingIndicator_Inserting	NLS4_0_MessageWaitingIndicator_Inserting	direct
NSF_OtherAdvanced_CallHandling	NLS4_0_OtherAdvanced_CallHandling	direct
NSF_PrepaidCallingCard_CallHandling	NLS4_0_PrepaidCallingCard_CallHandling	direct
NSF_Service_Announcements_Playing	NLS4_0_Service_Announcements_Playing	direct
NSF_Televoiting_CallHandling	NLS4_0_Televoiting_CallHandling	direct
NSF_VirtualPrivateNetwork_CallHandling	NLS4_0_VirtualPrivateNetwork_CallHandling	direct
NSF_VoiceFeatures_SelfManaging	NLS4_0_VoiceFeatures_SelfManaging	direct
NSF_Voicemail&Messaging	NLS4_0_Voicemail&Messaging	direct
NSF_WakeUp_CallHandling	NLS4_0_WakeUp_CallHandling	direct

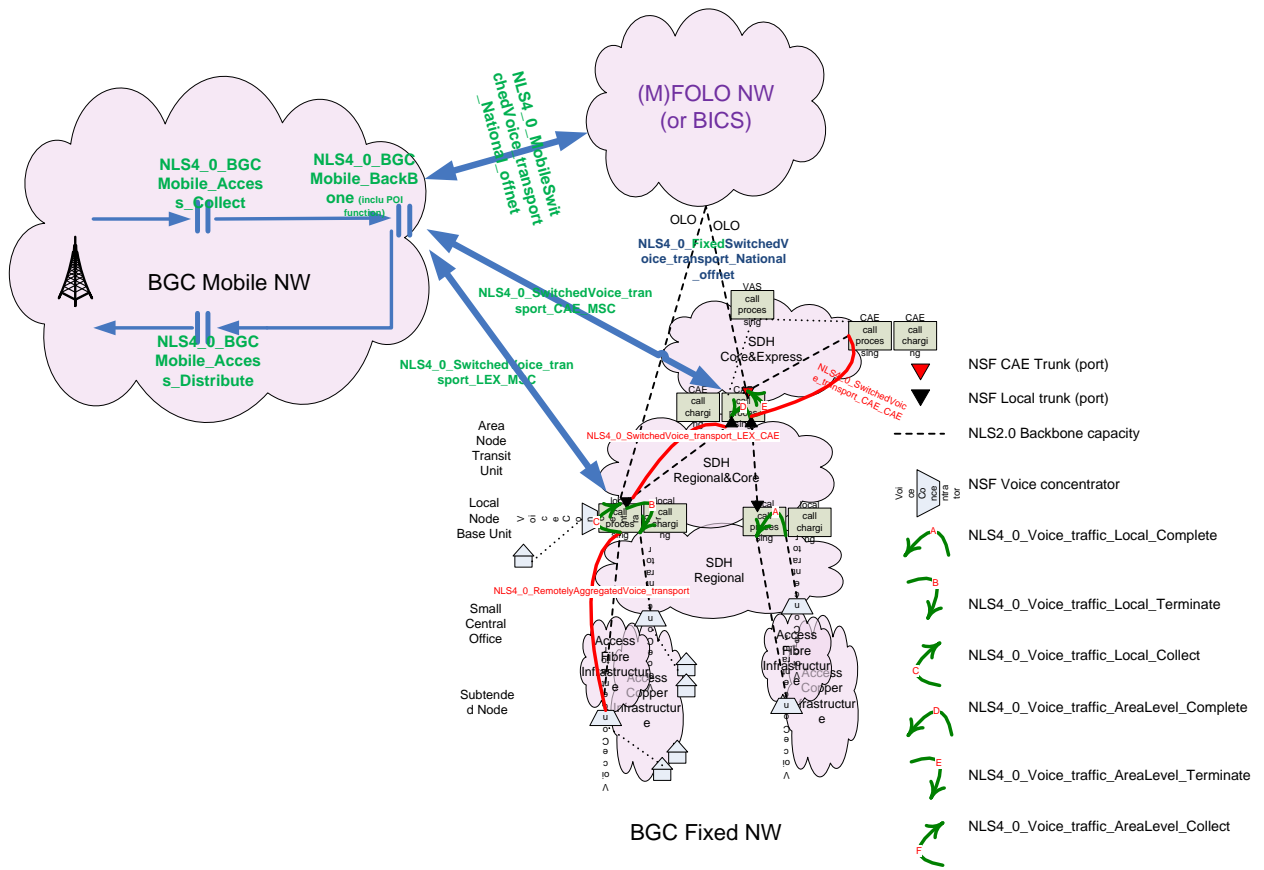

Figure 27: Switching Network

8 Annex I: SRW Flow Acronyms

SRW	Support, Retail, Whole Sale
BIPT	Belgian Institute for Postal services and Telecommunications
BTN	Business Transformation
CBU	Consumer Business Unit
CC	Costs Center
CCG	Costs Center Group
CP	Costs Pool
CWS	Carrier & WholeSale
EBU	Enterprise Business Unit
FAC	Fully Allocated Costs
HCA	Historical Cost Accounting
HMC	Human Manpower Cost
MOS	Material Out of Stock
NRA	National Regulatory Authority
REG	(Belgacom) Group Regulatory Affairs
SMP	Significant Market Power
SOG	Services & Other Goods
S&S	Staff & Support

9 Annex II: Network and IT Flows Acronyms

AC	Asset Class
ADSL	Asymmetric Digital Subscriber Line
ATM	Asynchronous Transfer Mode
BA	Basic Access
BAS	Broadband Access Server
BES	Belgacom European Solutions
BGC	Belgacom
BILAN	Belgacom Interconnection of LANs
BLES	Belgacom LAN Extension Service
BROBA	Belgacom Reference Offer for Bitstream Access
BROTSOLL	Belgacom Reference Offer for Terminating Segment of Leased Line
BVAS	Business Value Added Services
CAE	Coverage Exchange Area
CAPEX	CApital Expenditures
CP	Cost Pool
CPE	Customer Premises Equipment
CPU	Central Processing Unit
CWDM	Coarse Wavelength Division Multiplexing
DACS	Digital Analog Cross-connect System
DCN	Data Communication Network
DSL	Digital Subscriber Line
DSLAM	Digital Subscriber Line Access Multiplexer
DU	Dispatching Unit
DWDM	Dense Wavelength Division Multiplexing
EAA	Extra Access Area
EAL	Ethernet Access Line
EFM	Ethernet First Mile
ESS	Ethernet Service Switch
Ethane	ETHernet Aggregation NETwork
EUS	End User Service
FAC	Fully Allocated Costs
FIFA	Fast Internet Future Architecture

FTTC	Fiber To The Cabinet
FTTO	Fiber To The Office
Gb	Giga bit
Gbps	Giga bits per second
HW	HardWare
IAA	Intra Access Area
iDTV	interactive Digital TeleVision
IN	Intelligent Network
INCA	Integrated Cost Application
IO	In/Out
IP	Internet Protocol
IPVPN	Internet Protocol Virtual Private Network
ISAM	IP Subscriber Line Access Multiplexer
ISDN	Integrated Services Digital Network
LAN	Local Area Network
LDC	Local Distribution Center
LEX	Local Exchange
LL	Leased Line
LTE	Line Terminating Equipment
Mbit	Mega bit
MOLO	Mobile Other Licensed Operator
MPLS	MultiProtocol Label Switching
MSR	Multi Server Router
MUX	Multiplexer
MVAS	Mass Value Added Services
MWE	MicroWave Equipment
NE	Network Element
NGA	New Generation Access
NGN	New Generation Network
NLS	Network Layer Service
NTE	Network Terminating Equipment
NTP	Network Termination Point
NSF	Network Stage Function
OLO	Other Licensed Operator

OLTE	Optical Line Terminating Equipment
OPEX	OPERational Expenditure
OVH	Overhead
PDH	Plesiochronous Digital Hierarchy
PRA	Primary Access
PSTN	Public Switched Telephony Network
QoS	Quality of Service
RAM	Random Access Memory
ROP	Remote Optical Platform
SDH	Synchronous Digital Hierarchy
SDSL	Symmetric Digital Subscriber Line
STM	Synchronous Transport Module
TDM	Time Division Multiplexing
TV	TeleVision
VAS	Value Added Services
VDSL	Very high speed Digital Subscriber Line
VLAN	Virtual Local Area Network
VoD	Video on Demand
VoIP	Voice over Internet Protocol
VP	Virtual Path
VPLS	Virtual Private Local area network Service
VPN	Virtual Private Network
WDM	Wavelength Division Multiplexing
SDE	Service Delivery Engine
NEO	Network Engineering & Operations
COP	Customer Operations
CFO	Customer Field Operations
CIS	Customer ICT Services
ITS	Information Technology Services
APP	Architecture, Planning & Program Office